

Instruction Manual

Ionizer - Fan type

IZF21 / IZF31 series



The intended use of this product is to neutralize electrostatically charged objects.

1 Safety Instructions

These safety instructions are intended to prevent hazardous situations and/or equipment damage. These instructions indicate the level of potential hazard with the labels of "Caution," "Warning" or "Danger."

They are all important notes for safety and must be followed in addition to International Standards (ISO/IEC)⁽¹⁾, and other safety regulations.

⁽¹⁾ ISO 4414: Pneumatic fluid power - General rules relating to systems.

ISO 4413: Hydraulic fluid power - General rules relating to systems.

IEC 60204-1: Safety of machinery - Electrical equipment of machines. (Part 1: General requirements)

ISO 10218-1: Robots and robotic devices - Safety requirements for industrial robots - Part 1: Robots.

Refer to product catalogue, Operation Manual and Handling Precautions for SMC Products for additional information.

Keep this manual in a safe place for future reference.

	Caution	Indicates a hazard with a low level of risk, which if not avoided, could result in minor or moderate injury.
	Warning	Indicates a hazard with a medium level of risk, which if not avoided, could result in death or serious injury.
	Danger	Indicates a hazard with a high level of risk, which if not avoided, will result in death or serious injury.

Warning

- Always ensure compliance with relevant safety laws and standards.
- All work must be carried out in a safe manner by a qualified person in compliance with applicable national regulations.

Caution

- Ensure that the air supply system is filtered to 5 microns.

2 Specifications

2.1 Ionizer Specifications

Model	IZF21 (NPN)	IZF21-P (PNP)	IZF31 (NPN)	IZF31-P (PNP)	
Air Flow	1.8 m ³ /min		4.4 m ³ /min		
Ion generation method	Corona discharge				
Applied voltage method	DC				
Applied voltage	±5 kV				
Offset voltage (ion balance)	±5 V				
Power supply voltage	24 VDC ±10%				
Current consumption	0.9 A or less		1.3 A or less		
Input signals	Connected to	0 V	+24 V	0 V	+24 V
	Voltage	5 VDC or less	19 to 24 VDC	5 VDC or less	19 to 24 VDC
Output signals	Current consumption	5 mA max.			
	Load current	100 mA max.			
Residual voltage	Residual voltage	1 V or less (at 100 mA load)			
	Max. applied voltage	26.4 VDC	-	26.4 VDC	-
Ambient temperature	0 to 50°C (no freezing)				
Storage temperature	-10 to 60°C				
Ambient humidity	35 to 80% RH (no condensation)				
Materials	Case: ABS / Stainless steel Emitter: Tungsten				
Weight	430 g		605 g		

3 Installation

3.1 Installation

Warning

- Do not install the product unless the safety instructions have been read and understood.
- Provide space for maintenance, inspection and wiring.**
Install the product in consideration of the connector and the emitter cartridge mounting so that there is enough space for emitter maintenance, inspection and wiring.

To avoid unreasonable stress applied to the connector, bending of the cable should not be less than the minimum bending radius. If the cable is bent in an acute angle or load is applied to the cable repeatedly, it may cause malfunction or wire damage.

- Mount the product on a flat surface.**

Mounting on an uneven surface will apply excess force to the frame or case, which leads to damage or failure. Do not drop the product or subject it to a strong impact. This may cause an injury or accident.

- Avoid using in a place where noise (electromagnetic wave and surge) is generated.**

If the product is used in an environment where noise is generated, it may lead to deterioration or damage of the internal elements. Take measures to prevent noise at its source and avoid power and signal lines from coming into close contact.

- Use the correct tightening torque.**

If the screws are tightened in excess of the specified torque range, it may damage the mounting screws, mounting brackets, etc. If the tightening torque is insufficient, the mounting screws and brackets may become loose.

- Do not adhere tape or labels onto the product body.**

If the tape or label contains conductive adhesive or reflective paint, it is possible that due to the dielectric effect, charge could build up causing an electro-static discharge or electrical leakage.

- Be sure to cut off the power supply before installing or adjusting the product.**

Caution

- Provide sufficient space at the rear of the ionizer to allow the fan to absorb air.**

This product ventilates using a fan motor. If there are obstacles such as a wall on the rear side (air absorption side) of the ionizer, ventilation will be obstructed, decreasing the static neutralization performance. Install the ionizer so that its rear surface is at least 20 mm (for IZF21) or 30 mm (for IZF31) away from any obstacles.

- Make sure to confirm the effect of static neutralization after installation.**

The effect of the static neutralization varies depending on the surrounding installation and operating conditions. Confirm the effect of the static neutralization after installation.

- When installing ionizers which operate in DC mode (one polarity, positive or negative) close together, they should be positioned at least 2 m apart.**

The offset voltage (ion balance) may not be controlled by the built-in sensor due to the ions discharged from the other ionizer.

- Do not apply excessive external force to the finger guard on the air absorption side.**

If an excessive external force is applied to the finger guard (including the filter holder) on the air absorption side, it may be damaged. Do not apply an external force of more than 50 N.

3 Installation (continued)

3.2 Precautions for Installation

Be sure to disconnect the power supply before installing the product.

The emitter cartridge can be mounted / removed with one touch. However, it is also possible to secure it with a screw as required. To secure the emitter cartridge with a screw, use an M3 x 0.5 x 12 mm cross recessed round head screw (the screw needs to be supplied by the user). The recommended tightening torque is 0.25 to 0.35 N•m.

Install the ionizer so that the emitter cartridge can be removed for maintenance and replacement of the emitters.

To remove the emitters for cleaning or replacement, pull it to the air blow side while the part A of the emitter cartridge is being pressed. (If the emitter cartridge is secured with a retaining screw, remove the screw before removing the emitter cartridge).

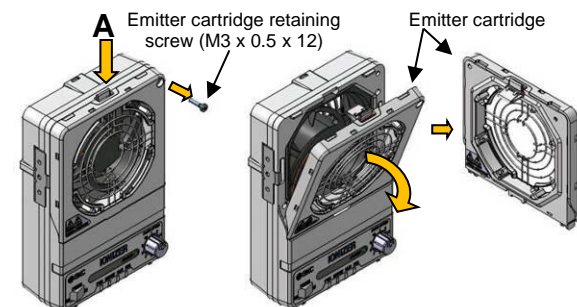

3.3 Installation of ionizer

1) Installation with bracket

When installing the ionizer with a bracket, secure it with M5 screws using the mounting holes in the bottom of the bracket (screws to be supplied by the user).

Refer to the Outline Dimensions in the operation manual for details.

The angle adjustment range of the bracket is 45 degrees in direction A, and 90 degrees in direction B.

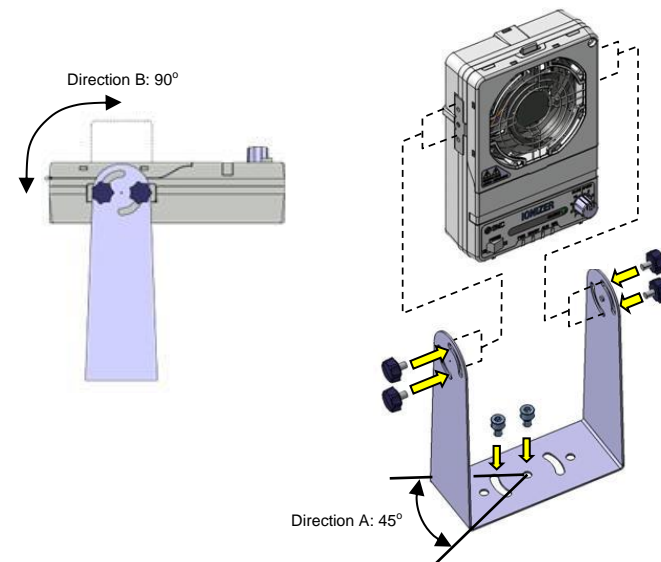

2) Installation without bracket

If a bracket is not used, install the product using the M4 screw holes on both sides of the body. Be sure to secure both sides of the body when fixing the ionizer. (If the product is fixed on one side only, the product body may be damaged. The screws need to be prepared by the user.)

Refer to the Outline Dimensions in the operation manual for details.

The recommended tightening torque is 1.3 to 1.5 N•m.

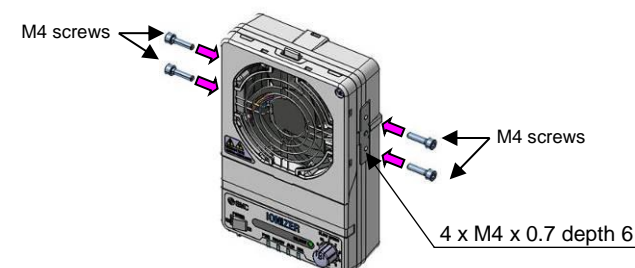

3 Installation (continued)

3.4 Environment

Warning

- Do not use in an environment where corrosive gases, chemicals, salt water or steam are present.
- Do not use in an explosive atmosphere.
- Do not expose to direct sunlight. Use a suitable protective cover.
- Do not install in a location subject to vibration or impact. Check the product specifications.
- Do not mount in a location exposed to radiant heat.
- Keep within the specified ambient temperature range.
The specified ambient temperature range for the ionizer is 0 to 50 °C, and for the AC adapter is 0 to 40 °C. Avoid sudden temperature changes even within the specified ambient temperature range, as it may cause condensation.

- Do not use this product in an enclosed space.**

This product utilizes the corona discharge phenomenon. Although the amount is very small, Ozone and NOx are generated. Do not use in an enclosed space.

- Environments to avoid**

Never use or store under the following conditions. These may cause an electric shock, fire, etc.

- Areas where the ambient temperature exceeds the operating temperature range.
- Areas where the ambient humidity exceeds the operating humidity range.
- Areas where abrupt temperature changes may cause condensation.
- Areas where corrosive gas, flammable gas or other volatile flammable substances are stored.
- Areas where the product may be exposed to conductive powder such as iron powder or dust, oil mist, salt, organic solvent, machining chips, particles or cutting oil (including water and any liquids), etc.
- Paths of direct air flow, such as air conditioners.
- Enclosed or poorly ventilated areas.
- Locations which are exposed to direct sunlight or heat radiation.
- Areas where strong electromagnetic noise is generated, such as strong electrical and magnetic fields or supply voltage spikes.
- Areas where the product is exposed to static electricity discharge.
- Locations where strong high frequency is generated.
- Locations that are subject to potential lightning strikes.
- In an area where the product may receive direct impact or vibration.
- Areas where the product may be subjected to forces or weight that could cause physical deformation.

3.5 Wiring

Warning

- Before wiring, ensure that the power supply capacity meets the specification and that the voltage is within the specification.
- To maintain product performance, the power supply shall be UL listed Class 2 certified by National Electric Code (NEC) or evaluated as a limited power source provided by UL60950.
- To maintain the product performance, ground the product with an earth ground cable with a resistance of 100 Ω or less according to this manual.
- Remove the power supply before wiring (including the connector plug in/out).
- Ensure the safety of wiring and surrounding conditions before supplying power.
- Do not connect or disconnect the connectors (including power source) while the power is supplied. The ionizer may malfunction.
- Malfunctions stemming from noise may occur if the wire is installed in the same route as that of power or high-voltage cable. Route the ionizer wires independently.
- Confirm that the wiring is correct before operation. Incorrect wiring will lead to malfunction or may damage the controller or its peripheral devices depending on the seriousness of the wiring error.

3.6 Wiring Diagram

Wire cables according to the connection circuit and wiring diagram.

Be sure to connect the ground terminal (F.G.) with a ground resistance of 100 Ω or less.

The ground terminal (F.G.) is used as an electrical reference potential for static neutralization. If the ground terminal is not grounded, the ionizer will not be able to achieve the optimal offset voltage (ion balance).

In addition, make sure to wire 2 brown cables and 2 blue cables for supplying power to the ionizer.

3 Installation (continued)

Connection circuit NPN Input / output

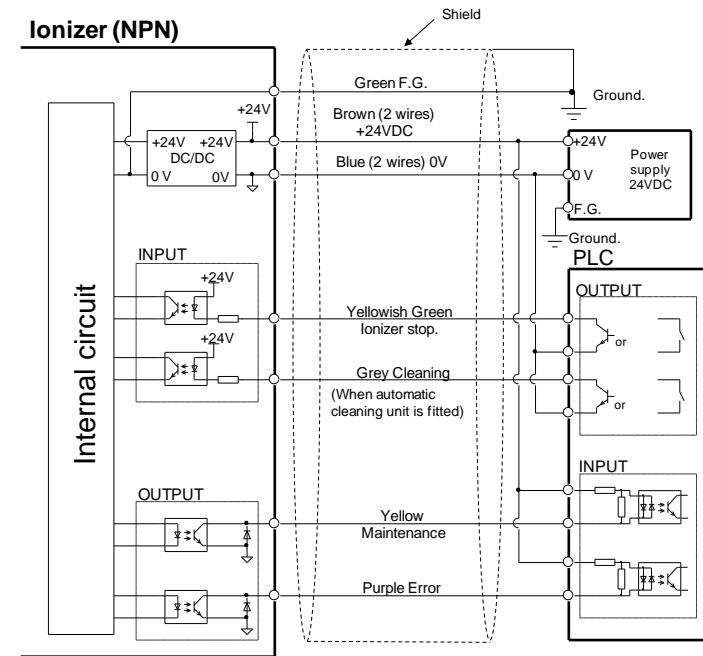

PNP Input / output

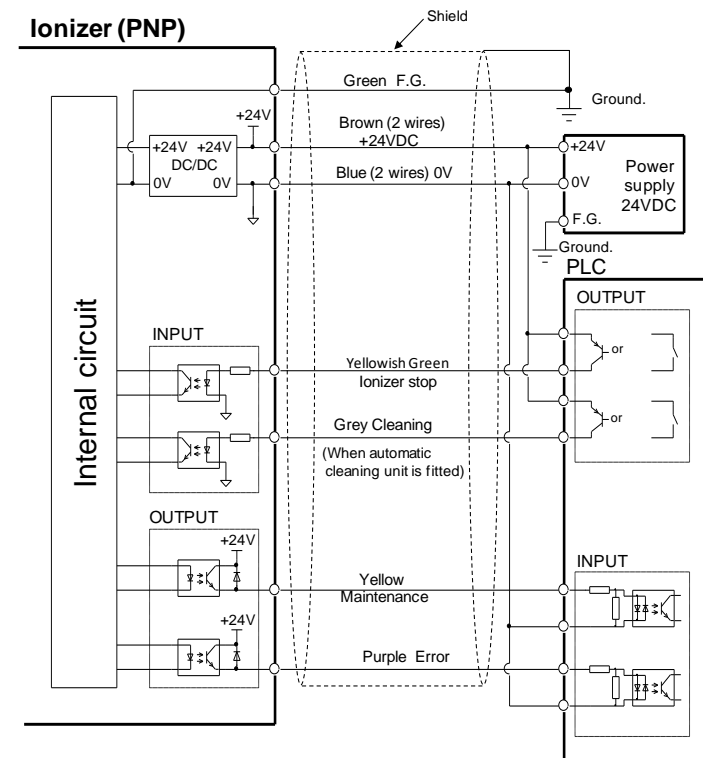

3.7 Power Supply Cable

Install the cables with a radius greater than the minimum bending radius (38 mm) to prevent excessive stress from being applied to the cable and/or connectors. Note: This is the allowable bend radius at 20 °C.

Unused wires should be cut short or insulated to avoid contacting with other wires.

Be sure to connect the 2 brown cables in which a voltage of +24 VDC is supplied and 2 blue cables in which 0 V is supplied to satisfy the current capacity requirements.

3 Installation (continued)

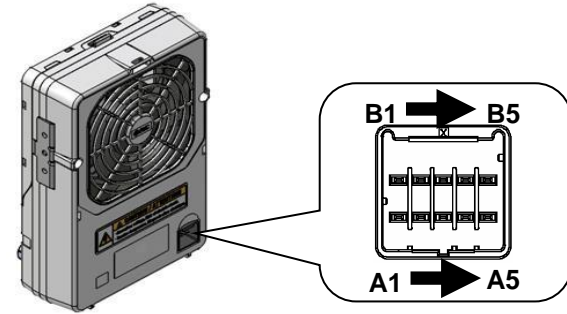

3.8 Wiring Connections

Pin No.	Wire colour	Signal Name	Signal Direction	Description
A1	Brown	+24 VDC	IN	Power Supply for Ionizer
B1				
A2	Blue	0 V	IN	
B2				
A3	Green	F.G.	-	Connect to Ground (resistance 100 Ω or less). Used as a reference potential for ionizer.
B3	Yellow Green	Ionizer stop signal	IN	Signal input to turn ON/OFF the fan ventilation and ion generation. NPN: Stopped by connecting to 0 V. PNP: Stopped by connecting to 24 VDC. (continues to operate when disconnected).
A4	Grey	Cleaning signal	IN	If the automatic cleaning (option) is mounted, emitters are cleaned when the signal is input. The ion generation and fan will be stopped during cleaning.
B4	Yellow	Maintenance signal	OUT (contact A)	Signal is ON when emitter contamination or wear is detected, when balance cannot be adjusted by the built-in sensor, or when the automatic cleaning is performed (option).
A5	Purple	Error signal	OUT (contact B)	Signal is OFF during power supply failure, incorrect high voltage, fan motor failure, CPU failure, excessive output current, emitter cartridge mounting failure, or automatic cleaning failure (option) is detected. (Signal is ON when there is no problem).
B5	White	Not used	-	-

3.9 Wiring of the AC Adapter

Perform F.G. connection with the ground terminal (F.G.) of the AC cable when an AC adapter is used. If the AC cable is plugged in, plug it into a grounded outlet. Always use an AC cable with ground terminal if it is prepared by the user.

The ground terminal (F.G.) is used as an electrical reference potential for static neutralization. If the ground terminal is not grounded, the ionizer will not be able to achieve the optimal offset voltage (ion balance). External input and output cannot be used when the AC adapter is being used.

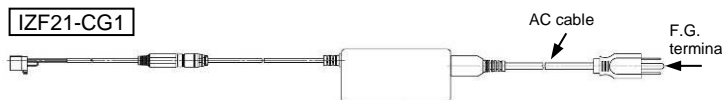

Note) AC cable is only for use in Japan.
(Rated voltage: 125 V, Plug: JIS C8303, Inlet: IEC60320-C6)

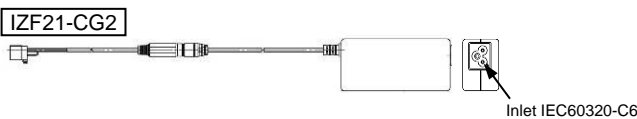

Note) The AC cable is not included. Please prepare an AC cable that conforms to the standards for each country.

4 Functions

4.1 Summary of Product Parts

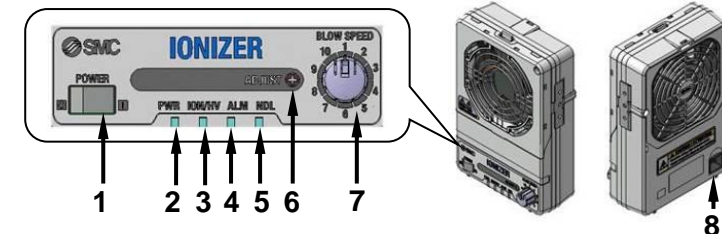

No.	Name	Panel Display	Type	Description
1	Power supply switch	POWER	Switch	Switch to turn ionizer ON and OFF.
2	Power supply indicator	PWR	LED (Green/Red)	Green LED is ON when power supply is ON, green LED flashes when power supply is abnormal. Red LED flashes when CPU is abnormal.
3	Static neutralization operation / Incorrect high voltage	ION / HV	LED (Green/Red)	Green LED is ON when static neutralization is operating, red LED is ON when incorrect high voltage is detected. Red LED flashes when CPU is abnormal.
4	Error indicator	ALM	LED (Red)	Red LED is ON constantly during fan motor failure or automatic cleaning failure is detected. Red LED flashes when CPU is abnormal.
5	Maintenance indicator	NDL	LED (Green/Red)	Green LED is ON when emitter contamination is detected. Red LED is ON when emitter cartridge mounting failure is detected. Red LED flashes when automatic cleaning failure or CPU failure is detected. Green LED flashes during automatic cleaning operation.
6	Balance adjustment	ADJUST	Trimmer	Trimmer for offset voltage (ion balance) adjustment. Refer to operation manual.
7	Air flow adjustment	BLOW SPEED	Rotary switch	Switch for adjustment of air flow with fan. Refer to operation manual.
8	Connector	-	Connector	Connector for power supply, F.G. and input/output signals.

4.2 Alarm Function

If abnormal functions occur during operation of the ionizer, the user will be alerted by the external output signal and by the LED operation.

Alarm Name	Output signal	LED ON	LED (flashes at 1Hz)	Ionizer operation during alarm	Description	Action to reset alarm
Power supply failure	Error signal OFF (B contact)	-	PWR (green)	Stop	Connected power supply voltage is outside of specification.	Resets automatically
Incorrect high voltage	Error signal OFF (B contact)	ION / HV (red)	-	Stop	Error in high voltage discharge circuit.	Ionizer stop signal ON/OFF. Cycle power ON/OFF.
Fan motor failure	Error signal OFF (B contact)	ALM (red)	-	Stop	Incorrect ionizer operation due to foreign matter in fan motor.	Ionizer stop signal ON/OFF. Cycle power ON/OFF.
CPU failure	Error signal OFF (B contact)	-	PWR ION/HV ALM NDL (red)	Stop	CPU error due to noise, etc.	Cycle power ON/OFF.
Output signal over current	Error signal OFF (B contact). Maintenance signal ON (A contact)	-	-	Continue	Protection circuit activated by excess current in output signal.	Resets automatically
Maintenance warning	Maintenance signal ON (A contact)	NDL (green)	-	Continue	Static neutralization performance reduced due to emitter contamination, damage or wear.	Ionizer stop signal ON/OFF. Cycle power ON/OFF.
Emitter cartridge mounting failure	Error signal OFF (B contact)	NDL (red)	-	Stop	Emitter cartridge not fitted.	Cycle power ON/OFF.
Automatic cleaning failure	Error signal OFF (B contact)	ALM (red)	NDL (red)	Stop	Error during automatic cleaning operation.	Cycle power ON/OFF.

4 Functions (continued)

- Power supply failure**
 If the power supply connected to the ionizer is not within the range of 24 V +/-10%, the abnormal signal will be turned OFF (ON when it is normal), and the PWR LED (green) will flash to indicate the error. When failure occurs, the fan motor rotation and ion generation will be stopped. To resolve the error, reset the product automatically and connect a power supply which provides a power supply voltage of 24 V +/-10%.
- Incorrect high voltage**
 When an incorrect electrical discharge is generated during the ionizer operation, the abnormal signal will be turned OFF (ON when it is normal), and the ION/HV LED (red) will light up to indicate the error. If a failure occurs, the fan motor rotation and ion generation will stop. The incorrect electric discharge could be caused by condensation or dust on the emitters. To resolve the error, input the ionizer stop signal and after remedying the cause of the incorrect electric discharge supply power again.
- Fan motor failure**
 If the fan motor malfunctions during ionizer operation, the abnormal signal will be turned OFF (ON when it is normal), and the ALM LED (red) will turn ON to indicate the error. If failure occurs, the fan motor rotation and ion generation will stop. The fan motor failure could be caused by failure of the rotational operation due to foreign matter entwined in the fan motor. To resolve the error, input the ionizer stop signal and after removing the foreign matter supply power again.
- CPU failure**
 If the CPU makes an abnormal operation due to noise or other reasons, the abnormal signal will be turned OFF (ON when it is normal), and the PWR, ION/HV, ALM, and NDL LED (red) will flash to indicate an error. If failure occurs, the fan motor rotation and ion generation will stop. To prevent noise, perform the following actions and countermeasures.
 - Position the ionizer away from any noise source.
 - Route the power line and cables for the ionizer separately.
 - Install a noise filter to the power supply of the ionizer.
 To resolve the error, after fixing the cause of the error, supply power again.
- Output signal over current**
 When excessive current flows to the output circuit, the output will be blocked to protect the circuit and the abnormal signal will be turned OFF (ON when it is normal) to indicate an error. The ionizer operates even when excessive current is generated in the output circuit. To resolve the error, reset the product automatically by reducing the current to the output circuit to 100 mA or less.
- Maintenance warning**
 The maintenance signal will turn ON when contamination, wear or breakage of the emitters is detected. The NDL LED (green) will turn ON to indicate that cleaning or replacement of the emitters is required. The ionizer operates even when the maintenance warning is generated. When emitters are contaminated, the error can be solved by cleaning them. However, when they are worn out or damaged, it is necessary to replace the emitter cartridge with a new one. To resolve the error, input the ionizer stop signal and after remedying the cause of the error supply power again.
- Emitter cartridge mounting failure**
 If the emitter cartridge is not mounted; or if power is supplied while the emitter cartridge is not mounted in the correct position; or when the correct emitter cartridge mounting cannot be detected due to foreign matter inside the terminals which detect connection of the emitter cartridge, the abnormal signal will be turned OFF (ON when it is normal), and NDL LED (red) will turn ON to indicate an error. When failure occurs, the fan motor rotation and ion generation will stop. To solve the error, remount the emitter cartridge in the correct position or remove the foreign matter adhered to the terminals and supply power again.
- Automatic cleaning failure (for product with an automatic cleaning unit)**
 If the cleaning operation is not completed in the specified time, the abnormal signal will be turned OFF (ON when it is normal), the ALM LED (red) will turn ON, and the NDL LED (red) will flash to indicate an error.

4 Functions (continued)

The automatic cleaning operation failure could be caused by foreign matter entwined in the cleaning parts, or by malfunction of the magnetic type origin detection sensor due to environmental magnetic field. To resolve the error, after removing the foreign matter and/or magnetic field, supply power again.

4.3 Other Functions

- Offset Voltage Performance Maintaining Function
- Ion Balance Sensor
- Averaging Function
- Automatic Cleaning Unit (option)
- Louver (option)
- Filter (option)

For further details refer to the operation manual on the SMC website (URL: <https://www.smcworld.com>).

5 Settings

5.1 Adjustment of Offset Voltage

Although the offset voltage (ion balance) of this product has been adjusted before shipping, readjustment may be required depending on the installation environment or conditions. Adjustment can be performed using a balance adjusting trimmer which is labelled as ADJUST.

When adjusting the offset voltage (ion balance), use a measuring instrument such as a charge plate monitor. As described in "Averaging Function" in the operation manual, this product exchanges the polarity of voltage applied to the emitters. After adjusting the offset voltage (ion balance), supply power again to exchange the polarity of voltage applied to the emitters. Then, adjust the offset voltage (ion balance) again after rotating the trimmer to the end and returning it. In addition, adjustment of the offset voltage (ion balance) may be required after replacing the emitter cartridge.

Rotating the balance adjusting trimmer in a clockwise direction increases positive ions and rotating it in a counter-clockwise direction increases negative ions.

Balance adjusting trimmer

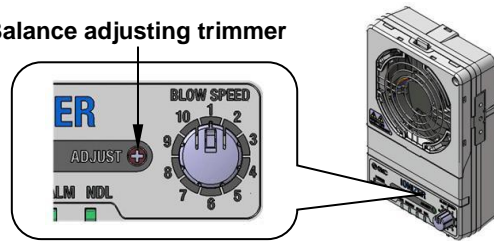

5.2 Adjustment of Air Flow

The air flow can be adjusted using the air flow adjustment dial labelled as BLOW SPEED.

Details of the scales of the air flow adjustment dial and the air flow rate are shown in the table below.

SW	Air flow rate [m ³ /min]	
	IZF21	IZF31
1	0.4	1.3
2	0.5	1.7
3	0.6	1.9
4	0.7	2.3
5	0.8	2.5
6	0.9	2.7
7	1.1	3.2
8	1.4	3.7
9	1.7	4.2
10	1.8	4.4

Air flow adjustment dial

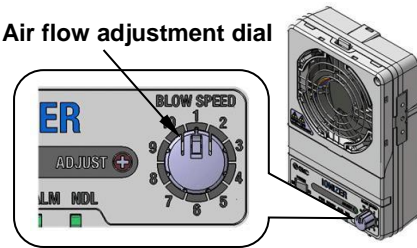

The air flow adjustment dial can be removed to avoid unnecessary setting change.

To remove the air flow adjustment dial, pull it out while holding part A. When inserting the air flow adjustment dial, make sure that the D-shaped part of the rotary switch on the body is aligned with the D-shaped part of the dial mounting part. If the D-shaped part is inserted forcibly while it is not aligned with the appropriate part, the rotary switch and/or air flow adjustment dial may be damaged.

5 Settings (continued)

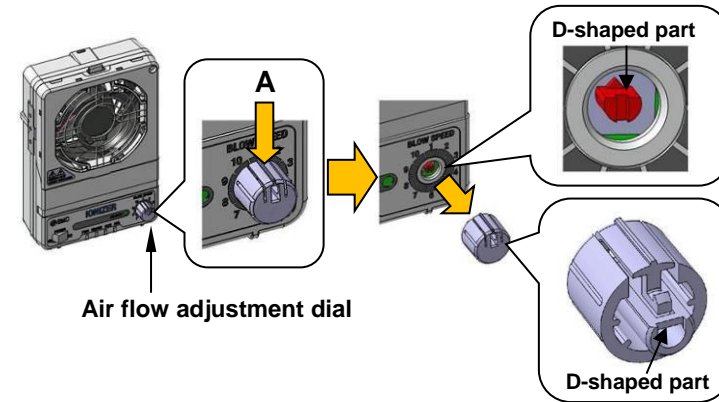

6 How to Order

Refer to the operation manual or catalogue on the SMC website (URL: <https://www.smcworld.com>) for "How to Order" information.

7 Outline Dimensions (mm)

Refer to the operation manual or catalogue on the SMC website (URL: <https://www.smcworld.com>) for "Outline dimensions".

8 Maintenance

8.1 General Maintenance

Caution

- Not following proper maintenance procedures could cause the product to malfunction and lead to equipment damage.
- If handled improperly, compressed air can be dangerous. Maintenance of pneumatic systems should be performed only by qualified personnel.
- Before performing maintenance, turn off the power supply and be sure to cut off the supply pressure. Confirm that the air is released to atmosphere.
- After installation and maintenance, apply operating pressure and power to the equipment and perform appropriate functional and leakage tests to make sure the equipment is installed correctly.
- Do not make any modification to the product.
- Do not disassemble the product, unless required by installation or maintenance instructions.

8.2 Dirt Detection and Cleaning of Emitter

If the ionizer is used for an extended period of time, contamination such as dust will stick to the emitters, reducing the static neutralization performance.

This product has a function which constantly monitors the emitter contamination. When emitter contamination is detected, it is indicated by the maintenance signal and LED.

The emitters should be cleaned when contamination is detected, or at least once a week.

(The cleaning frequency varies depending on the environment where the ionizer is installed).

The emitters can be cleaned manually or automatically (option). If the ionizer performance does not recover after cleaning the emitters, it can be assumed that the emitters are damaged or worn out. If wear or damage of the emitters is detected, replace the emitter cartridge.

8.3 Replacement of Emitter Cartridge

If the emitters are worn or damaged, replace the emitter cartridge. Before replacing the emitters, make sure that the power supply is OFF and confirm that the fan motor has stopped. The fan motor will rotate due to inertial force even when the power supply is disconnected. Confirm that the fan has stopped before performing maintenance. Remove the emitter cartridge by pulling it out towards the air blow side while part A of the emitter cartridge is pressed. (If the emitter cartridge is secured with a retaining screw, remove the screw before removing the emitter cartridge).

8 Maintenance (continued)

Remount the emitter cartridge into the body by following the reverse procedure for removal. As the emitter cartridge and the body have terminals for confirming the connection and for applying high voltage to the emitters, remount the emitter cartridge into the body so that the terminals make contact. Be careful that no contact failure or short circuit caused by adhesion of foreign matter occurs when connecting the terminals. Make sure that no foreign matter is adhered to the connector of the body. The recommended tightening torque for the emitter cartridge retaining screw is 0.25 to 0.35 N•m.

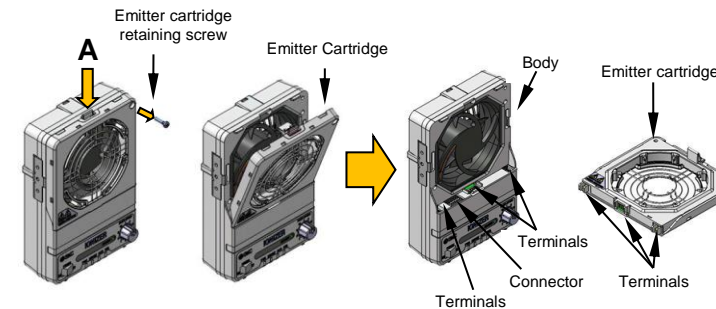

8.4 Manual Cleaning

Clean the emitters using a cleaning kit [IZS30-M2] or a cotton bud soaked in alcohol.

Before cleaning the emitters, make sure that the power supply is OFF and confirm that the fan motor has stopped. If cleaning is performed before the fan motor stops, it may cause injury.

In addition, if the emitters are touched while they are energized, it may cause electric shock or injury. As the emitter ends are sharp, be careful not to touch them. Otherwise, it may cause injury.

- Replacement and cleaning of the emitter cartridge -

- 1) Turn off the power supply to the ionizer. The fan motor rotation does not stop immediately due to inertial force even when the power supply is disconnected. Confirm that it has stopped before moving to the next step.
- 2) Remove the emitter cartridge by pulling it out towards the air blow side while part A of the emitter cartridge is pressed. (If the emitter cartridge is secured with a retaining screw, remove the screw before removing the emitter cartridge.)

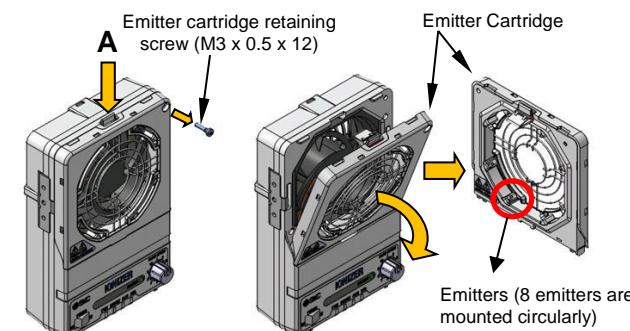

Caution

Do not touch the emitters during cleaning.

- 3) 8 emitters are mounted on the inside of the emitter cartridge. Clean all of them.

Using the cleaning kit, saturate the felt with industrial alcohol, insert it into the emitters and rotate several times to clean. If the dirt does not come off, use the rubber grindstone to clean the emitters in the same way. After that, use the felt again saturated with industrial alcohol to finish the cleaning.

If a cleaning kit is not available, saturate a cotton swab with alcohol to clean the emitters.

Caution High Voltage

This product contains a high voltage generation circuit. When performing maintenance inspection, be sure to confirm that the power supply to the ionizer is turned off. Never disassemble or modify the product, as this can cause loss of product functionality, and there is also a risk of electric shock and earth leakage.

8 Maintenance (continued)

The industrial alcohol used should be reagent ethanol class 1 99.5 vol% or greater.

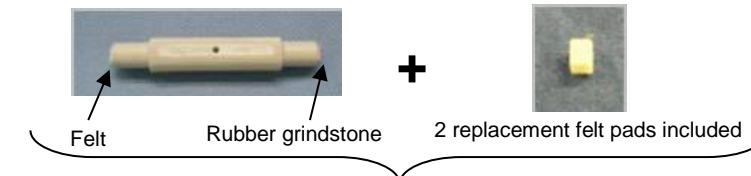

Cleaning kit (IZS30-M2)

The cleaning kit has a felt pad and a rubber grindstone. Choose the felt or rubber grindstone depending on the level of contamination to effectively clean the emitters.

Felt: Use for normal cleaning.

Rubber grindstone: Use if dirt is hard and stuck to the emitters and it is not possible to remove with felt.

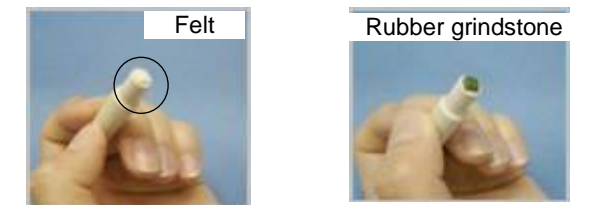

- 4) Fit the emitter cartridge back in its original position by following the removal procedure in reverse.

Remount the emitter cartridge so that the terminals on the body contact with the terminals on the emitter cartridge. Be careful that no contact failure or short circuit caused by adhesion of foreign matter occurs when connecting the terminals. Make sure that no foreign matter is adhered to the body of the connector.

The recommended tightening torque for the emitter cartridge retaining screw is 0.25 to 0.35 N•m.

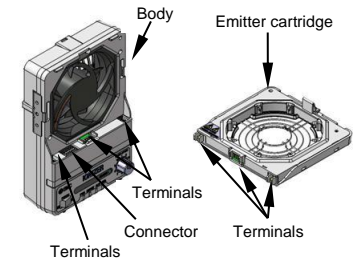

9 Limitations of Use

9.1 Limited warranty and disclaimer/compliance requirements

Refer to Handling Precautions for SMC Products.

10 Product Disposal

This product shall not be disposed of as municipal waste. Check your local regulations and guidelines to dispose this product correctly, in order to reduce the impact on human health and the environment.

11 Contacts

Refer to www.smcworld.com or www.smc.eu for your local distributor / importer.

SMC Corporation

URL : <https://www.smcworld.com> (Global) <https://www.smc.eu> (Europe)
SMC Corporation, 4-14-1, Sotokanda, Chiyoda-ku, Tokyo 101-0021, Japan
Specifications are subject to change without prior notice from the manufacturer.
© 2021 SMC Corporation All Rights Reserved.
Template DKP50047-F-085M