

# 5 Port Solenoid Valve

## Series VQ4000

Metal Seal

Rubber Seal



### Space-saving profile

Clean space-saving design with all pilot valves concentrated to one side with no protrusions in any direction

Space-saving — 40% less  
Capacity-saving — 50% less  
(In-house comparison)

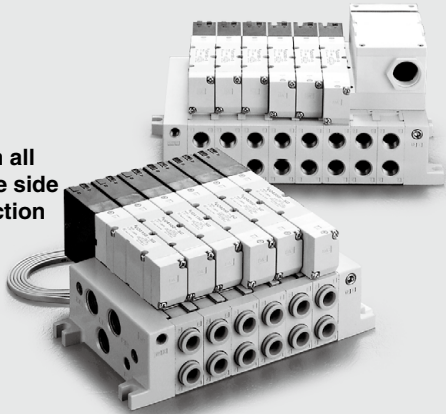

### Compact with large flow capacity

(Ideal for driving cylinders up to  $\phi 140$ )

### Built-in One-touch fittings for easier piping

### Outstanding response times and long service life

(Metal seal with indicator light/surge suppressor)  
**VQ4100** 17 mS (Single)  
**VQ4200** 12 mS (Double)  
 Accuracy  $\pm 3$  mS  
 \* According to SMC life test conditions  
 100 million cycles

### A variety of common wiring methods are standardized.

<Plug-in type>

<b>F</b> kit (D-sub connector) P.1072 	<b>T</b> kit (Terminal block box) P.1076 
<b>L</b> kit (Lead wire) P.1080 	<b>S</b> kit (Serial transmission) P.1089 

Enclosure IP65 compatible

### Enclosure IP65 compliant Dusttight/Low jetproof type

### Cylinder Speed Chart

Use as a guide for selection. Please confirm the actual conditions with SMC Sizing Program.

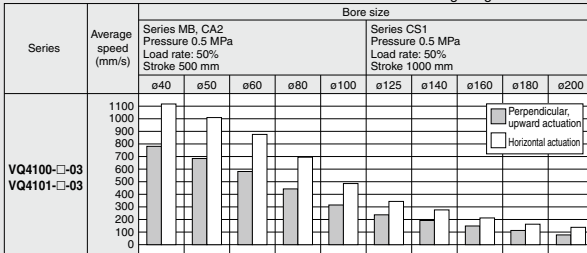

\* It is when the cylinder is extending that is meter-out controlled by speed controller which is directly connected with cylinder, and its needle valve with being fully open.  
 \* The average velocity of the cylinder is what the stroke is divided by the total stroke time.  
 \* Load factor:  $((\text{Load weight} \times 9.8) / \text{Theoretical force}) \times 100\%$

#### System Components

Speed controller	Silencer	SPG (Steel pipe) dia. x Length
AS420-03	AN30-03	10A x 1m

### Individual wiring type

<Plug lead type>

<b>C</b> kit (Connector) P.1090 
---

Enclosure IP65 compatible Grommet type

SJ
SY
SV
SYJ
SZ
VF
VP4
S0700
VQ
<b>VQ4</b>
VQ5
VQC
VQC4
VQZ
SQ
VFS
VFR
VQ7

# Base Mounted

## Plug-in/Plug Lead Single Unit

# Series VQ4000



### Model

Series	Configuration	Model	Port size	Flow characteristics						Response time (ms)			Weight (kg)			
				1 → 4/2 (P → A/B)			4/2 → 5/3 (A/B → EA/EB)			Standard 1 W	Low wattage 0.5 W	AC				
				C [dm <sup>3</sup> (l/min)]	b	Cv	C [dm <sup>3</sup> (l/min)]	b	Cv							
VQ4000	2 position	Single	Metal seal	VQ410 0	6.2	0.19	1.5	6.9	0.17	1.7	20 or less	22 or less	22 or less	0.23 (0.29)		
			Rubber seal	VQ410 1	7.2	0.43	2.1	7.3	0.38	2.0	25 or less	27 or less	27 or less			
		Double	Metal seal	VQ420 0	6.2	0.19	1.5	6.9	0.17	1.7	12 or less	14 or less	14 or less			
			Rubber seal	VQ420 1	7.2	0.43	2.1	7.3	0.38	2.0	15 or less	17 or less	17 or less			
		3 position	Closed center	Metal seal	VQ430 0	5.9	0.23	1.5	6.3	0.18	1.6	45 or less	47 or less		47 or less	0.28 (0.34)
				Rubber seal	VQ430 1	7.0	0.34	1.9	6.4	0.42	1.9	50 or less	52 or less		52 or less	
	Exhaust center		Metal seal	VQ440 0	6.2	0.18	1.5	6.9	0.17	1.7	45 or less	47 or less	47 or less			
			Rubber seal	VQ440 1	7.0	0.38	1.9	7.3	0.38	2.0	50 or less	52 or less	52 or less			
	3 position	Pressure center	Metal seal	VQ450 0	6.2	0.18	1.6	6.4	0.18	1.6	45 or less	47 or less	47 or less	0.28 (0.34)		
			Rubber seal	VQ450 1	7.0	0.38	1.9	7.1	0.38	2.0	50 or less	52 or less	52 or less			
		Double check	Metal seal	VQ460 0	2.7	—	—	3.7	—	—	55 or less	57 or less	57 or less			
			Rubber seal	VQ460 1	2.8	—	—	3.9	—	—	62 or less	64 or less	64 or less			

Note 1) Value for valve on sub-plate and cylinder port Rc 3/8

Note 2) Based on JIS B 8375-1981 Supply pressure: 0.5 MPa, with indicator light and surge voltage suppressor, clean air. This will change depending on pressure and air quality.) The value when ON for the double type.

Note 3) Values inside ( ) indicate the weight of plug lead units.

Table: Without sub-plate, With sub-plate: Add 0.41 kg for plug-in type, 0.30 kg for plug lead type.

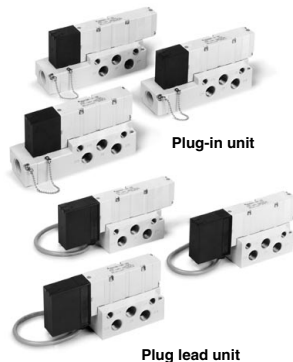

Plug-in unit

Plug lead unit

### Symbol

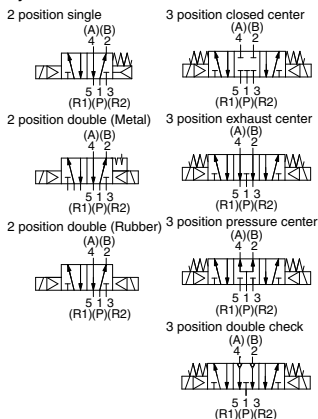

### Standard Specifications

Valve specifications	Valve construction	Metal seal	Rubber seal
	Fluid	Air	
Maximum operating pressure <sup>(3)</sup>	1.0 MPa (0.7 MPa)		
Min. operating pressure	Single	0.15 MPa	0.20 MPa
	Double	0.15 MPa	0.15 MPa
	3 position	0.15 MPa	0.20 MPa
Ambient and fluid temperature	-10 to 50°C <sup>(1)</sup>	-5 to 50°C <sup>(1)</sup>	
Lubrication	Not required		
Manual override	Push type/Locking type (Tool required) Option		
Impact/Vibration resistance	150/30 m/s <sup>2</sup>		
Enclosure	Dust tight (IP65 compatible)		
Coil rated voltage	12, 24 VDC, 100, 110, 200, 220 VAC (50/60 Hz)		
Allowable voltage fluctuation	±10% of rated voltage		
Coil insulation type	Class B or equivalent		
Solenoid specifications	24 VDC	1 W DC (42 mA), 0.5 W DC (21 mA)	
	12 VDC	1 W DC (83 mA), 0.5 W DC (42 mA)	
	100 VAC	Inrush 1.2 VA (12 mA), Holding 1.2 VA (12 mA)	
	110 VAC	Inrush 1.3 VA (11.7 mA), Holding 1.3 VA (11.7 mA)	
	200 VAC	Inrush 2.4 VA (12 mA), Holding 2.4 VA (12 mA)	
220 VAC	Inrush 2.6 VA (11.7 mA), Holding 2.6 VA (11.7 mA)		

Note 1) Use dry air to prevent condensation when operating at low temperatures.

Note 2) Impact resistance: No malfunction occurred when it is tested with a drop tester in the axial direction and at the right angles to the main valve and armature in both energized and de-energized states every once for each condition. (Values at the initial period)

Vibration resistance: No malfunction occurred in a one-sweep test between 45 and 2000 Hz. Test was performed at both energized and de-energized states in the axial direction and at the right angles to the main valve and armature. (Values at the initial period)

Note 3) Values inside ( ) denote the low wattage (0.5 W) specifications.



# Series VQ4000

## Plug-in Type

### Conduit terminal

#### 2 position single: VQ410<sup>0</sup>-□

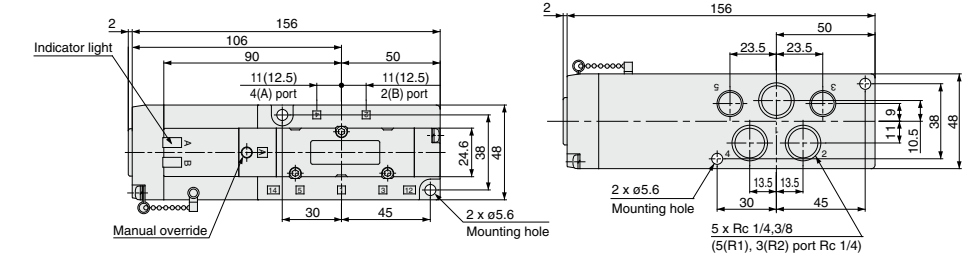

**Bottom ported drawing**

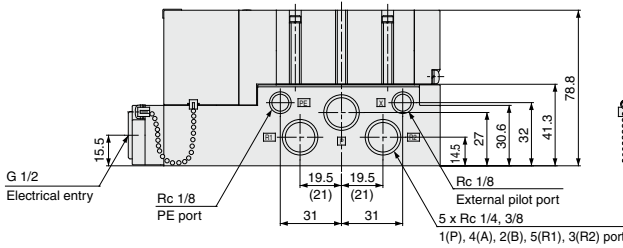

( ): Rc 3/8

- 2 position double: VQ420<sup>0</sup>-□
- 3 position closed center: VQ430<sup>0</sup>-□
- 3 position exhaust center: VQ440<sup>0</sup>-□
- 3 position pressure center: VQ450<sup>0</sup>-□

#### 3 position double check: VQ460<sup>0</sup>-□

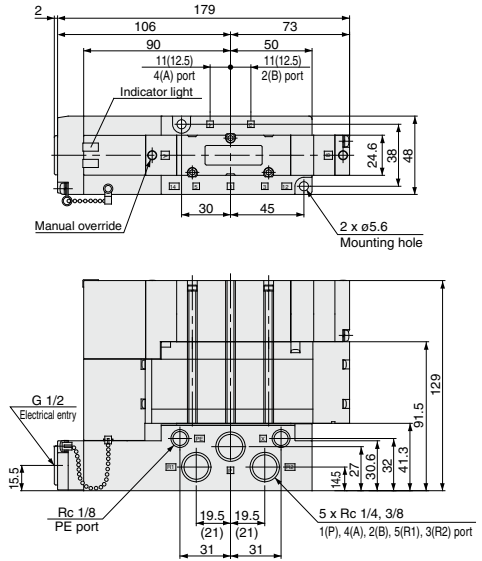
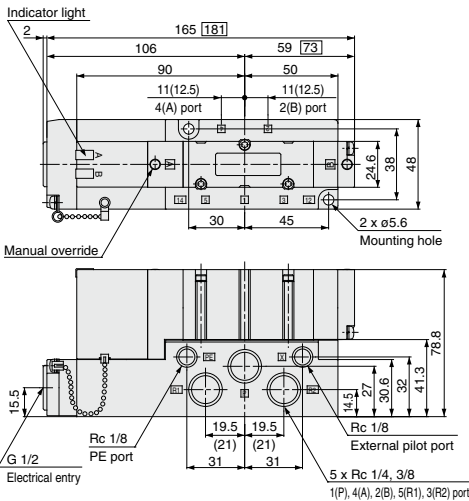

□ : 3 position  
( ): Rc 3/8

**Plug Lead Type**

**Grommet**

**2 position single: VQ415**  $\frac{0}{1}$ -□  $\frac{G}{H}$

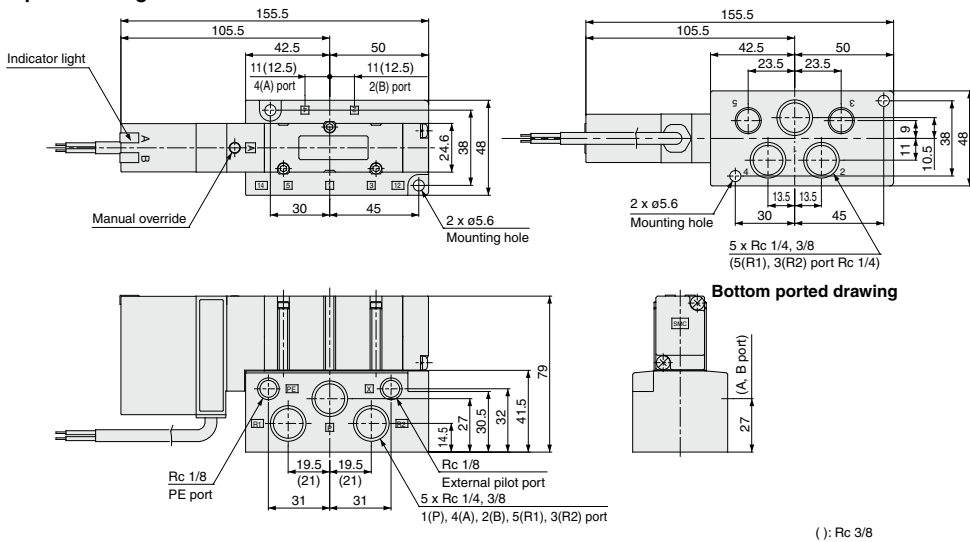

**2 position double: VQ425**  $\frac{0}{1}$ -□  $\frac{G}{H}$

**3 position closed center: VQ435**  $\frac{0}{1}$ -□  $\frac{G}{H}$

**3 position exhaust center: VQ445**  $\frac{0}{1}$ -□  $\frac{G}{H}$

**3 position pressure center: VQ455**  $\frac{0}{1}$ -□  $\frac{G}{H}$

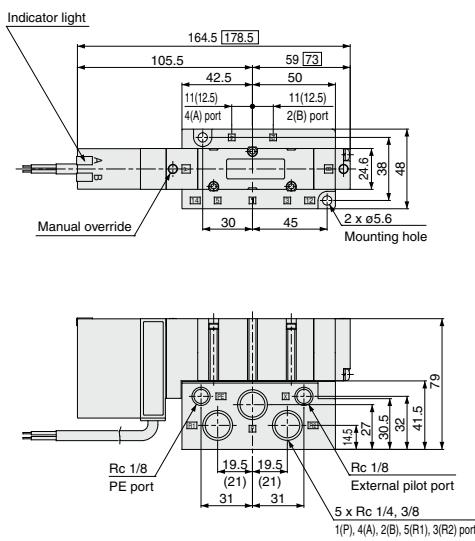

**3 position double check: VQ465**  $\frac{0}{1}$

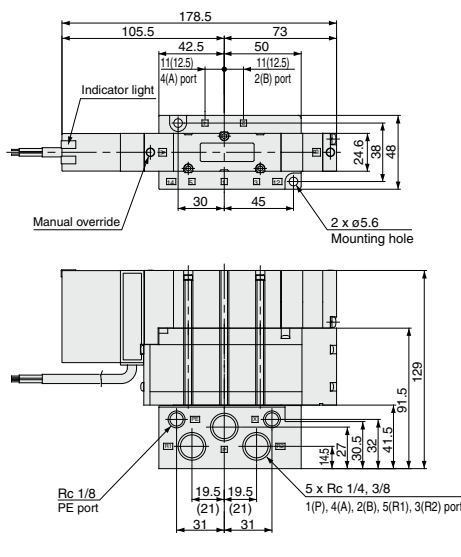

□ : 3 position  
( ): Rc 3/8

SJ
SY
SY
SV
SYJ
SZ
VF
VP4
S0700
VQ
<b>VQ4</b>
VQ5
VQC
VQC4
VQZ
SQ
VFS
VFR
VQ7

# Base Mounted Plug-in Unit

# Series VQ4000



## How to Order Manifold

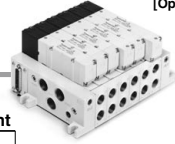
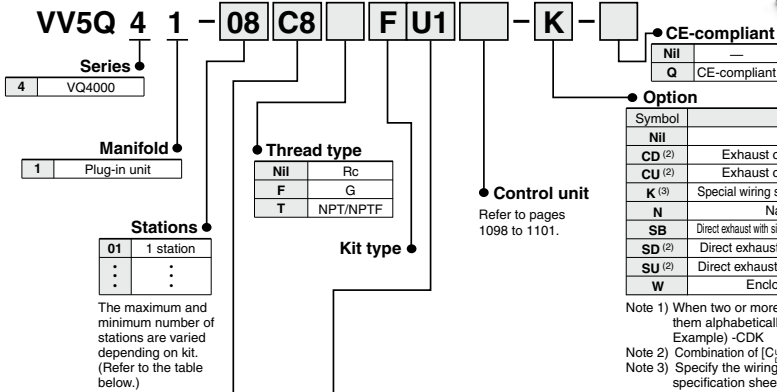

Symbol	Option
Nil	None
CD <sup>(2)</sup>	Exhaust cleaner: For D side mounting
CU <sup>(2)</sup>	Exhaust cleaner: For U side mounting
K <sup>(3)</sup>	Special wiring specifications (Except double wiring)
N	Name plate (T kit only)
SB	Direct exhaust with silencer box: Exhaust from both sides (F/L kits only)
SD <sup>(2)</sup>	Direct exhaust with silencer box: D side exhaust
SU <sup>(2)</sup>	Direct exhaust with silencer box: U side exhaust
W	Enclosure IP65 (Except F kit)

Note 1) When two or more symbols are specified, indicate them alphabetically.  
Example) -CDK

Note 2) Combination of [C<sub>D</sub>] and [S<sub>U</sub>] is not possible.

Note 3) Specify the wiring specifications on the manifold specification sheet. (Except L kit)

**Cylinder port**

C6	With One-touch fitting for ø6
C8	With One-touch fitting for ø8
C10	With One-touch fitting for ø10
C12	With One-touch fitting for ø12
02	Rc 1/4
03	Rc 3/8
B	Bottom ported Rc 1/4
CM	Mixed

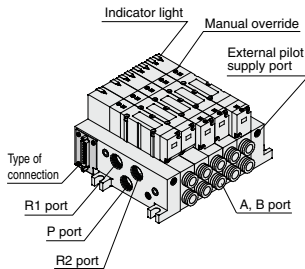

Note) Shown VV5Q41-05C12FD0

### Kit/Electrical entry/Cable length

F kit (D-sub connector)		T kit (Terminal block box kit)																																									
<table border="1"> <thead> <tr> <th colspan="2">Connector entry direction</th> <th></th> <th></th> </tr> <tr> <th>D side</th> <th>U side</th> <th></th> <th></th> </tr> </thead> <tbody> <tr> <td>Kit D0</td> <td>Kit U0</td> <td>Without cable</td> <td>Terminal block mounting position</td> </tr> <tr> <td>Kit D1</td> <td>Kit U1</td> <td>Cable length 1.5 m</td> <td>D side   U side</td> </tr> <tr> <td>Kit D2</td> <td>Kit U2</td> <td>Cable length 3 m</td> <td>18 stations</td> </tr> <tr> <td>Kit D3</td> <td>Kit U3</td> <td>Cable length 5 m</td> <td>3 to 18 stations (Note)</td> </tr> </tbody> </table>		Connector entry direction				D side	U side			Kit D0	Kit U0	Without cable	Terminal block mounting position	Kit D1	Kit U1	Cable length 1.5 m	D side   U side	Kit D2	Kit U2	Cable length 3 m	18 stations	Kit D3	Kit U3	Cable length 5 m	3 to 18 stations (Note)	<table border="1"> <thead> <tr> <th>D side</th> <th>U side</th> <th>Terminal block box</th> <th>3 to 18 stations (Note)</th> </tr> </thead> <tbody> <tr> <td>TD</td> <td>TO</td> <td></td> <td></td> </tr> </tbody> </table>		D side	U side	Terminal block box	3 to 18 stations (Note)	TD	TO										
Connector entry direction																																											
D side	U side																																										
Kit D0	Kit U0	Without cable	Terminal block mounting position																																								
Kit D1	Kit U1	Cable length 1.5 m	D side   U side																																								
Kit D2	Kit U2	Cable length 3 m	18 stations																																								
Kit D3	Kit U3	Cable length 5 m	3 to 18 stations (Note)																																								
D side	U side	Terminal block box	3 to 18 stations (Note)																																								
TD	TO																																										
<p><b>L kit (Lead wire cable)</b></p> <table border="1"> <thead> <tr> <th colspan="2">Electrical entry</th> <th></th> <th></th> </tr> <tr> <th>D side</th> <th>U side</th> <th></th> <th></th> </tr> </thead> <tbody> <tr> <td>Kit L D0</td> <td>Kit L U0</td> <td>Cable length 0.6 m</td> <td rowspan="3">1 to 16 stations</td> </tr> <tr> <td>Kit L D1</td> <td>Kit L U1</td> <td>Cable length 1.5 m</td> </tr> <tr> <td>Kit L D2</td> <td>Kit L U2</td> <td>Cable length 3 m</td> </tr> </tbody> </table>		Electrical entry				D side	U side			Kit L D0	Kit L U0	Cable length 0.6 m	1 to 16 stations	Kit L D1	Kit L U1	Cable length 1.5 m	Kit L D2	Kit L U2	Cable length 3 m	<p><b>S kit (Serial transmission unit)</b></p> <p>The valve is equipped with a lamp/surge suppressor, and the voltage is 24 VDC.</p> <p>IP65 compatible * Applicable to INPUT and OUTPUT type.</p> <table border="1"> <thead> <tr> <th>Unit mounting position</th> <th>CE-compliant</th> </tr> <tr> <th>D side   U side</th> <th></th> </tr> </thead> <tbody> <tr> <td>0 Without SI unit</td> <td>●</td> </tr> <tr> <td>F1 NKE Corp.: Fieldbus System</td> <td>—</td> </tr> <tr> <td>H NKE Corp.: Fieldbus H System</td> <td>—</td> </tr> <tr> <td>J1 Panasonic Industrial Devices S-LINK Co., Ltd.: S-LINK (16 output points)</td> <td>—</td> </tr> <tr> <td>J2 Panasonic Industrial Devices S-LINK Co., Ltd.: S-LINK (8 output points)</td> <td>—</td> </tr> <tr> <td>Q DeviceNet</td> <td>●</td> </tr> <tr> <td>R1 OMRON Corp.: CompoBus/S System (16 output points)</td> <td>●</td> </tr> <tr> <td>R2 OMRON Corp.: CompoBus/S System (8 output points)</td> <td>●</td> </tr> <tr> <td>V CC-Link</td> <td>●</td> </tr> </tbody> </table>		Unit mounting position	CE-compliant	D side   U side		0 Without SI unit	●	F1 NKE Corp.: Fieldbus System	—	H NKE Corp.: Fieldbus H System	—	J1 Panasonic Industrial Devices S-LINK Co., Ltd.: S-LINK (16 output points)	—	J2 Panasonic Industrial Devices S-LINK Co., Ltd.: S-LINK (8 output points)	—	Q DeviceNet	●	R1 OMRON Corp.: CompoBus/S System (16 output points)	●	R2 OMRON Corp.: CompoBus/S System (8 output points)	●	V CC-Link	●
Electrical entry																																											
D side	U side																																										
Kit L D0	Kit L U0	Cable length 0.6 m	1 to 16 stations																																								
Kit L D1	Kit L U1	Cable length 1.5 m																																									
Kit L D2	Kit L U2	Cable length 3 m																																									
Unit mounting position	CE-compliant																																										
D side   U side																																											
0 Without SI unit	●																																										
F1 NKE Corp.: Fieldbus System	—																																										
H NKE Corp.: Fieldbus H System	—																																										
J1 Panasonic Industrial Devices S-LINK Co., Ltd.: S-LINK (16 output points)	—																																										
J2 Panasonic Industrial Devices S-LINK Co., Ltd.: S-LINK (8 output points)	—																																										
Q DeviceNet	●																																										
R1 OMRON Corp.: CompoBus/S System (16 output points)	●																																										
R2 OMRON Corp.: CompoBus/S System (8 output points)	●																																										
V CC-Link	●																																										

Note1) For the T kit and S kit, 2 stations are required to mount the terminal block box or SI unit, so the minimum number of stations is 3 stations.

Note2) Refer to "SI Unit Part No." on page 1084 when ordering the CE-compliant SI unit.

Simple specials are available with SMC Simple Special System. For details, refer to the SMC's website.

## Manifold Specifications

Series	Base model	Type of connection	Porting specifications			Maximum applicable stations	Applicable solenoid valve	Weight (kg) (Formula)
			4(A), 2(B) port location	Port size <small>Note</small>				
				1(P), 5(R1), 3(R2)	4(A), 2(B)			
VQ4000	VV5Q41-□□□	<ul style="list-style-type: none"> <li>■ F kit—D-sub connector</li> <li>■ T kit—Terminal block box</li> <li>■ L kit—Lead wire</li> <li>■ S kit—Serial transmission</li> </ul>	Side	Rc 1/2 Option (Direct exhaust with silencer box)	C6 (For ø6) C8 (For ø8) C10 (For ø10) C12 (For ø12)	F, T kit 18 stations  L kit 16 stations  S kit 18 stations	VQ4□00 VQ4□01	F, L kit: 0.32n+0.75  S, T kit: 0.32(n-2)+1.8  * Except solenoid valve weight
			Bottom		Rc 1/4			

Note) For details about inch-size One-touch fittings and other thread standards, refer to page 1097.

n: Stations

## Flow Characteristics at the Number of Manifold Stations (Operated individually)

Model	Passage/Stations		Station 1	Station 5	Station 10	Station 15
2 position metal seal VQ4 <sub>2</sub> 00	1 → 4/2 (P → A/B)	C [dm <sup>3</sup> /(s·bar)]	5.9	5.9	5.9	5.9
		b	0.23	0.23	0.23	0.23
		Cv	1.5	1.5	1.5	1.5
	4/2 → 5/3 (A/B → EA/EB)	C [dm <sup>3</sup> /(s·bar)]	6.2	6.2	6.2	6.2
		b	0.19	0.19	0.19	0.19
		Cv	1.5	1.5	1.5	1.5
2 position rubber seal VQ4 <sub>2</sub> 01	1 → 4/2 (P → A/B)	C [dm <sup>3</sup> /(s·bar)]	6.8	6.8	6.8	6.8
		b	0.31	0.31	0.31	0.31
		Cv	1.8	1.8	1.8	1.8
	4/2 → 5/3 (A/B → EA/EB)	C [dm <sup>3</sup> /(s·bar)]	7.0	7.0	7.0	7.0
		b	0.38	0.38	0.38	0.38
		Cv	1.9	1.9	1.9	1.9

Note) Port size: Rc 3/8

## Manifold Options

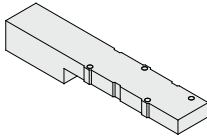
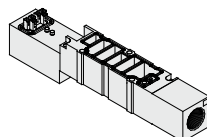
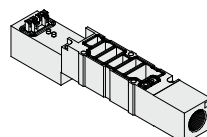
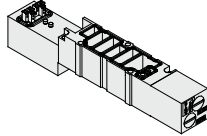
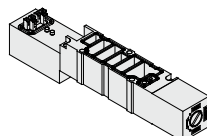
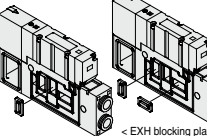
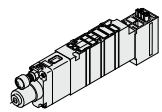
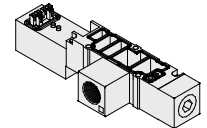
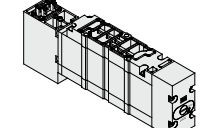
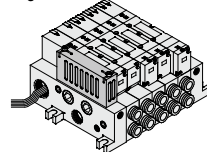
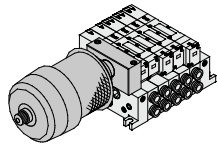
<p><b>Blanking plate assembly</b> VVQ4000-10A-1</p> 	<p><b>Individual SUP spacer</b> VVQ4000-P-1<sub>02 03</sub></p> 	<p><b>Individual EXH spacer</b> VVQ4000-R-1<sub>02 03</sub></p> 	<ul style="list-style-type: none"> <li>• Refer to pages 1092 to 1096 for detailed dimensions of each option.</li> <li>• For replacement parts, refer to page 1108.</li> <li>• Refer to pages 1098 to 1101 for control unit.</li> </ul>
<p><b>Throttle valve spacer</b> VVQ4000-20A-1</p> 	<p><b>SUP stop valve spacer</b> VVQ4000-37A-1</p> 	<p><b>SUP/EXH block plate</b> VVQ4000-16A</p>  <p>&lt; SUP blocking plate &gt; &lt; EXH blocking plate &gt;</p>	<p><b>Interface regulator</b> ARBQ4000-00-<sub>A B</sub>-1<sub>P</sub></p> 
<p><b>Release valve spacer</b> VVQ4000-24A-1D<sup>(1, 2)</sup></p> 	<p><b>Double check spacer with residual pressure exhaust</b> VVQ4000-25A-1<sup>(1)</sup></p> 	<p><b>Direct exhaust with silencer box</b> [-S<sub>0</sub>]<sup>(1)</sup></p> 	<p><b>For exhaust cleaner mounting</b> [-C<sub>0</sub>]<sup>(1)</sup></p> 

Note 1) Release valve spacer and double check spacer for residual pressure exhaust cannot be combined with external pilot.

Note 2) Can be mounted on L kit only. For other kits, order E type control unit.

(Refer to pages 1098 to 1101.)

SJ  
SY  
SY  
SV  
SYJ  
SZ  
VF  
VP4  
S0700  
VQ  
VQ4  
VQ5  
VQC  
VQC4  
VQZ  
SQ  
VFS  
VFR  
VQ7

# Series VQ4000

## F Kit (D-sub connector kit)

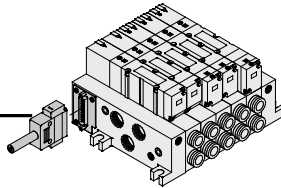

- Simplification and labor savings for wiring work can be achieved by using a D-sub connector for the electrical connection.
- Using connector for flat ribbon cable (25P) conforming to MIL standard permits the use of connectors put on the market and gives a wide interchangeability.
- Connector entry can be selected on either the U side or the D side according to the mounting orientation.
- Maximum stations are 18.

### Manifold Specifications

Series	Porting specifications		Applicable stations
	4(A), 2(B) port location	Port size	
VQ4000	Side	Rc 1/2	Max. 18 stations
	Bottom	Rc 1/4	

### D-Sub Connector Kit (25 pins)

#### Cable assembly ●

015  
AXT100-DS25-030  
050

(D-sub connector cable assemblies can be ordered by with manifolds.)  
Refer to How to Order Manifold.

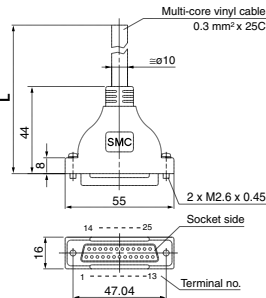

#### D-sub Connector Cable Assembly

Cable length (L)	Assembly part no.	Note
1.5 m	AXT100-DS25-015	Cable 25 cores x 24AWG
3 m	AXT100-DS25-030	
5 m	AXT100-DS25-050	

\* For other commercial connectors, use a 25 pins type with female connector conforming to MIL-C-24308.

\* Cannot be used for transfer wiring.

#### Connector manufacturers' example

- Fujitsu, Ltd.
- Japan Aviation Electronics Industry, Ltd.
- J.S.T. Mfg. Co., Ltd.
- Hirose Electric Co., Ltd.

#### Electric Characteristics

Item	Characteristics
Conductor resistance Ω/km, 20°C	65 or less
Voltage limit VAC, 1 min.	1000
Insulation resistance MΩkm, 20°C	5 or less

Note) The minimum bending radius for D-sub connector cables is 20 mm.

#### D-sub Connector Cable Assembly Terminal No.

Terminal no.	Lead wire color	Dot marking
1	Black	None
2	Brown	None
3	Red	None
4	Orange	None
5	Yellow	None
6	Pink	None
7	Blue	None
8	Purple	White
9	Gray	Black
10	White	Black
11	White	Red
12	Yellow	Red
13	Orange	Red
14	Yellow	Black
15	Pink	Black
16	Blue	White
17	Purple	None
18	Gray	None
19	Orange	Black
20	Red	White
21	Brown	White
22	Pink	Red
23	Gray	Red
24	Black	White
25	White	None

Note) Lengths other than the above are also available. Please contact SMC for details.

### How to Order Manifold

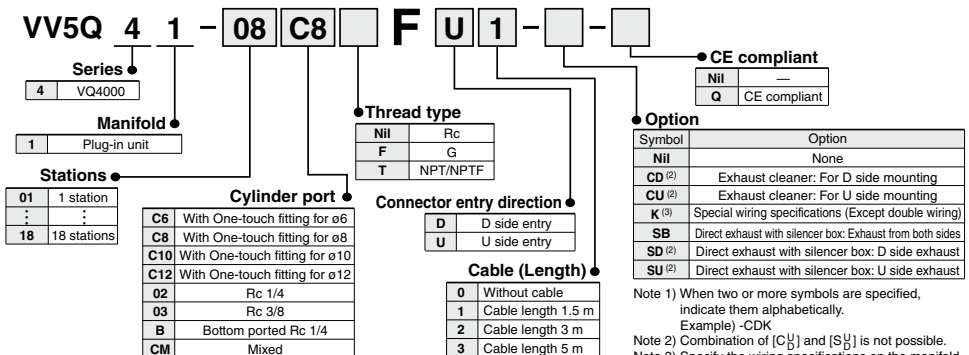

Note) As a semi-standard specification, the maximum number of stations can be increased by special wiring specifications. For details, refer to page 1073.

Note 1) When two or more symbols are specified, indicate them alphabetically.  
Example) -CDK  
Note 2) Combination of [C<sub>1</sub>] and [S<sub>1</sub>] is not possible.  
Note 3) Specify the wiring specifications on the manifold specification sheet.  
Note 4) Refer to pages 1098 to 1101 for with control unit.



## ● Electrical wiring specifications

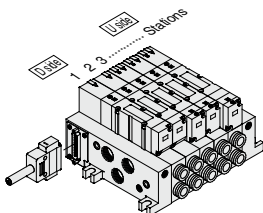

Stations are counted starting from the first station on the D side.

### D-sub connector

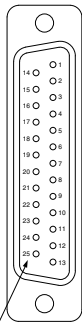

Double wiring (connected to SOL. A and SOL. B) is adopted for the internal wiring of each station, regardless of valve and option types. Mixed single and double wiring is available as a semi-standard specification. For details, refer to below.

(Note) There is no polarity. It can also be used as a negative common.

### Standard wiring

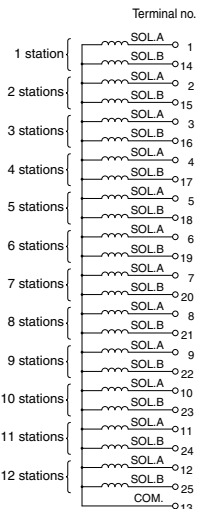

### Wiring with control unit

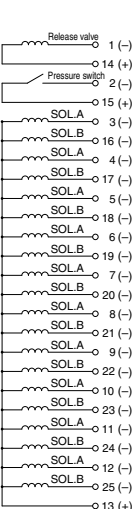

### D-sub connector assembly AXT100-DS25-030 015 050

Polarity	Lead wire color	Dot marking
(+)	Black	None
(-)	Yellow	None
(+)	Brown	None
(-)	Pink	Black
(+)	Red	None
(+)	Blue	White
(+)	Orange	None
(+)	Purple	None
(+)	Yellow	None
(+)	Gray	None
(+)	Pink	None
(+)	Orange	Black
(+)	Blue	None
(+)	Red	White
(+)	Brown	White
(+)	Gray	Black
(+)	Pink	Red
(+)	White	Black
(+)	Gray	Red
(+)	White	Red
(+)	Black	White
(+)	Yellow	Red
(+)	White	None
(-) <sup>(Note)</sup>	Orange	Red

Positive common specifications Negative common specifications

## Special Wiring Specifications

Double wiring (connected to SOL. A and SOL. B) is used for the internal wiring of each station regardless of valve and option types. Mixed single and double wiring is available as a semi-standard specification.

### 1. How to order

Indicate option symbol "K" in the manifold part number and be sure to specify station positions for single or double wiring on the manifold specification sheet.

### 2. Wiring specifications

Connections begin with the A side solenoid of the first station being connected to terminal no. 1, and continue in the order indicated by the arrows in the drawing without skipping any terminals. Maximum stations are 18.

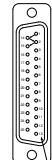

D-sub connector



[Option]

## How to Order Valves

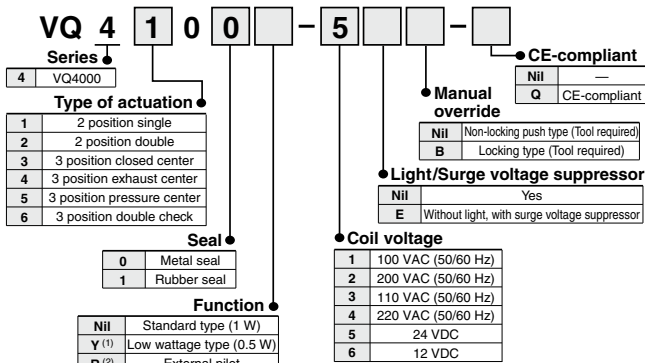

## How to Order Manifold Assembly

Specify the part numbers for valves and options together beneath the manifold base part number.

### <Example>

D-sub connector kit with cable (3 m)  
 V5VQ41-05CFD2(-Q)-1 set —Manifold base part no.  
 \*VQ4100-5(-Q).....2 sets —Valve part no. (Stations 1 and 2)  
 \*VQ4200-5(-Q).....2 sets —Valve part no. (Stations 3 and 4)  
 \*VQ4300-5(-Q).....1 set —Valve part no. (Station 5)

Prefix the asterisk to the part nos. of the solenoid valve, etc.

Enter in order starting from the first station on the D side. When entry of part numbers becomes complicated, indicate in the manifold specification sheet.

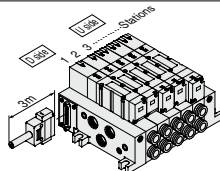

Note 1) Applicable to DC specifications. Please select when you expect to energize the unit for extended periods of time. Refer to page 3 for details.  
 Note 2) Refer to page 1079 for external pilot specification. Combination of external pilot and perfect interface is not possible.  
 Note 3) When two or more symbols are specified, indicate them alphabetically.

- SJ
- SY
- SY
- SV
- SYJ
- SZ
- VF
- VP4
- S0700
- VQ
- VQ4
- VQ5
- VQC
- VQC4
- VQZ
- SQ
- VFS
- VFR
- VQ7

# Series VQ4000

## F Kit (D-sub connector kit)

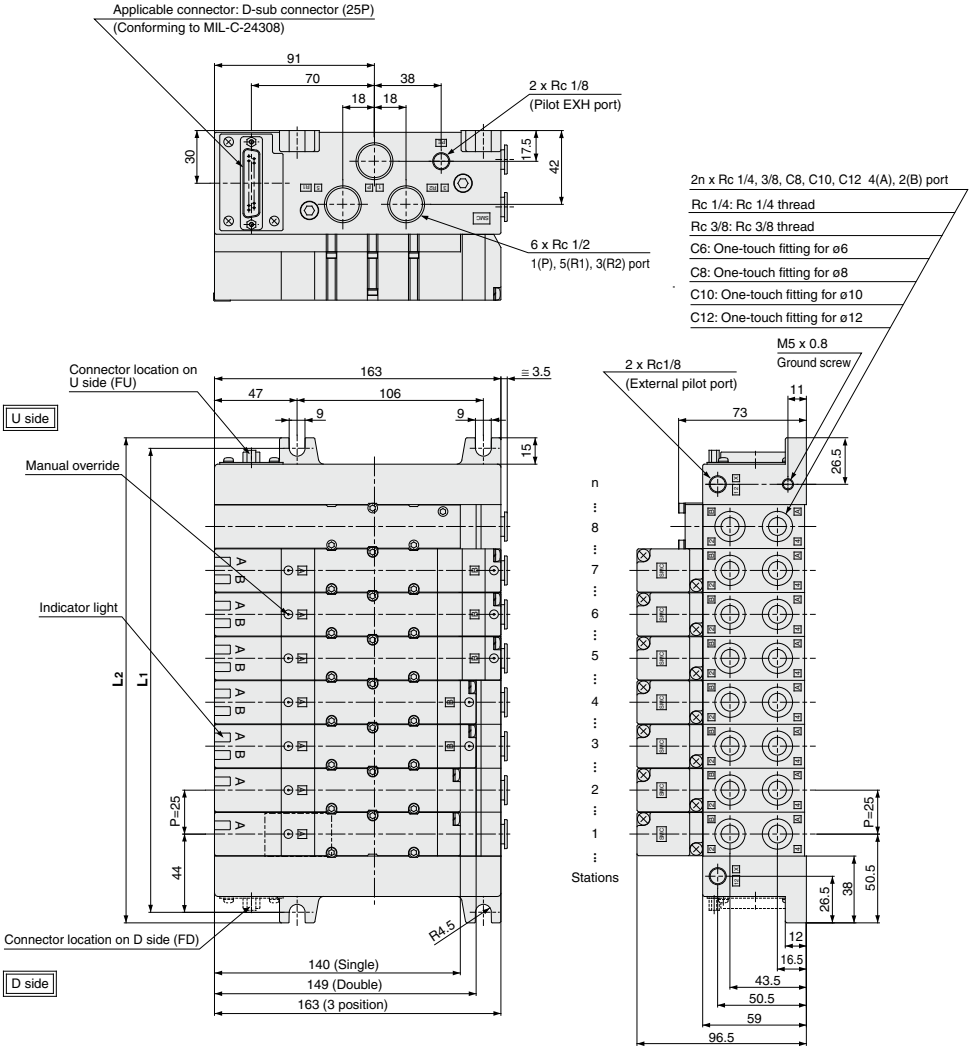

**Bottom ported drawing**

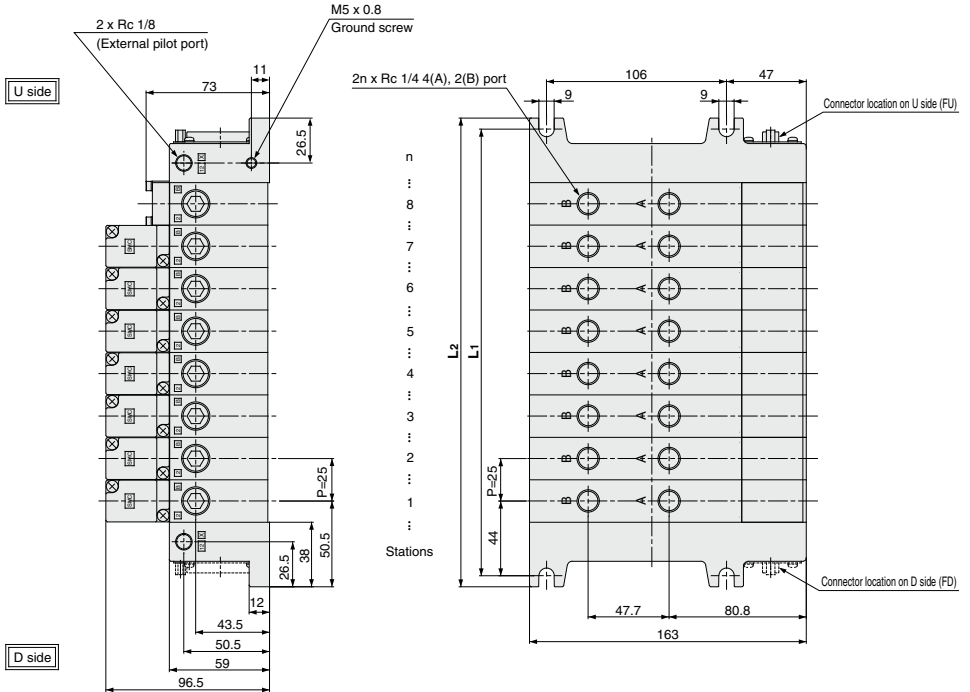

- SJ
- SY
- SY
- SV
- SYJ
- SZ
- VF
- VP4
- S0700
- VQ
- VQ4**
- VQ5
- VQC
- VQC4
- VQZ
- SQ
- VFS
- VFR
- VQ7

**Dimensions**

Formula  $L1 = 25n + 63$ ,  $L2 = 25n + 76$

n: Station (Maximum standard 18 stations)

L	n	1	2	3	4	5	6	7	8	9	10	11	12	13	14	15	16	17	18
L1		88	113	138	163	188	213	238	263	288	313	338	363	388	413	438	463	488	513
L2		101	126	151	176	201	226	251	276	301	326	351	376	401	426	451	476	501	526

# Series VQ4000

## T Kit (Terminal block box kit)

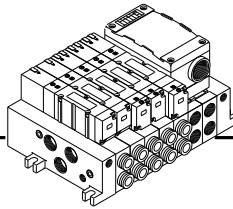

IP65 compliant

- Enclosure IP65 compliant
- This type has a small terminal block inside a junction box.  
The provision of a G 3/4 electrical entry allows connection of conduit fittings.
- Maximum stations are 18.
- 2 stations are used for terminal box mounting.

### Manifold Specifications

Series	Porting specifications			Applicable stations
	4(A), 2(B) port location	Port size		
		1(P), 5(R1), 3(R2)	4(A), 2(B)	
VQ4000	Side	Rc 1/2	C8, 10, 12 Rc 1/4, 3/8	Max. 18 stations
	Bottom		Rc 1/4	

## Terminal Block Connections

### Step 1. How to remove terminal block cover

Loosen the 4 mounting screws (M4) and open the terminal block cover.

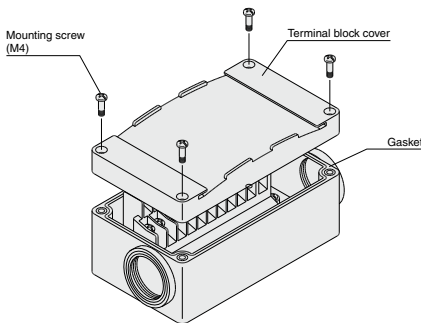

### Step 2. The diagram on the right shows the terminal block wiring. All stations are provided with double wiring regardless of the valves which are mounted.

Connect each wire to the power supply side, according to the markings provided inside the terminal block.

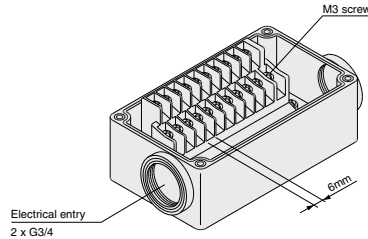

### Step 3. How to attach the terminal block cover

Securely tighten the screws with the torque shown in the table below, after confirming that the gasket is installed correctly.

Proper tightening torque (N·m)
0.7 to 1.2

- Applicable terminal 1.25-3S, 1.25Y-3, 1.25Y-3N, 1.25Y-3.5
- Name plate: VVQ5000-N-T
- Drip proof plug assembly (for G 3/4): AXT100-B06A

## How to Order Manifold

**Series** 4 VQ4000

**Manifold** 1 Plug-in unit

**Stations**

03	3 stations
:	:
18	18 stations

Note) 2 stations are used for mounting the terminal block box. The number of stations is the number of manifold valves plus 2 stations for the terminal block box. For 13 stations or more, specify the wiring specifications by means of the manifold specification sheet.

**Cylinder port**

C6	With One-touch fitting for ø6
C8	With One-touch fitting for ø8
C10	With One-touch fitting for ø10
C12	With One-touch fitting for ø12
O2	Rc 1/4
O3	Rc 3/8
B	Bottom ported Rc 1/4
CM	Mixed

Note) As a semi-standard specification, the maximum number of stations can be increased by special wiring specifications. For details, refer to page 1077.

**Thread type**

Nil	Rc
F	G
T	NPT/NPTF

**Box mounting position**

O	U side mounting
D	D side mounting

**CE-compliant**

Nil	—
Q	CE-compliant

**Option**

Symbol	Option
Nil	None
CD <sup>(2)</sup>	Exhaust cleaner: For D side mounting
CU <sup>(2)</sup>	Exhaust cleaner: For U side mounting
K <sup>(3)</sup>	Special wiring specifications (except double wiring)
N <sup>(4)</sup>	Name plate
SD <sup>(2)</sup>	Direct exhaust with silencer box: D side exhaust
SU <sup>(2)</sup>	Direct exhaust with silencer box: U side exhaust
W	IP65 enclosure

Note 1) When two or more symbols are specified, indicate them alphabetically.  
Example) -CDK

Note 2) Combination of [CD] and [SD] is not possible.

Note 3) Specify the wiring specifications on the manifold specification sheet.

Note 4) Name plate is inlaid in the terminal block cover.

Note 5) Refer to pages 1098 to 1101 for with control unit.



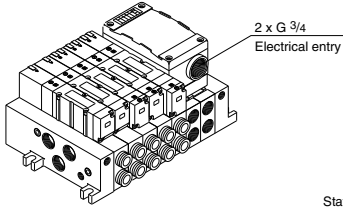

2 x G 3/4  
Electrical entry

Stations are counted starting from the first station on the D side.

## Electrical wiring specifications

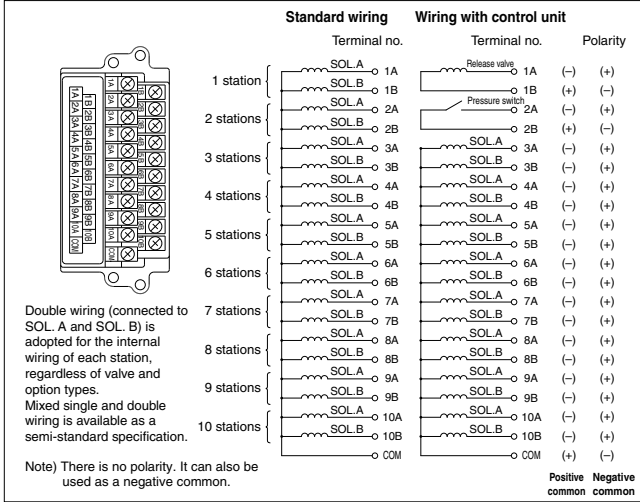

## Special Wiring Specifications

Double wiring (connected to SOL. A and SOL. B) is used for the internal wiring of each station regardless of valve and option types. The optional specification permits mixture of single and double wiring. However, the maximum number of stations is 16.

### 1. How to Order

Indicate option symbol "K" in the manifold part number and be sure to specify station positions for single or double wiring on the manifold specification sheet.

### 2. Wiring specifications

Connections begin with the A side solenoid of the first station being connected to terminal no. 1, and continue in the order indicated by the arrows in the drawing without skipping any terminals.



## How to Order Valves

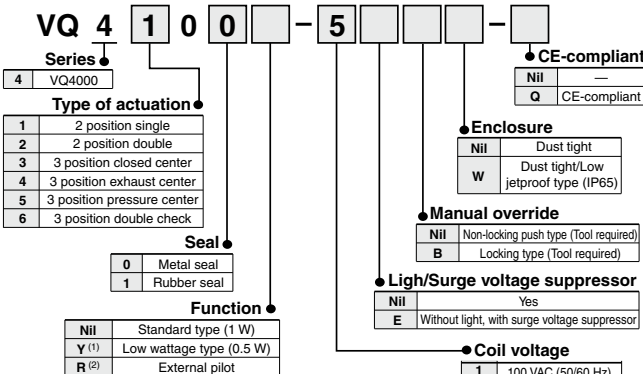

Note 1) Applicable to DC specifications. Please select when you expect to energize the unit for extended periods of time. Refer to page 3 for details.  
 Note 2) Refer to page 1097 for external pilot specification. Combination of external pilot and perfect interface is not possible.  
 Note 3) When two or more symbols are specified, indicate them alphabetically.

## How to Order Manifold Assembly

Specify the part numbers for valves and options together beneath the manifold base part number.

### <Example>

- Terminal block box kit
- VV5Q41-07C8T0(-Q)-1 set—Manifold base part no.
- \*VQ4100-5(-Q).....2 sets—Valve part no. (Stations 1 and 2)
- \*VQ4200-5(-Q).....2 sets—Valve part no. (Stations 3 and 4)
- \*VQ4300-5(-Q).....1 set—Valve part no. (Station 5)

Prefix the asterisk to the part nos. of the solenoid valve, etc.

Enter in order starting from the first station on the D side. When entry of part numbers becomes complicated, indicate in the manifold specification sheet.

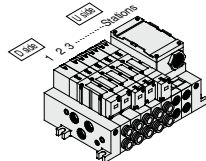

- SJ
- SY
- SY
- SV
- SYJ
- SZ
- VF
- VP4
- S0700
- VQ
- VQ4
- VQ5
- VQC
- VQC4
- VQZ
- SQ
- VFS
- VFR
- VQ7

# Series VQ4000

# T

## Kit (Terminal block box kit)

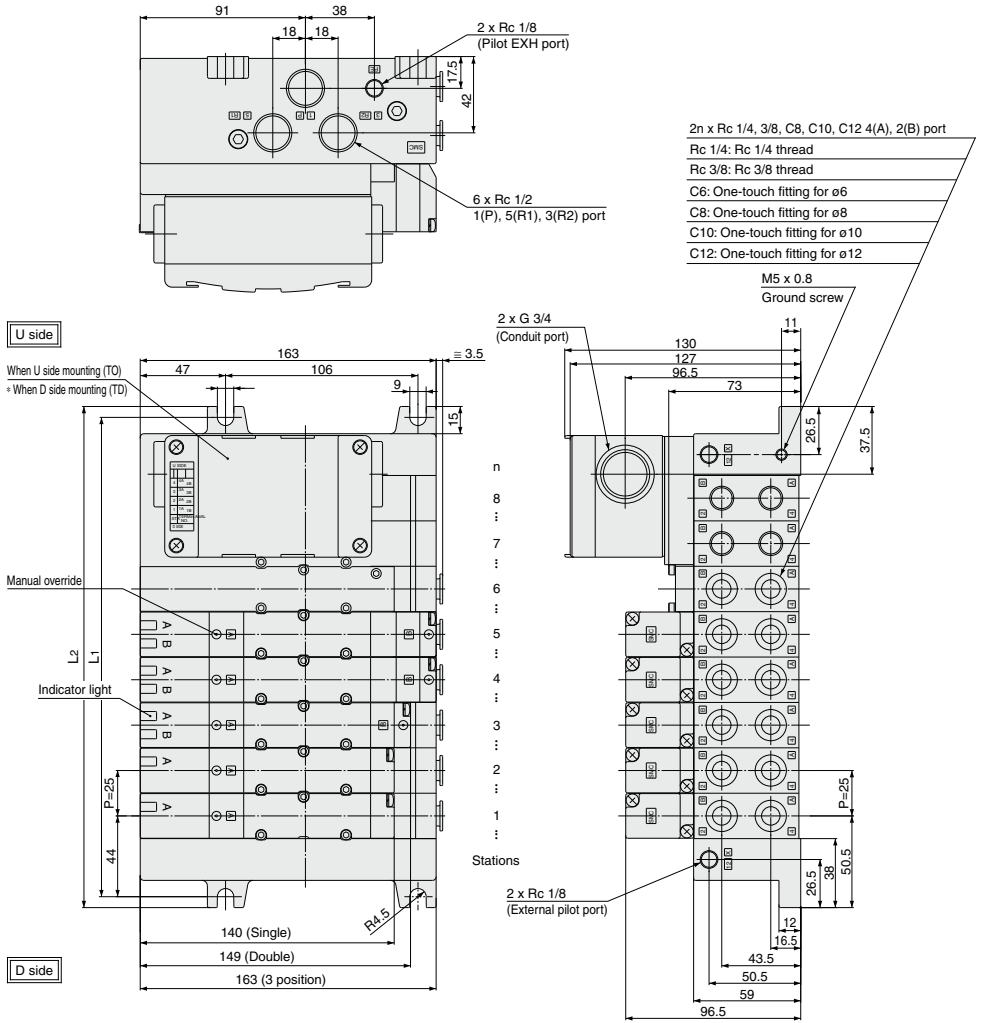

Note) Shown VV5Q41-08C12TO-W

**Bottom ported drawing**

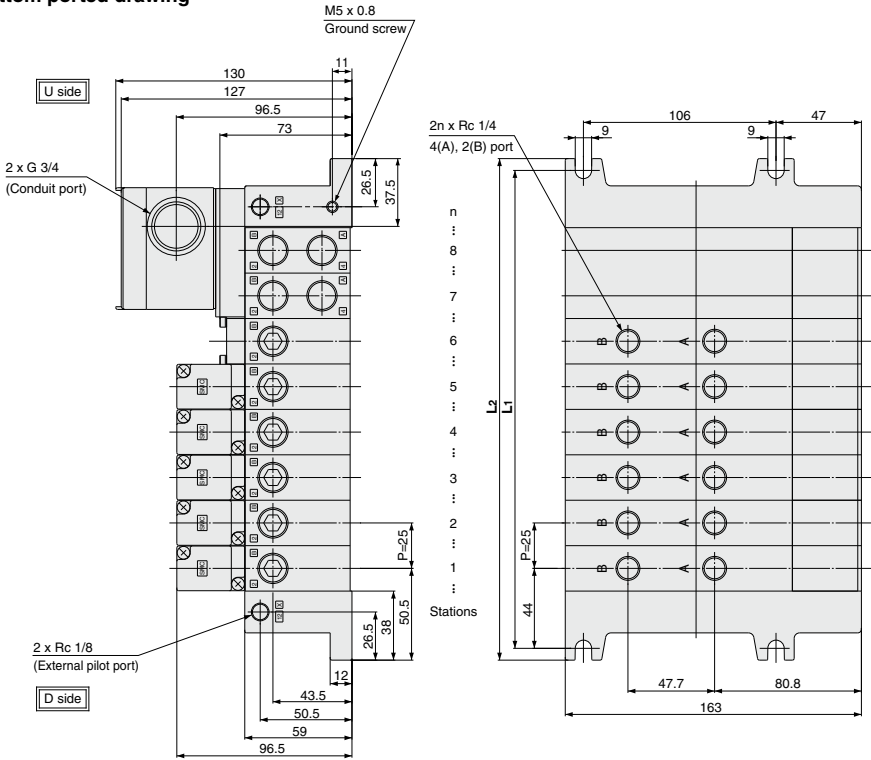

- SJ
- SY
- SY
- SV
- SYJ
- SZ
- VF
- VP4
- S0700
- VQ
- VQ4**
- VQ5
- VQC
- VQC4
- VQZ
- SQ
- VFS
- VFR
- VQ7

Formula  $L1 = 25n + 63$ ,  $L2 = 25n + 76$  n: Station (Maximum standard 18 stations)  
 \* Including 2 stations for terminal box.

**Dimensions**

L	n	3	4	5	6	7	8	9	10	11	12	13	14	15	16	17	18
		L1	138	163	188	213	238	263	288	313	338	363	388	413	438	463	488
L2	151	176	201	226	251	276	301	326	351	376	401	426	451	476	501	526	

# Series VQ4000

**L** Kit (Lead wire cable)

**IP65 compliant**

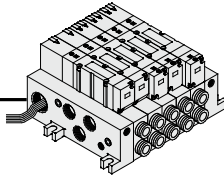

- Enclosure IP65 compliant
- Direct electrical entry. Models with two or more stations are available.
- Electrical entry can be selected on either the U side or the D side according to the mounting orientation.
- Maximum stations are 16.

## Manifold Specifications

Series	Porting specifications		Applicable stations	
	4(A), 2(B) port location	Port size		
VQ4000		Side	Rc 1/2	C 8, 10, 12 Rc 1/4, 3/8
	Bottom	Rc 1/4		

## Wiring Specifications

Three lead wires are attached to each station regardless of the type of valve which is mounted. The red wire is for COM connection.

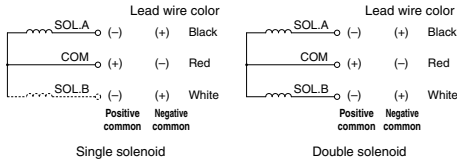

Single solenoid

Double solenoid

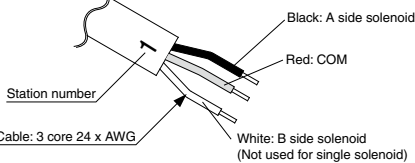

For different lead wire lengths, order a lead wire assembly with connector shown in the table on the right.  
 Note 1) There is no polarity. It can also be used as a negative common.  
 Note 2) Connect the release valve and the pressure switch to SOL. A side on the manifold with control unit.

## Lead Wire Assembly with Connector

Lead wire length	Part no.
0.6 m	VVQ5000-44A-8-□
1.5 m	VVQ5000-44A-15-□
3 m	VVQ5000-44A-30-□

□: Number of stations 1 to 16.

## How to Order Manifold

**CE**  
[Option]

**VV5Q 4 1 - 08 C8** **L** **U** - -

**Series**  
4 VQ4000

**Manifold**  
1 Plug-in unit

**Stations**

01	1 station
⋮	⋮
16	16 stations

**Cylinder port**

C6	With One-touch fitting for ø6
C8	With One-touch fitting for ø8
C10	With One-touch fitting for ø10
C12	With One-touch fitting for ø12
02	Rc 1/4
03	Rc 3/8
B	Bottom ported Rc 1/4
CM	Mixed

**Thread type**

NII	Rc
F	G
T	NPT/NPTF

**CE-compliant**

NII	—
Q	CE-compliant

**Option**

Symbol	Option
NII	None
CD	Exhaust cleaner: For D side mounting
CU	Exhaust cleaner: For U side mounting
SB	Direct exhaust with silencer box: Exhaust from both sides
SD	Direct exhaust with silencer box: D side exhaust
SU	Direct exhaust with silencer box: U side exhaust
W	IP65 enclosure

Note) When two or more symbols are specified, indicate them alphabetically.  
 Example) -CDW

**Cable (Length)**

0	Cable length 0.6 m
1	Cable length 1.5 m
2	Cable length 3 m

**Connector locations**

D	D side entry
U	U side entry



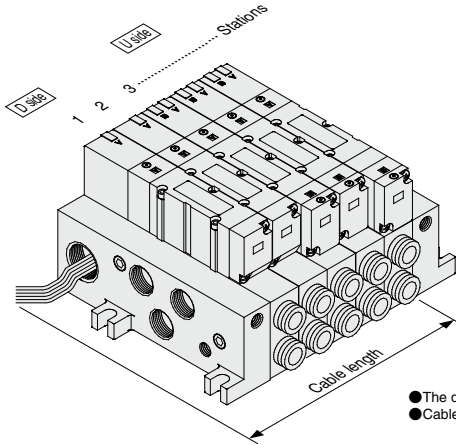

- The drawing shows the electrical entry on the D side.
- Cable length is measured from the solenoid valve body.



## How to Order Manifold Assembly

Specify the part numbers for valves and options together beneath the manifold base part number.

### <Example>

Lead wire kit with cable (3 m)

- VV5Q41-05C8LD2(-Q).... 1 set—Manifold base part no.
- \*VQ4100-5(-Q)..... 2 sets—Valve part no. (Stations 1 and 2)
- \*VQ4200-5(-Q)..... 2 sets—Valve part no. (Stations 3 and 4)
- \*VQ4300-5(-Q).... 1 set—Valve part no. (Station 5)

Prefix the asterisk to the part nos. of the solenoid valve, etc.

Enter in order starting from the first station on the D side. When entry of part numbers becomes complicated, indicate in the manifold specification sheet.

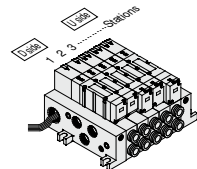

## How to Order Valves

**VQ 4 1 0 0 - 5**

**Series**

4	VQ4000
---	--------

**Type of actuation**

1	2 position single
2	2 position double
3	3 position closed center
4	3 position exhaust center
5	3 position pressure center
6	3 position double check

**Seal**

0	Metal seal
1	Rubber seal

**CE-compliant**

Nil	—
Q	CE-compliant

**Enclosure**

Nil	Dust tight
W	Dust tight/Low jetproof type (IP65)

**Manual override**

Nil	Non-locking push type (Tool required)
B	Locking type (Tool required)

**Light/Surge voltage suppressor**

Nil	Yes
E	Without light, with surge voltage suppressor

**Coil voltage**

1	100 VAC (50/60 Hz)
2	200 VAC (50/60 Hz)
3	110 VAC (50/60 Hz)
4	220 VAC (50/60 Hz)
5	24 VDC
6	12 VDC

**Function**

Nil	Standard type (1 W)
Y <sup>(1)</sup>	Low wattage type (0.5 W)
R <sup>(2)</sup>	External pilot

Note 1) Applicable to DC specification. Please select when you expect to energize the unit for extended periods of time. Refer to page 3 for details.

Note 2) Refer to page 1097 for external pilot specification. Combination of external pilot and perfect interface is not possible.

Note 3) When two or more symbols are specified, indicate them alphabetically.

SJ
SY
SV
SYJ
SZ
VF
VP4
S0700
VQ
VQ4
VQ5
VQC
VQC4
VQZ
SQ
VFS
VFR
VQ7

# Series VQ4000

## Kit (Lead wire cable)

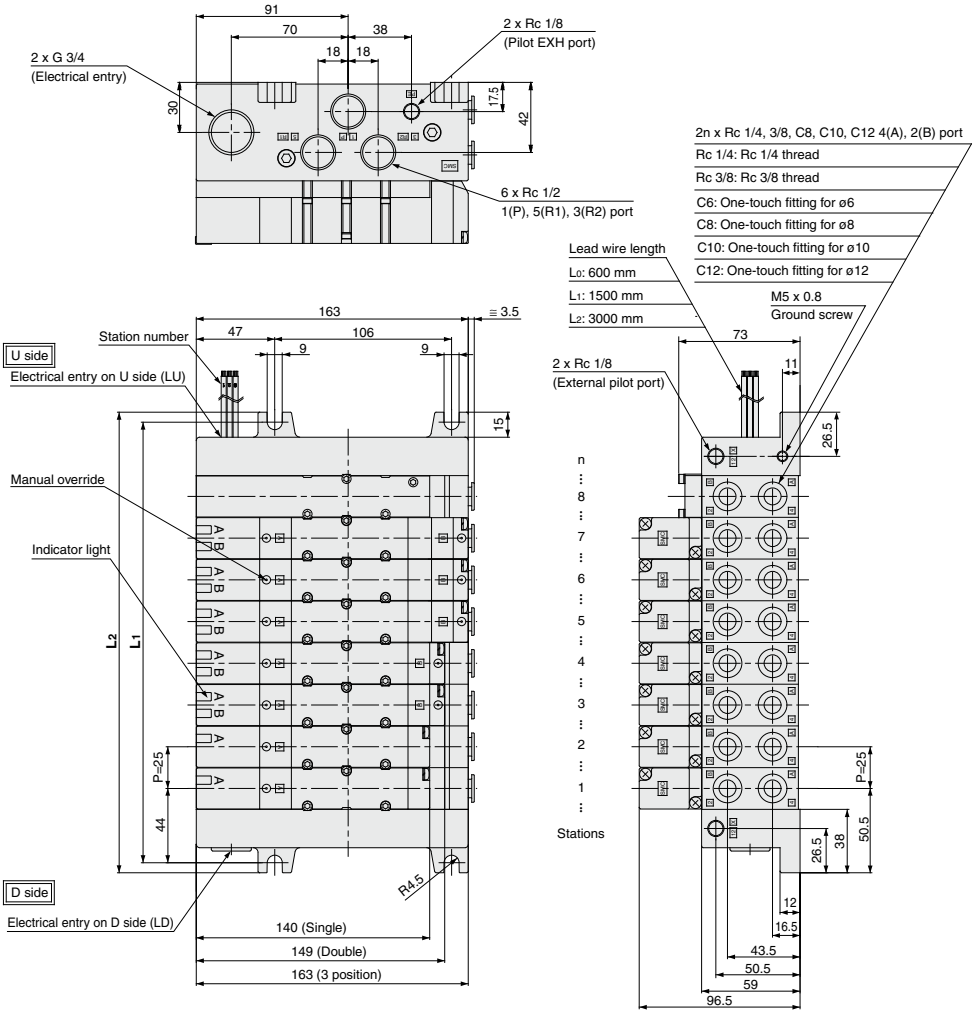

**Bottom ported drawing**

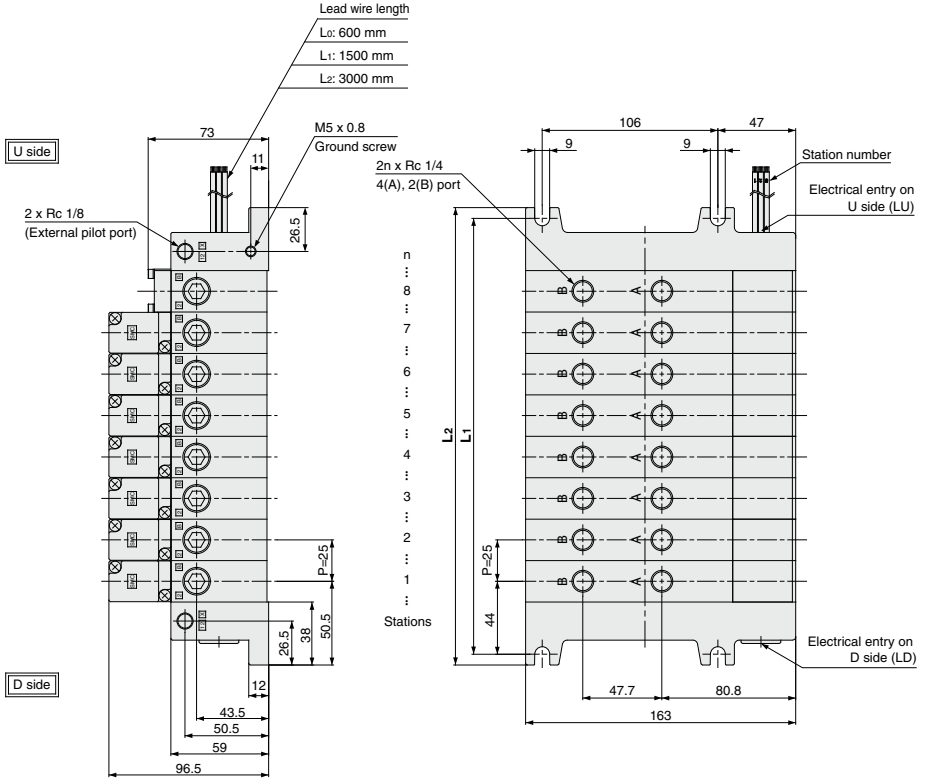

- SJ
- SY
- SY
- SV
- SYJ
- SZ
- VF
- VP4
- S0700
- VQ
- VQ4**
- VQ5
- VQC
- VQC4
- VQZ
- SQ
- VFS
- VFR
- VQ7

**Dimensions**

Formula L1 = 25n + 63, L2 = 25n + 76 n: Station (Maximum 16 stations)

L	n	1	2	3	4	5	6	7	8	9	10	11	12	13	14	15	16
L1		88	113	138	163	188	213	238	263	288	313	338	363	388	413	438	463
L2		101	126	151	176	201	226	251	276	301	326	351	376	401	426	451	476

# Series VQ4000

# S

Kit (Serial transmission unit): EX123/124 (For Output) Serial Transmission System **IP65 compliant**

- The serial transmission system reduces wiring work, while minimizing wiring and saving space.

## Manifold Specifications

Series	Porting specifications		Applicable stations
	4(A), 2(B) port port location	Port size	
VQ4000		Side	1(P), 5(R1), 3(R2)
	Rc 1/2		C8, 10, 12 Rc 1/4, 3/8
	Bottom		Rc 1/4

- Double wiring (connected to SOL. A and SOL. B) is adopted for the internal wiring of each station, regardless of valve and option types.

Item	Specifications
External power supply	24 VDC +10%, -5%
Current consumption (Internal unit)	0.1A

- Drip proof plug assembly (for G 1/2): AXT100-B04A

Note) Refer to "SI Unit Part No." when ordering the CE-compliant SI unit. **[Option]**



## How to Order Manifold

VV5Q 4 1 - 08 C8 S V - -

**Series**  
4 VQ4000

**Manifold**  
1 Plug-in unit

**Stations**

03	3 stations
⋮	⋮
18	18 stations

Note) 2 stations are used for mounting SI unit. The number of stations is the number of manifold valves plus 2 stations for SI unit. For 11 stations or more, specify the wiring specifications by means of the manifold specification sheet.

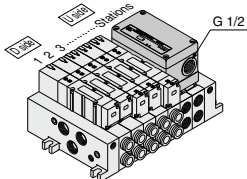

Stations are counted starting from the first station on the D side.

**Cylinder ports**

C6	With One-touch fitting for ø6
C8	With One-touch fitting for ø8
C10	With One-touch fitting for ø10
C12	With One-touch fitting for ø12
02	Rc 1/4
03	Rc 3/8
B	Bottom ported Rc 1/4
CM	Mixed

**Thread type**

NH	Rc
F	G
T	NPT/NPTF

### SI unit mounting position

NH	U side mounting
D	D side mounting

### CE-compliant

NH	—
Q	CE-compliant

Note) Refer to "SI Unit Part No." when ordering the CE-compliant SI unit.

### Option

Symbol	Option
NH	None
CD <sup>(2)</sup>	Exhaust cleaner: D side mounting
CU <sup>(2)</sup>	Exhaust cleaner for Rc 1: U side exhaust
K <sup>(3)</sup>	Special wiring specifications (Except double wiring)
SD <sup>(2)</sup>	Direct exhaust with silencer box: D side exhaust
SU <sup>(2)</sup>	Direct exhaust with silencer box: U side exhaust
W <sup>(2)</sup>	IP65 enclosure

Note 1) When two or more symbols are specified, indicate them alphabetically.

Example) -CDK

Note 2) Combination of [CD] and [SD] is not possible.

Note 3) Specify the wiring specifications in the manifold specification sheet.

Note 4) Refer to pages 1098 to 1101 for with control unit consumption of AC type.

Note 5) The release valve and the pressure switch on the manifold with control unit are connected to another power supply. Cable length is 0.6 m for L kit.

### SI unit

Symbol	Without SI unit
0	Without SI unit
F1	NKE Corp.: Fieldbus System
H	NKE Corp.: Fieldbus H System
J1	Panasonic Industrial Devices SUNX Co., Ltd.: S-LINK (16 output points)
J2	Panasonic Industrial Devices SUNX Co., Ltd.: S-LINK (8 output points)
Q	DeviceNet
R1	OMRON Corp.: CompoBus/S System (16 output points)
R2	OMRON Corp.: CompoBus/S System (8 output points)
V	CC-Link

### SI Unit Part No.

Symbol	Protocol type	SI unit part no.	CE compliant	Page
F1	NKE Corp.: Fieldbus System	D side: EX123D-SUW1 U side: EX123U-SUW1	—	P.1165
H	NKE Corp.: Fieldbus H System	D side: EX123D-SUH1 U side: EX123U-SUH1	—	
J1	Panasonic Industrial Devices SUNX Co., Ltd.: S-LINK (16 output points)	D side: EX123D-SSL1 U side: EX123U-SSL1	—	
J2	Panasonic Industrial Devices SUNX Co., Ltd.: S-LINK (8 output points)	D side: EX123D-SSL2 U side: EX123U-SSL2	—	
Q	DeviceNet	D side: EX124D-SDN1 U side: EX124U-SDN1	●	
R1	OMRON Corp.: CompoBus/S System (16 output points)	D side: EX124D-SCS1 U side: EX124U-SCS1	●	
R2	OMRON Corp.: CompoBus/S System (8 output points)	D side: EX124D-SCS2 U side: EX124U-SCS2	●	
V	CC-Link	D side: EX124D-SMJ1 U side: EX124U-SMJ1	●	

Refer to page 2055 and the Operation Manual for the details of EX123/124 Integrated-type (For Output) Serial Transmission System. Please download the Operation Manual via our website, <http://www.smcworld.com>



**How to Order Valves**

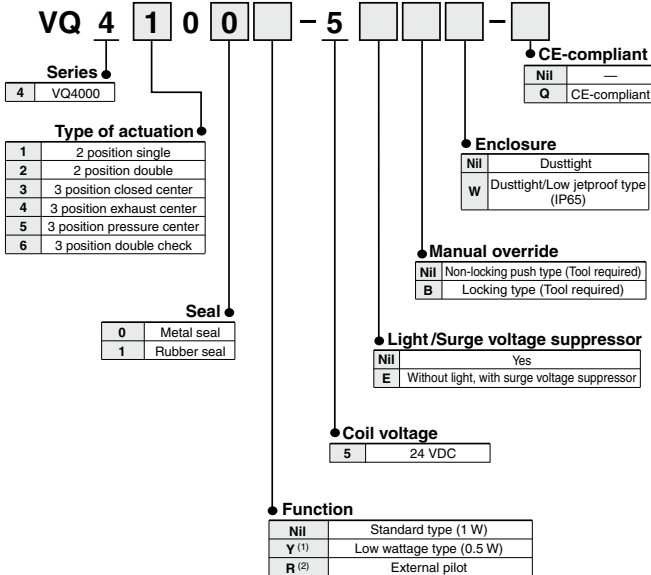

- Note 1) Applicable to DC specifications. Please select when you expect to energize the unit for extended periods of time. Refer to page 3 for details.
- Note 2) For external pilot specifications, refer to page 1097. Combination of the external pilot and perfect interface is not possible.
- Note 3) When two or more symbols are specified, indicate them alphabetically.

**How to Order Manifold Assembly [Order example]**

Specify the part numbers for valves and options together beneath the manifold base part number.

<Example>

VV5Q41-07C8SV(Q) ...1 set—Manifold base part no.  
 \*VQ4100-5(Q).....2 sets—Valve part no. (Stations 1 and 2)  
 \*VQ4200-5(Q).....2 sets—Valve part no. (Stations 3 and 4)  
 \*VQ4300-5(Q).....1 set—Valve part no. (Station 5)

Prefix the asterisk to the part nos. of the solenoid valve, etc.

Enter in order starting from the first station on the D side.  
 When entry of part numbers becomes complicated, indicate in the manifold specification sheet.

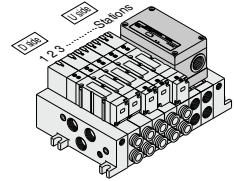

- SJ
- SY
- SY
- SV
- SYJ
- SZ
- VF
- VP4
- S0700
- VQ
- VQ4**
- VQ5
- VQC
- VQC4
- VQZ
- SQ
- VFS
- VFR
- VQ7

# Series VQ4000

# S

## Kit (Serial transmission unit): EX123/124 (For Output) Serial Transmission System

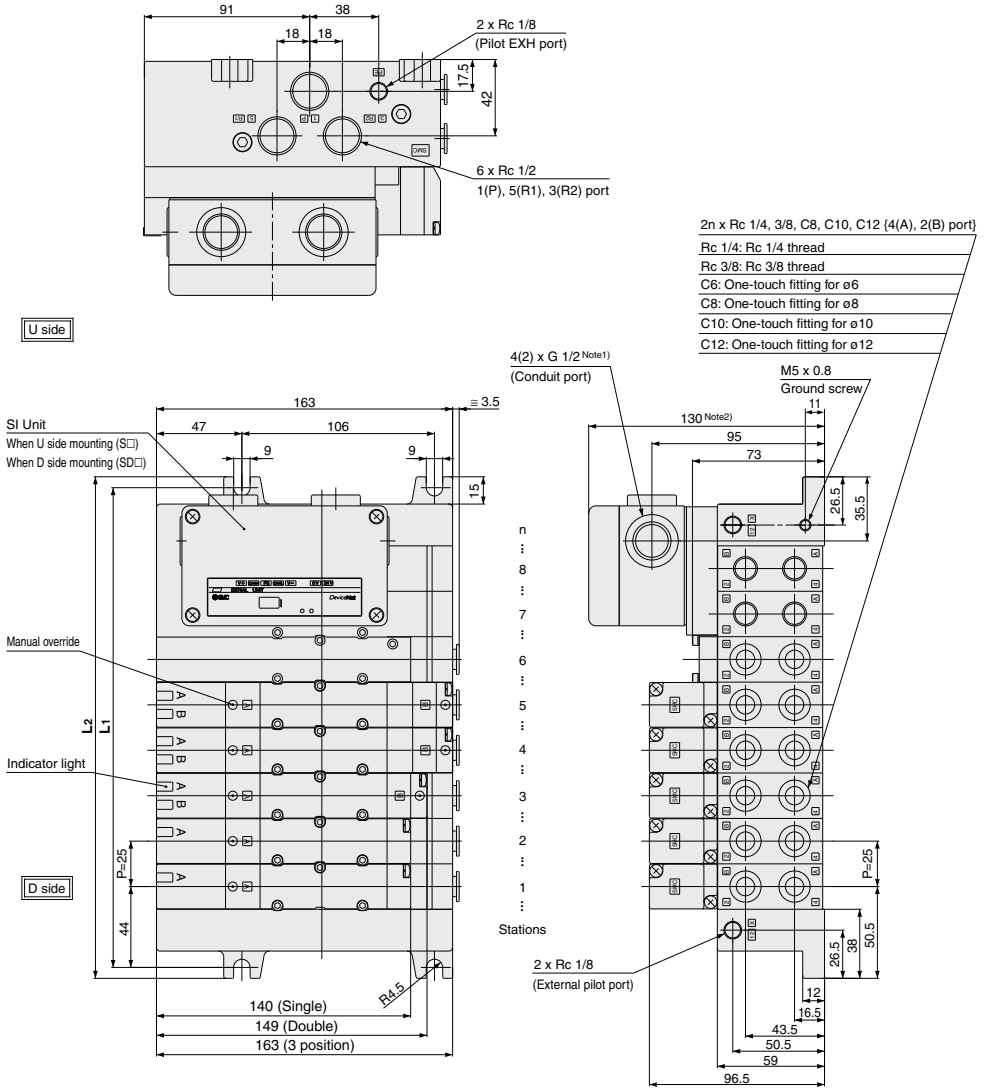

Note1) In the case of EX124 for SI unit, conduit port (G 1/2) will be 4 locations. In the case of EX123D (U), conduit port will be 2 locations.

Note2) In the case of EX124 (D)-SMJI, this dimension becomes 133.

Note) Shown VV5Q41-08C12SQ-W

Formula  $L1 = 25n + 63$ ,  $L2 = 25n + 76$  n: Station (Maximum standard 18 stations)  
 \* Including 2 stations for mounting SI unit box.

### Dimensions

L	n	3	4	5	6	7	8	9	10	11	12	13	14	15	16	17	18
L1		138	163	188	213	238	263	288	313	338	363	388	413	438	463	488	513
L2		151	176	201	226	251	276	301	326	351	376	401	426	451	476	501	526

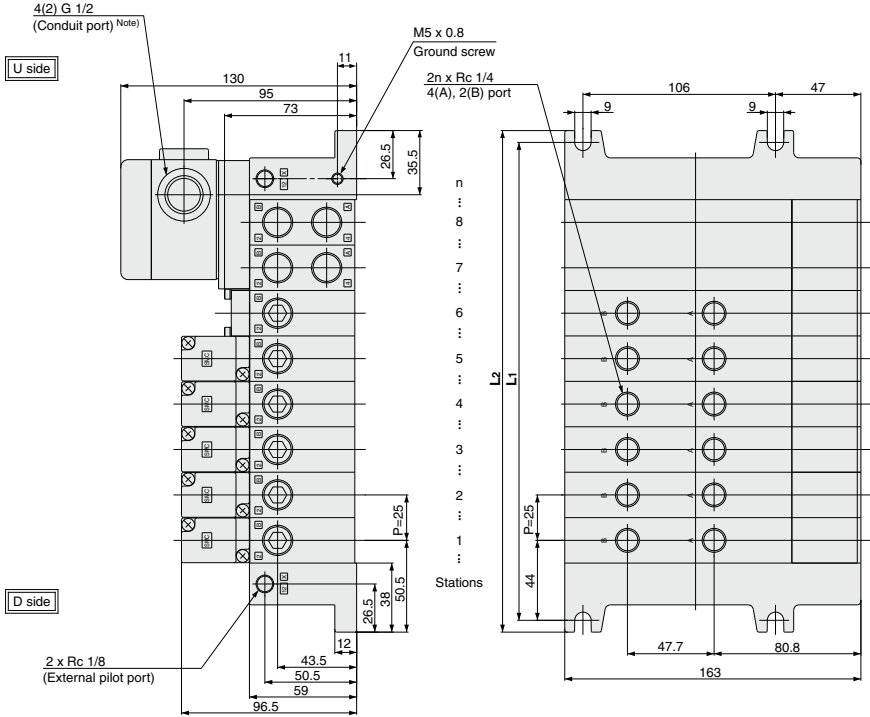

- SJ
- SY
- SY
- SV
- SYJ
- SZ
- VF
- VP4
- S0700
- VQ
- VQ4**
- VQ5
- VQC
- VQC4
- VQZ
- SQ
- VFS
- VFR
- VQ7

Formula  $L1 = 25n + 63$ ,  $L2 = 25n + 76$  n: Station (Maximum standard 18 stations)  
\* Including 2 stations for mounting SI unit box.

**Dimensions**

L	n	3	4	5	6	7	8	9	10	11	12	13	14	15	16	17	18
L1		138	163	188	213	238	263	288	313	338	363	388	413	438	463	488	513
L2		151	176	201	226	251	276	301	326	351	376	401	426	451	476	501	526

# Base Mounted

## Plug Lead Unit: C Kit (Connector kit)

# Series VQ4000



### How to Order Manifold

**VV5Q 4 5 - 08 C8 C - W -**

**Series**  
4 VQ4000

**Manifold**  
5 Plug lead unit

**Stations**

01	1 station
⋮	⋮
16	16 stations

**Cylinder port**

C6	With One-touch fitting for ø6
C8	With One-touch fitting for ø8
C10	With One-touch fitting for ø10
C12	With One-touch fitting for ø12
02	Rc 1/4
03	Rc 3/8
B	Bottom ported Rc 1/4
CM	Mixed

**Kit type**  
C kit (Connector)

**Thread type**

NII	Rc
F	G
T	NPT/NPTF

**CE-compliant**

NII	—
Q	CE-compliant

**Option**

Symbol	Option
NII	None
CD <sup>(2)</sup>	Exhaust cleaner: For D side mounting
CU <sup>(2)</sup>	Exhaust cleaner: For U side mounting
SB	Direct exhaust with silencer box: Exhaust from both sides
SD <sup>(2)</sup>	Direct exhaust with silencer box: D side exhaust
SU <sup>(2)</sup>	Direct exhaust with silencer box: U side exhaust
W	IP65 enclosure

Note 1) When two or more symbols are specified, indicate them alphabetically.  
Example) -CDW  
Note 2) Combination of [C<sup>(2)</sup>] and [S<sup>(2)</sup>] is not available.

**Control unit**  
Refer to pages 1098 to 1101.

Refer to page 1107 (Grommet type) for wiring specifications.

### How to Order Valves

**VQ 4 1 5 0 - 5 G -**

**Series**  
4 VQ4000

**Type of actuation**

1	2 position single
2	2 position double
3	3 position closed center
4	3 position exhaust center
5	3 position pressure center
6	3 position double check

**Seal**

0	Metal seal
1	Rubber seal

**Function**

NII	Standard type (1 W)
Y <sup>(1)</sup>	Low wattage type (0.5 W)
R <sup>(2)</sup>	External pilot

Note 1) Applicable to DC specifications. Please select when you expect to energize the unit for extended periods of time. Refer to page 3 for details.  
Note 2) For external pilot specifications, refer to page 1097. Combination of the external pilot and perfect interface is not possible.  
Note 3) When two or more symbols are specified, indicate them alphabetically.

**Coil voltage**

1	100 VAC (50/60 Hz)	4	220 VAC (50/60 Hz)
2	200 VAC (50/60 Hz)	5	24 VDC
3	110 VAC (50/60 Hz)	6	12 VDC

**CE-compliant**

NII	—
Q	CE-compliant

**Enclosure**

NII	Dusttight
W	Dusttight/Low jetproof type (IP65)

**Manual override**

NII:	Non-locking push type (Tool required)
B:	Locking type (Tool required)

**Light/Surge voltage suppressor**

NII	Yes
E	Without light, with surge voltage suppressor

**Electrical entry**

G	Lead wire length 0.6 m
H	Lead wire length 1.5 m

### How to Order Manifold Assembly

Specify the part numbers for valves and options together beneath the manifold base part number.

#### <Example>

Connector kit  
**VV5Q45-05C12C(Q)-1 set**—Manifold base part no.  
 \*VQ4150-5G(Q).....2 sets—Valve part no. (Stations 1 and 2)  
 \*VQ4250-5G(Q).....2 sets—Valve part no. (Stations 3 and 4)  
 \*VQ4350-5G(Q)-1 set—Valve part no. (Station 5)

Prefix the asterisk to the part nos. of the solenoid valve, etc.

Enter in order starting from the first station on the D side. When entry of part numbers becomes complicated, indicate in the manifold specification sheet.

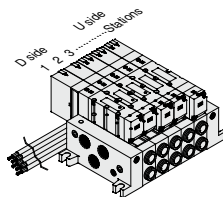

Simple specials are available with SMC Simple Special System.  
For details, refer to the SMC website.



**Manifold Specifications**

Series	Base model	Type of connection	Porting specifications		Maximum applicable stations	Applicable solenoid valve	Weight (kg) (Formula)	
			4(A), (B) port location	Port size <sup>Note)</sup>				
				1(P), 5(R1), 3(R2)				4(A), 2(B)
VQ4000	VVQ45-□□□	■ C kit-Grommet	Side	Rc 1/2 Option (Direct exhaust with silencer box)	C8 (For ø8) C10 (For ø10) C12 (For ø12) Rc 1/4 Rc 3/8	2 to 16 stations	VQ4□50 VQ4□51	0.31n+0.55 • Except solenoid valve weight
			Bottom		Rc 1/4			

Note) For details about inch-size One-touch fittings and other thread standards, refer to page 1097.

n: Stations

**Flow Characteristics at the Number of Manifold Stations (Operated individually)**

Model	Passage/Stations	Station 1	Station 5	Station 10	Station 15	
2 position metal seal VQ4 <sub>2</sub> 50	1 → 4/2 (P → A/B)	C [dm <sup>3</sup> /(s·bar)]	5.9	5.9	5.9	5.9
		b	0.23	0.23	0.23	0.23
		Cv	1.5	1.5	1.5	1.5
	4/2 → 5/3 (A/B → EA/EB)	C [dm <sup>3</sup> /(s·bar)]	6.2	6.2	6.2	6.2
		b	0.19	0.19	0.19	0.19
		Cv	1.5	1.5	1.5	1.5
2 position rubber seal VQ4 <sub>2</sub> 51	1 → 4/2 (P → A/B)	C [dm <sup>3</sup> /(s·bar)]	6.8	6.8	6.8	6.8
		b	0.31	0.31	0.31	0.31
		Cv	1.8	1.8	1.8	1.8
	4/2 → 5/3 (A/B → EA/EB)	C [dm <sup>3</sup> /(s·bar)]	7.0	7.0	7.0	7.0
		b	0.38	0.38	0.38	0.38
		Cv	1.9	1.9	1.9	1.9

Note) Port size: Rc 3/8

**Manifold Options**

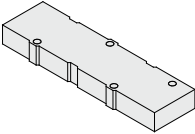
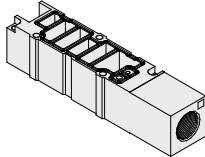
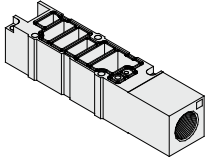
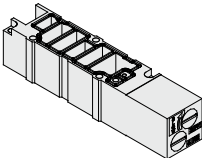
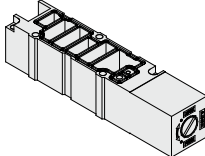
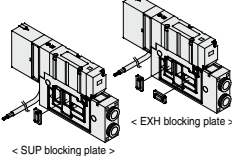
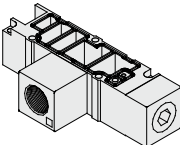
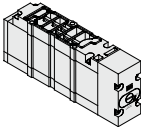
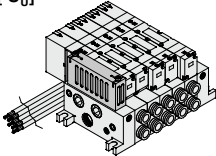
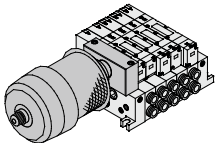
<p><b>Blanking plate assembly</b> VVQ4000-10A-5</p> 	<p><b>Individual SUP spacer</b> VVQ4000-P-5-<sub>02</sub><sub>03</sub></p> 	<p><b>Individual EXH spacer</b> VVQ4000-R-5-<sub>02</sub><sub>03</sub></p> 	<ul style="list-style-type: none"> <li>• Refer to pages 1092 to 1096 for detail dimensions of each option.</li> <li>• For replacement parts, refer to page 1105.</li> <li>• Refer to pages 1098 to 1101 for control unit.</li> </ul>
<p><b>Throttle valve spacer</b> VVQ4000-20A-5</p> 	<p><b>SUP stop valve spacer</b> VVQ4000-37A-5</p> 	<p><b>SUP/EXH block plate</b> VVQ4000-16A</p>  <p>&lt; SUP blocking plate &gt; &lt; EXH blocking plate &gt;</p>	
<p><b>Release valve spacer</b> VVQ4000-24A-5D<sup>Note)</sup></p> 	<p><b>Double check spacer with residual pressure exhaust</b> VVQ4000-25A-5<sup>Note)</sup></p> 	<p><b>Direct exhaust with silencer box</b> [-S□]<sup>Note)</sup></p> 	<p><b>For exhaust cleaner mounting</b> [-C□]<sup>Note)</sup></p> 

Note) Release valve spacer, built-in silencer (direct exhaust), exhaust cleaner mounting style and perfect double check spacer for residual pressure exhaust cannot be combined with external pilot.

SJ  
SY  
SY  
SV  
SYJ  
SZ  
VF  
VP4  
S0700  
VQ  
VQ4  
VQ5  
VQC  
VQC4  
VQZ  
SQ  
VFS  
VFR  
VQ7

# Series VQ4000

## C Kit (Connector kit)

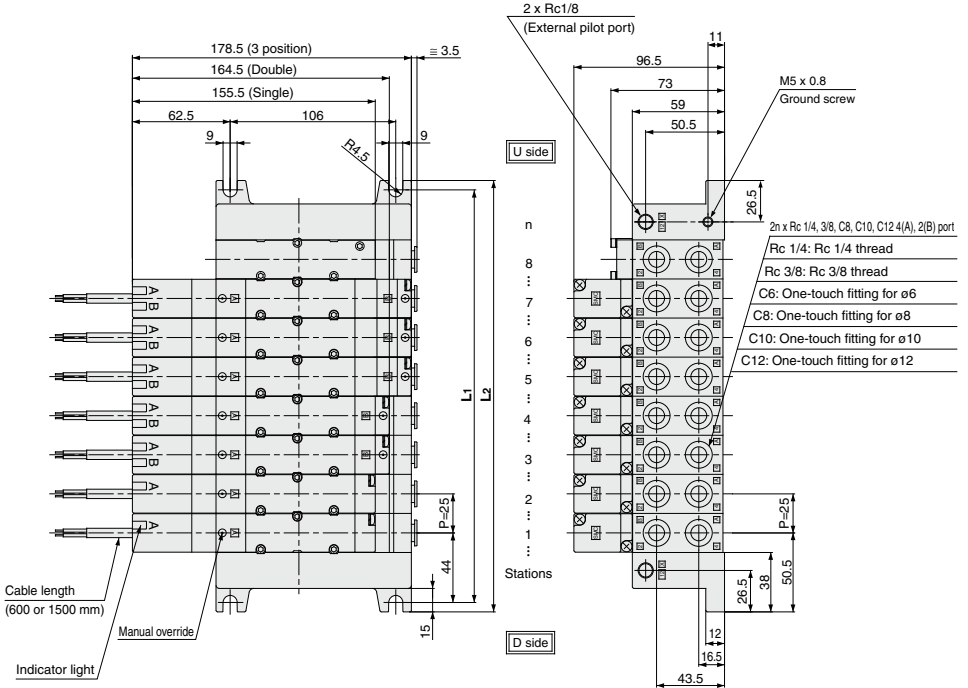
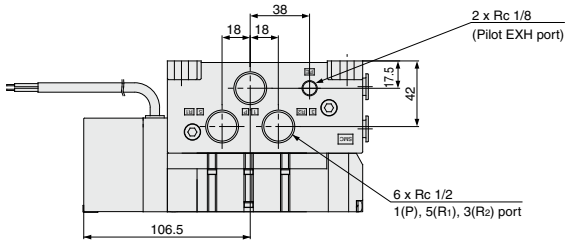

**Bottom ported drawing**

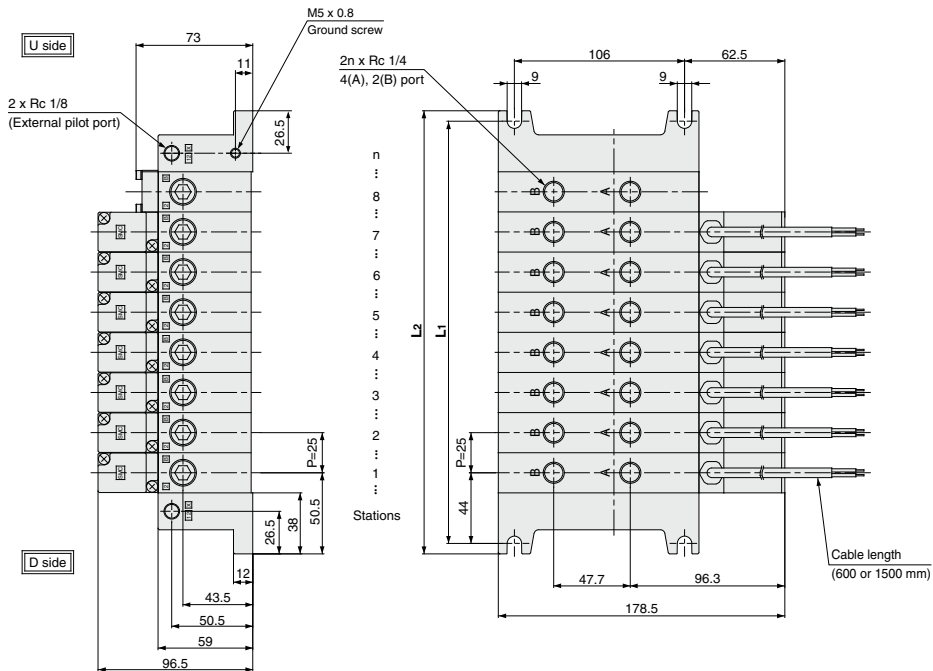

- SJ
- SY
- SY
- SV
- SYJ
- SZ
- VF
- VP4
- S0700
- VQ
- VQ4**
- VQ5
- VQC
- VQC4
- VQZ
- SQ
- VFS
- VFR
- VQ7

**Dimensions** Formula  $L1 = 25n + 63$ ,  $L2 = 25n + 76$  n: Station (Maximum 16 stations)

L	n	1	2	3	4	5	6	7	8	9	10	11	12	13	14	15	16
L1		88	113	138	163	188	213	238	263	288	313	338	363	388	413	438	463
L2		101	126	151	176	201	226	251	276	301	326	351	376	401	426	451	476

# Series VQ4000

## Manifold Option Parts

### Blanking plate assembly

#### VVQ4000-10A-1 (Plug-in type) VVQ4000-10A-5 (Plug lead type)

It is used by attaching on the manifold block for being prepared for removing a valve for maintenance reasons or planning to mount a spare valve, etc.

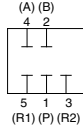
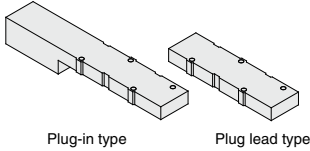

Circuit diagram

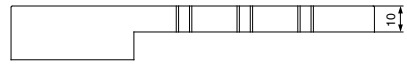
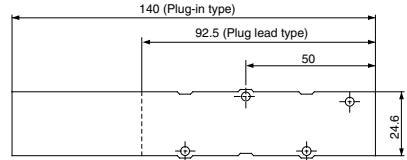

### Individual SUP spacer

#### VVQ4000-P-1- $\frac{02}{03}$ (Plug-in type) VVQ4000-P-5- $\frac{02}{03}$ (Plug lead type)

By mounting individual SUP spacers on a manifold block, it is possible to provide individual supply ports for each valve.

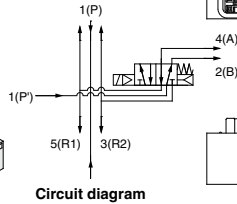
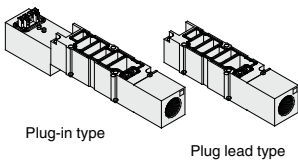

Circuit diagram

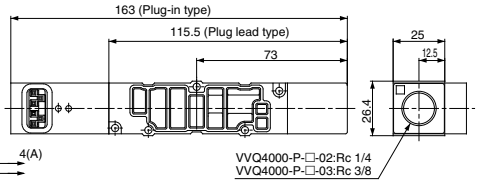

### Individual EXH spacer

#### VVQ4000-R-1- $\frac{02}{03}$ (Plug-in type) VVQ4000-R-5- $\frac{02}{03}$ (Plug lead type)

By mounting individual EXH spacers on a manifold block, exhaust ports can be provided individually for each valve. (Common EXH type)

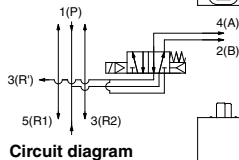
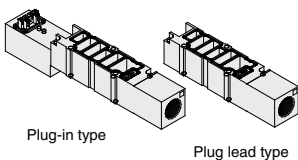

Circuit diagram

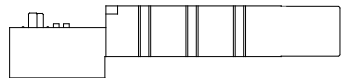
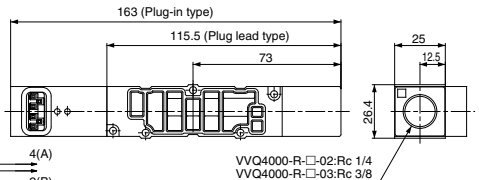

**Throttle valve spacer**

**VVQ4000-20A-1 (Plug-in type)**  
**VVQ4000-20A-5 (Plug lead type)**

A throttle valve spacer is mounted on a manifold block to control cylinder speed by throttling exhaust air flow.

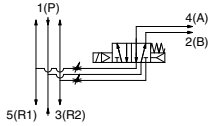
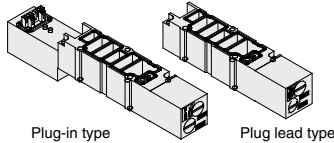

**Circuit diagram**

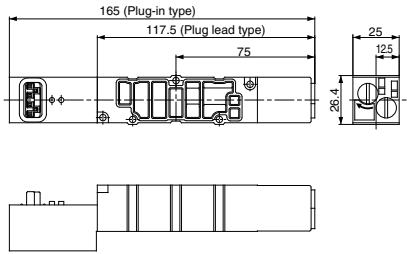

**SUP stop valve spacer**

**VVQ4000-37A-1 (Plug-in type)**  
**VVQ4000-37A-5 (Plug lead type)**

A SUP stop valve spacer is mounted on a manifold block, making it possible to individually shut off supply air to each valve.

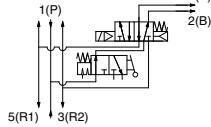
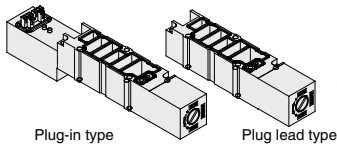

**Circuit diagram**

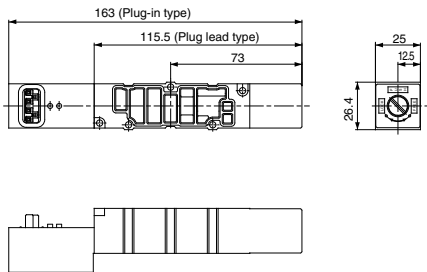

**Release valve spacer: For D side mounting**

**VVQ4000-24A-1D (Plug-in type)**  
**VVQ4000-24A-5D (Plug lead type)**

Combination of VQ41□□ (Single) and release valve spacer can be used as air release valve.

Note 1) Mounting on 2 position double and 3 position valve is not possible.  
 Note 2) Can be mounted on L kit only. For other kits, order E type control unit. (Refer to pages 1098 to 1101.)

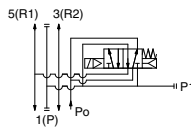
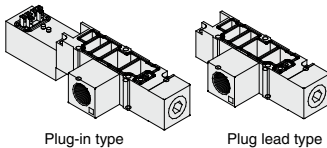

**Circuit diagram**

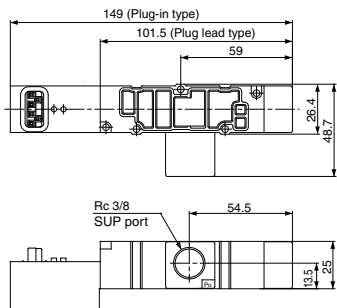

**SUP/EXH block plate**

**VVQ4000-16A**

When supplying two different pressures to one manifold, this is used to shut off between stations with different pressures.

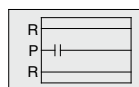
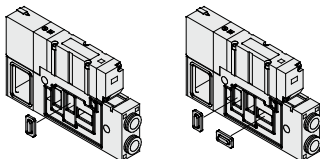

SUP passage blocked

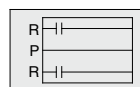

EXH passage blocked

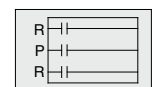

SUP/EXH passage blocked

<SUP blocking plate >

<EXH blocking plate >

SJ
SY
SY
SV
SYJ
SZ
VF
VP4
S0700
VQ
<b>VQ4</b>
VQ5
VQC
VQC4
VQZ
SQ
VFS
VFR
VQ7

# Series VQ4000

## Manifold Option Parts

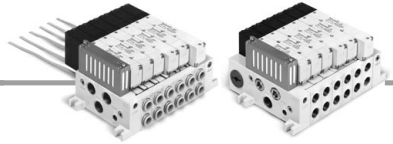

### Direct exhaust with silencer box

VV5Q4 $\frac{1}{2}$ -□□□-SB (Exhaust from both sides)

VV5Q4 $\frac{1}{2}$ -□□□-SD (D side exhaust)

VV5Q4 $\frac{1}{2}$ -□□□-SU (U side exhaust)

The EXH outlet is placed on the top side of the manifold end plate. The built-in silencer provides highly effective noise reduction.

(Noise reduction of 35 dB or more)

Effective area: 60.2 mm<sup>2</sup>

Note) If a lot of drainage is generated at air supply source, both of exhaust air and drainage are exhausted.

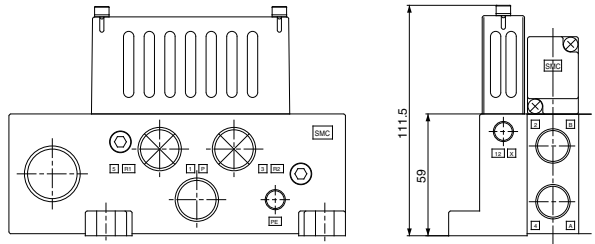
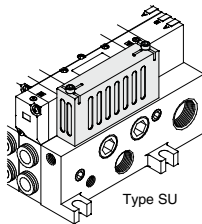
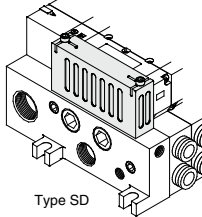
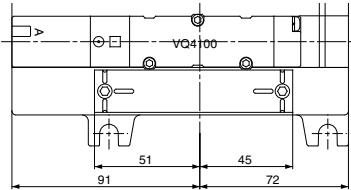

Note) Figure shows VV5Q41-□□□-SD.

● Silencer box assembly: VVQ4000-33A (With gasket, screw)

### Double check spacer with residual pressure exhaust

VVQ4000-25A-1 (Plug-in type)

VVQ4000-25A-5 (Plug lead type)

Can hold an intermediate cylinder position for an extended time.

If the double check spacer with a built-in double check valve is combined, it will enable the cylinder to stop in the intermediate stroke and maintain its position for a long time without being affected by the leakage between the spools.

Besides, combination between 2 position solenoid valve (VQ4 $\frac{1}{2}$ □□) and double check spacer can't hold an intermediate position, but can prevent dropping at the cylinder stroke end.

### Specifications

VVQ4000-25A- $\frac{1}{5}$		
Double check spacer part no.	Intermediate stop	Drop prevention
Applicable solenoid valve	VQ44□□	VQ4 $\frac{1}{2}$ □□

### ⚠ Caution

#### Handling Precautions

- Air leakage from the pipe between the valve and cylinder or from the fittings will prevent the cylinder from stopping in the middle for a long time. Check for leakage using a neutral household detergent, such as dish washing soap. Also, check the cylinder sealing and piston seal for leakage.
- Since One-touch fittings allow slight air leakage, screw piping is recommended when stopping the cylinder in the middle for a long time.
- If exhaust side of double check spacer is narrowed down, this causes a decrease in intermediate stop accuracy and may malfunction.
- Combining perfect interface with 3 position valves "VQ4 $\frac{1}{2}$ □□" will not work.
- Set the cylinder load so that the cylinder pressure will be within two times that of the supply pressure.
- Combining double check spacer with external pilot will not work.

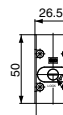
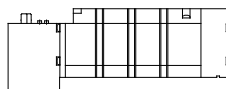
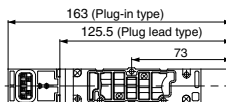
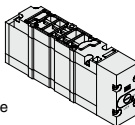
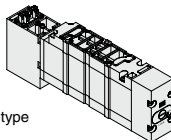

Manual override for residual pressure exhaust  
Slotted locking type (Tool required)

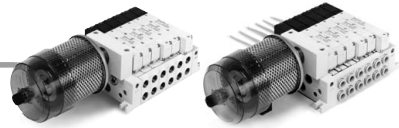

## Manifold mounted exhaust cleaner

VV5Q4 1/2-□□□-CD (D side mounting)

VV5Q4 1/2-□□□-CU (U side mounting)

An adapter plate for exhaust cleaner mounting is provided on the top of the manifold end plate. The exhaust cleaner collects drainage and oil mist (99.9% or more) and is highly effective for noise reduction.

(Noise reduction of 35 dB or more)

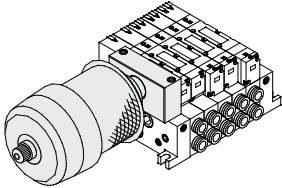

### Applicable exhaust cleaners

AMC610-10 (Port size Rc 1)

Note 1) Exhaust cleaner AMC610-10 is not attached.

Please order it separately.

Note 2) Mount so that the exhaust cleaner is at the lower side.

Note 3) For details about the exhaust cleaner, refer to Best Pneumatics No. 6.

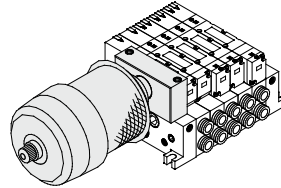

### Plug-in type

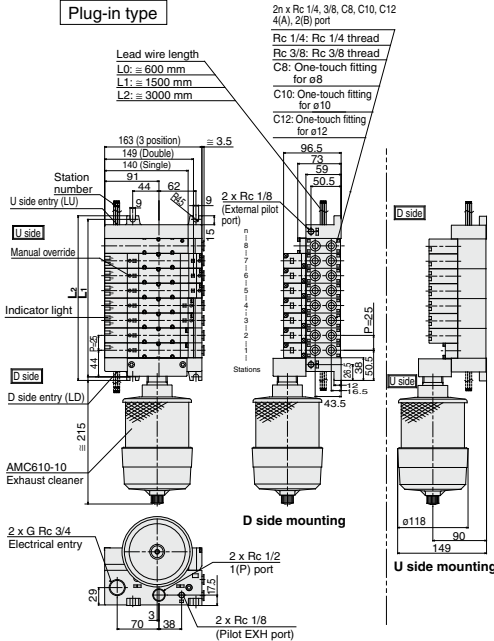

### Plug lead type

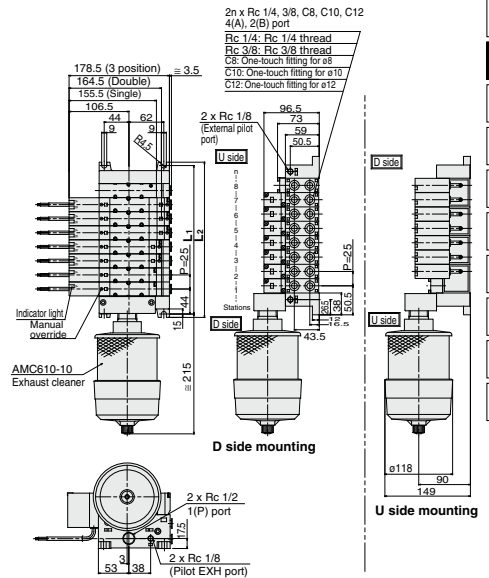

### Dimensions

Formula L1 = 25n + 63, L2 = 25n + 76  
n: Stations (Maximum 16 stations)

L	n	1	2	3	4	5	6	7	8
L1		88	113	138	163	188	213	238	263
L2		101	126	151	176	201	226	251	276
L	n	9	10	11	12	13	14	15	16
L1		288	313	338	363	388	413	463	463
L2		301	326	351	376	401	426	476	476

### Dimensions

Formula L1 = 25n + 63, L2 = 25n + 76  
n: Stations (Maximum 16 stations)

L	n	1	2	3	4	5	6	7	8
L1		88	113	138	163	188	213	238	263
L2		101	126	151	176	201	226	251	276
L	n	9	10	11	12	13	14	15	16
L1		288	313	338	363	388	413	463	463
L2		301	326	351	376	401	426	476	476

- SJ
- SY
- SY
- SV
- SYJ
- SZ
- VF
- VP4
- S0700
- VQ
- VQ4**
- VQ5
- VQC
- VQC4
- VQZ
- SQ
- VFS
- VFR
- VQ7

# Series VQ4000

## Manifold Option Parts

### Interface regulator (P, A, B port regulation)

ARBQ4000-00-□-1 (Plug-in type)

ARBQ4000-00-□-5 (Plug lead type)

Spacer interface regulators can be placed on top of the manifold block to reduce the pressure of each of the valves.

## Specifications

Interface regulator		ARBQ4000					
Regulating port		A		B		P	
Applicable solenoid valve		Plug-in	Plug lead	Plug-in	Plug lead	Plug-in	Plug lead
Maximum operating pressure		1.0 MPa					
Set pressure range		0.05 to 0.85 MPa					
Fluid		Air					
Ambient and fluid temperature		-5 to 60°C (No freezing)					
Port size for connection of pressure gauge		M5 x 0.8					
Weight (kg)		0.33	0.30	0.33	0.30	0.33	0.30
Effective area at supply side (mm <sup>2</sup> )		P → A		P → B		P → P	
S at P <sub>1</sub> = 0.7 MPa/P <sub>2</sub> = 0.5 MPa		15		31		14	
Effective area at exhaust side (mm <sup>2</sup> )		A → EA		B → EB		P → P	
S at P <sub>2</sub> = 0.5 MPa		18		40		40	
		37		19		37	

- Note 1) Set the pressure within the operating pressure range of the solenoid valve.  
 Note 2) Operate an interface regulator only by applying pressure from the P port of the base, except when using it as a reverse pressure valve. When using it as a reverse pressure valve, P port regulation is not allowed to use.  
 Note 3) When using a perfect spacer, assemble a valve, a spacer regulator and a perfect spacer in this order to use it.  
 Note 4) When using in A port regulation, B port regulation by closed center, since there is a problem in its operation, please contact SMC.  
 Note 5) Dust tight/Low jetproof enclosure (IP65) is not available with interface regulator.

## How to Order

Solenoid Valve	Interface regulator	Regulating port
VQ4□□ (Plug-in type)	ARBQ4000-00-A-1	A
	ARBQ4000-00-B-1	B
	ARBQ4000-00-P-1	P
VQ4□5□ (Plug lead type)	ARBQ4000-00-A-5	A
	ARBQ4000-00-B-5	B
	ARBQ4000-00-P-5	P

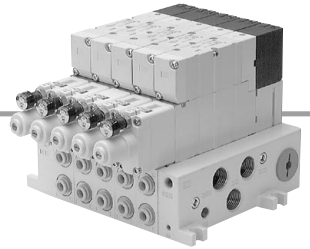
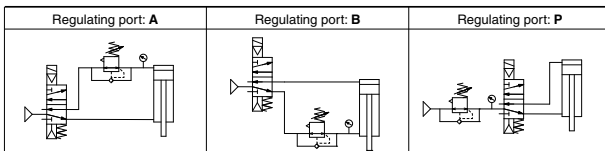
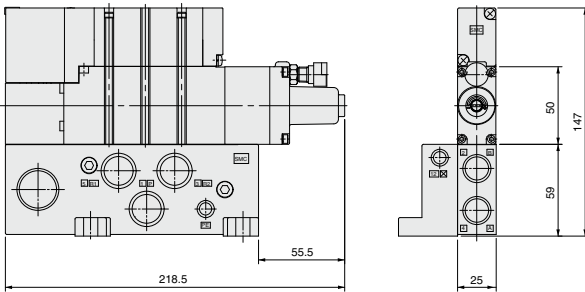

## Flow Characteristics

Conditions Inlet pressure: 0.7 MPa

ARBQ4000-00-A

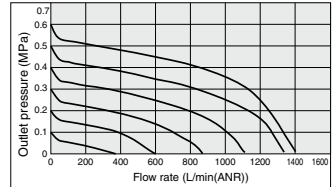

ARBQ4000-00-B

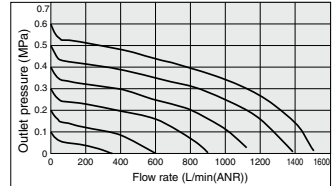

ARBQ4000-00-P (P → A)

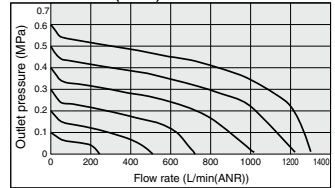

ARBQ4000-00-P (P → B)

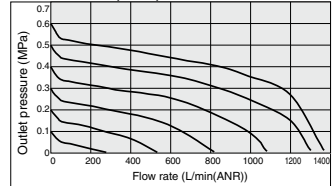

## Pressure Characteristics

Conditions

Inlet pressure: 0.7 MPa

Outlet pressure: 0.2 MPa

Flow rate: 20 L/min (ANR)

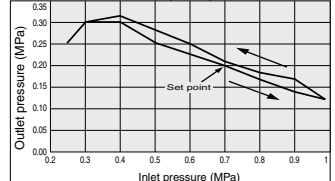



## Semi-standard Specifications

### External Pilot Specifications

- When the supply air pressure is:
  - lower than the required minimum operating pressure 0.15 to 0.2 MPa,
  - opposite air supply (R port supply), cylinder supply (A and B port supply),
  - used for vacuum specifications (please contact SMC),
 it can be used for external pilot specifications.
- Order a valve by adding the external pilot specification [R] to the part number. External pilot is available as standard for manifolds and options.
- Internal/external pilot can be mounted in a manifold.
- Compatibility with universal porting is possible for the single, double and 3P (excluding perfect spacer) types.

### How to Order Manifold

VQ4100 **[R]** - 5 - 03

● External pilot specifications

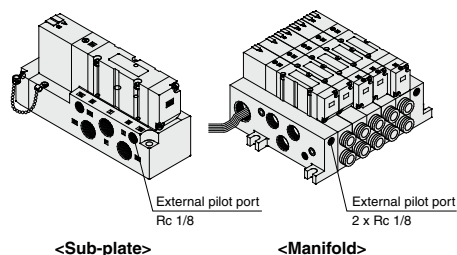

Note) Possible to mix mounting of internal and external pilot

### Pressure Specifications

Valve construction		Metal seal	Rubber seal
Operating pressure range		Vacuum to 1.0 MPa	
External pilot <sup>Note)</sup> pressure range	Single	0.15 to 1.0 MPa (0.15 to 0.7 MPa)	0.2 to 1.0 MPa (0.2 to 0.7 MPa)
	Double		0.15 to 1.0 MPa (0.15 to 0.7 MPa)
	3 position		0.2 to 1.0 MPa (0.2 to 0.7 MPa)

Note ) Values inside ( ) denote the low wattage (0.5 W) specifications.

Combination of manifold options shown below and external pilot specification is not possible.

Release valve spacer	VVQ4000-24A-□□
Direct exhaust with silencer box	VV5Q4□-□□□-□□
For exhaust cleaner mounting	VV5Q4□-□□□-□□
Manifold with control unit	VV5Q4□-□□□ <small>Control unit model no.</small>
Double check spacer with residual pressure exhaust	VVQ4000-25A- $\frac{1}{2}$

### Inch-size One-touch Fittings

Valve with inch size One-touch fittings is shown below.

### How to Order Single Valves

VV5Q41 - 06 **[N11]** SA - K

● Cylinder port

N7	ø1/4"
N9	ø5/16"
N11	ø3/8"

### International Thread Standards

Rc specifications are standard for all ports, however, NPT, NPTF and G are available for international markets. Add the appropriate symbol following the port size in the standard part number.

### How to Order Single Valves (Example)

VQ4100 - 5 - 03 **[T]**

● Cylinder port  
● Port size

● Thread type (P, R and A, B port)

Nil	Rc
N	NPT
T	NPTF
F	G

### How to Order Manifold

VV5Q41 - 08 03 **[T]** FU1

● Cylinder port  
● Port size

● Thread type (P, R and A, B port)

Nil	Rc
N	NPT
T	NPTF
F	G

VV5Q41 - 08 C8 **[T]** FU1

● Cylinder port  
● Port size

● Thread type (P, R port)

Nil	Rc
N	NPT
T	NPTF
F	G

### How to Order Sub-plates and Options (Example)

VQ4000 - P - B 02 **[N]** (Sub-plate)

VVQ4000 - P - 1 - 03 **[T]** (Option)

● Port size

● Thread type

Nil	Rc
N	NPT
T	NPTF
F	G

SJ
SY
SY
SV
SYJ
SZ
VF
VP4
S0700
VQ
VQ4
VQ5
VQC
VQC4
VQZ
SQ
VFS
VFR
VQ7

# Series VQ4000

## Manifold with Control Unit

- Mounting air filter, regulator, pressure switch for air release valve on manifold as unit is possible and permits piping labor savings.
- Maximum number of stations depends on each kit.
- Refer to manifold specifications.
- 2 stations are used for control unit mounting.  
(1 station is used for E type.)

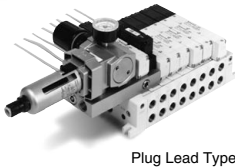
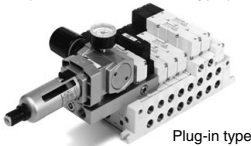

### Caution

In the case of air filters with auto-drain or manual drain, mount so that the air filter is at the bottom.

## Manifold Specifications

Base model	Type of connection	4(A), 2(B) port location	Porting specifications		Applicable max. stations <sup>(Note)</sup>	Applicable solenoid valve
			Port size			
			1(P), 5(R1), 3(R2)	4(A), 2(B)		
VV5Q41 -□□□	F kit – D-sub connector T kit – Terminal block box L kit – Lead wire	Side	Rc 1/2  Option (Direct exhaust with silencer box)	C8 (For ø8) C10 (For ø10) C12 (For ø12) Rc 1/4, Rc 3/8	F, T kit 14 stations (13 stations) L, C kit 18 stations (17 stations)	VQ4□00 VQ4□01
VV5Q45 -□□□	C kit – Connector	Bottom		Rc 1/4		VQ4□50 VQ4□51

Note) Manifold for mounting is included. ( ) : E type

## Control Unit Specifications

Air filter (With auto-drain/With manual drain)	
Filtration	5 μm
Regulator	
Set pressure (Outlet pressure)	0.05 to 0.85 MPa
Pressure switch <sup>(Note)</sup>	
Set pressure range: OFF	0.1 to 0.6 MPa
Differential	0.08 MPa or less
Contact	1a
Light	LED (RED)
Max. switch capacity	2 VA (AC), 2 W (DC)
Max. operating current	50 mA at 24 VAC, DC or less 20 mA at 100 VAC, DC
Air release valve (Single only)	
Operating pressure range	0.15 to 1 MPa (0.15 to 0.7 MPa)

Note) Values inside ( ) denote the low wattage (0.5 W) specifications.

## Control Unit/Option

Air release valve spacer <sup>(2)</sup>	<Plug-in type> VVQ4000-24A-1D	
	<Plug lead type> VVQ4000-24A-5D	
Pressure switch	IS1000P-2-1	
Blanking plate <sup>(3)</sup>	Regulator with filter	MP2-3
	Pressure switch	MP3-2
	Release valve	Plug-in VVQ4000-24A-10 Plug lead VVQ4000-24A-15
Filter element	INA-13-854-12-5B	

Note 1) Rated voltage: 24 VDC to 100 VAC  
Internal voltage drop: 4 V

Note 2) Combination of VQ41□□ (Single) and release valve spacer can be used as air release valve.

Note 3) Plug lead type can not be mounted later.

## How to Order Manifold

**VV5Q 4 1 - 08 C8 F U1**

Series: 4 VQ4000

Manifold: 1 Plug-in unit, 5 Plug Lead unit

Stations: 02 2 stations

Cylinder port: C6 One-touch fitting for ø6, C8 One-touch fitting for ø8, C10 One-touch fitting for ø10, C12 One-touch fitting for ø12, 02 Rc 1/4, 03 Rc 3/8, B Bottom ported Rc 1/4, CM Mixed

Thread type: Nil Rc, F G, T NPT/NPTF

Kit<sup>(5)</sup>: Air release valve coil rating

	Without air release valve (Only F.G type)
1	100 VAC, 50/60 Hz
5	24 VDC
9	Other

Control unit type

Symbol	Nil	A	AP	M	MP	F	G	C	E
Control equipment									
Air filter with auto-drain		●	●			●			
Air filter with manual drain				●	●		●		
Regulator		●				●			
Air release valve		●	●	●	●			●	●
Pressure switch			●		●				
Blanking plate (Air release valve)						●			
Blanking plate (Filter, Regulator)							●	●	
Blanking plate (Pressure switch)									●

Necessary number of manifold blocks from mounting required for mounting (Stations)

CE-compliant: Nil, Q CE-compliant

Option: Nil, Q CE-compliant

Symbol	Option
Nil	None
K <sup>(2)</sup>	Special wiring specifications (Except double wiring)
N	Name plate (Applicable to T kit)
SU <sup>(3)</sup>	Direct exhaust with silencer box: U side exhaust
W <sup>(4)</sup>	IP65 enclosure

Note 1) When two or more symbols are specified, indicate them alphabetically. Example) -KN

Note 2) Specify wiring on the manifold specification sheet.

Note 3) Mounting on S and T kits is not possible.

Note 4) Combination with pressure switch (AP and MP type) is not possible.

Note 5) The release valve and the pressure switch on S kit are connected to another power supply. Cable length is 0.6 m.

Note) Electrical entry: Control unit can not be removed except L and C kits.

**Use of Control Unit**

**<Construction and piping >**

1. The supply pressure (Po) passes through the filter regulator (1) and is adjusted to the prescribed pressure. Next, it goes through the release valve (2) (outlet residual pressure switching function used as normally ON) and is supplied to the manifold base side (P).
2. Supply pressure from Po port is blocked when release valve (2) is OFF. Air supplied to manifold side P port is exhausted to R1 port through release valve (2).
3. Pressure switch is piped at outlet side of release valve (2). (Release valve (2) is operated at energizing.)  
Also, since there is an internal voltage drop of 4 V, it may not be possible to confirm the OFF and ON states with a tester, etc.

**<Wiring >**

1. Electrical entry of manifold (except L and C kit) is individual wiring. For details, refer to internal wiring figure of each kit. Cable length is 0.6 m for L kit.

**<Change of pressure switch piping >**

1. Pressure switch (3) is changed to piping on inlet side of release valve (2), remove the pressure switch, reverse the gasket up and down, and fix **[B]** mark.
2. When pressure switch is mounted, tightening torque of bolt is 0.8 to 1.2 N·m.

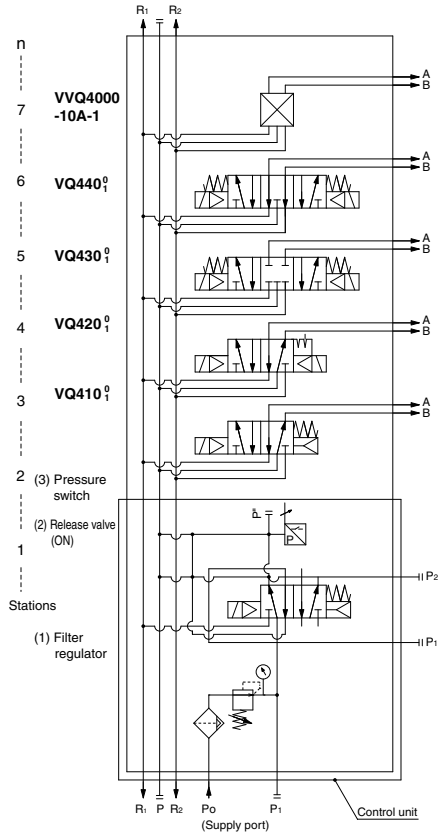
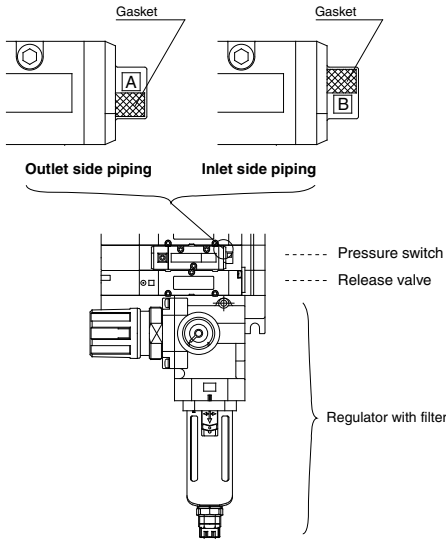

**Circuit of control unit manifold**

SJ
SY
SY
SV
SYJ
SZ
VF
VP4
S0700
VQ
<b>VQ4</b>
VQ5
VQC
VQC4
VQZ
SQ
VFS
VFR
VQ7

# Series VQ4000

## Manifold with Control Unit

### Plug-in type

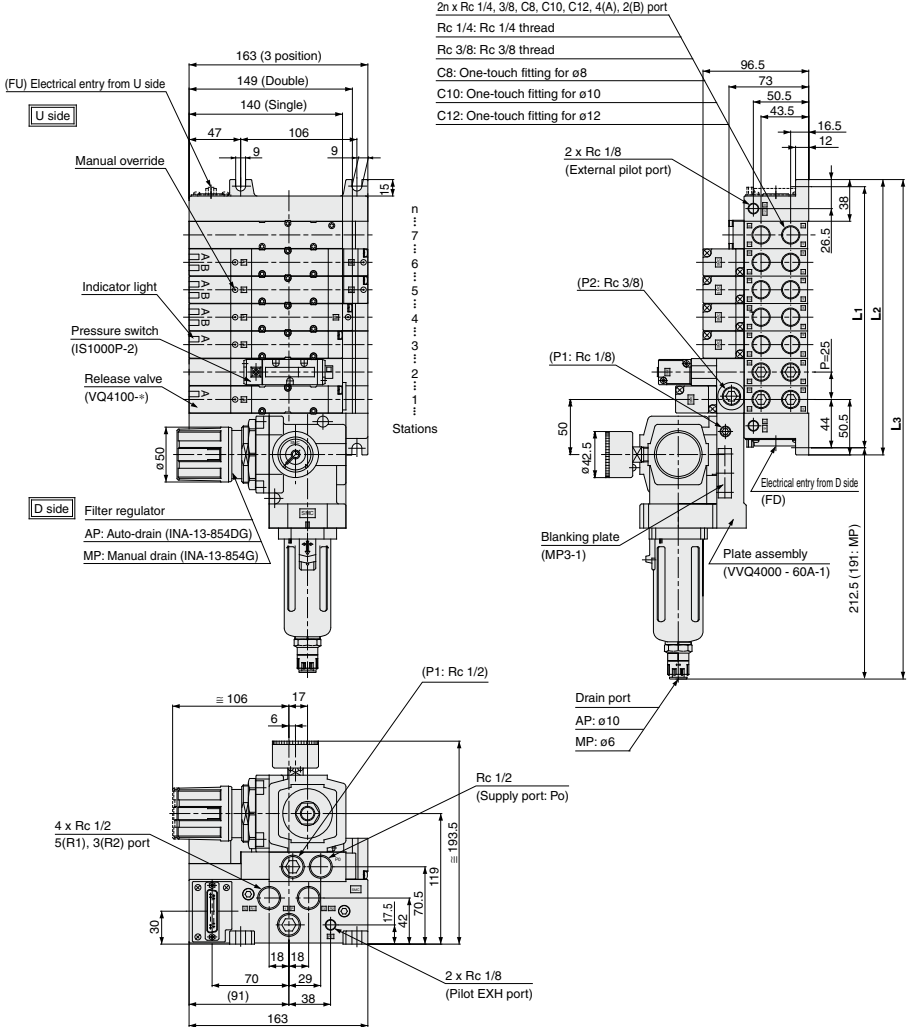

### Dimensions

Formula L1 = 25n + 63, L2 = 25n + 76, L3 = 25n + 282 (260.5) n: Stations

L \ n	2	3	4	5	6	7	8	9	10	11	12
L1	113	138	163	188	213	238	263	288	313	338	363
L2	126	151	176	201	226	251	276	301	326	351	376
L3	332	357	382	407	432	457	482	507	532	557	582
	(310.5)	(335.5)	(360.5)	(385.5)	(410.5)	(435.5)	(460.5)	(485.5)	(510.5)	(535.5)	(560.5)

\* L3 ( ) : Type MP

**Plug lead type**

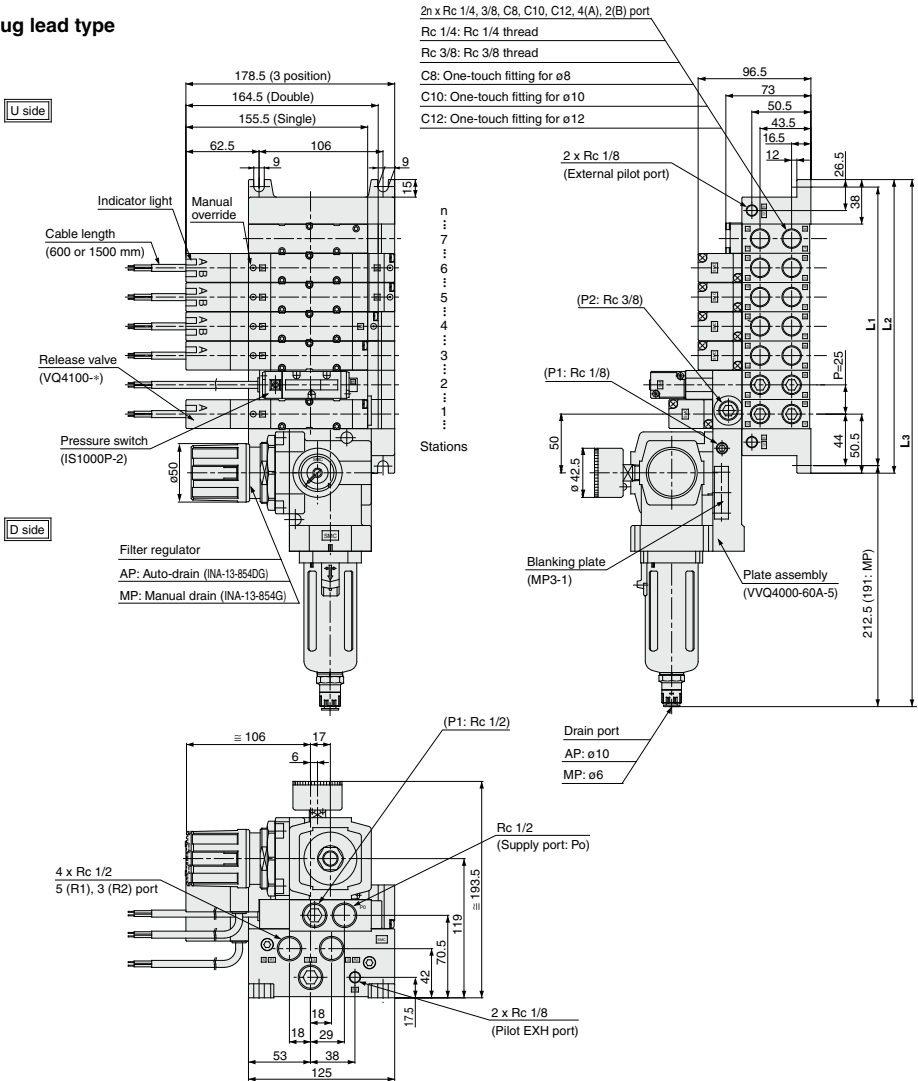

**Dimensions**

Formula L1 = 25n + 63, L2 = 25n + 76, L3 = 25n + 282 (260.5) n: Stations

L \ n	2	3	4	5	6	7	8	9	10	11	12
L1	113	138	163	188	213	238	263	288	313	338	363
L2	126	151	176	201	226	251	276	301	326	351	376
L3	332 (310.5)	357 (335.5)	382 (360.5)	407 (385.5)	432 (410.5)	457 (435.5)	482 (460.5)	507 (485.5)	532 (510.5)	557 (535.5)	582 (560.5)

\* L3 ( ): Type MP

- SJ
- SY
- SY
- SV
- SYJ
- SZ
- VF
- VP4
- S0700
- VQ
- VQ4**
- VQ5
- VQC
- VQC4
- VQZ
- SQ
- VFS
- VFR
- VQ7

# Series VQ4000 Construction

## Plug-in Unit

### Metal seal type

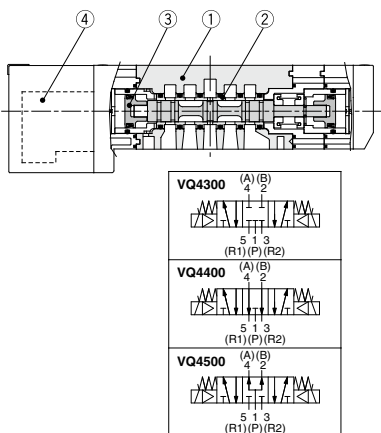
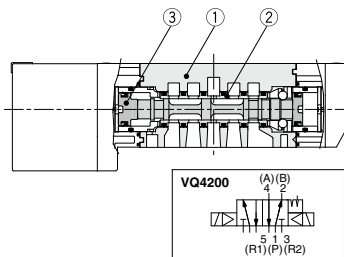
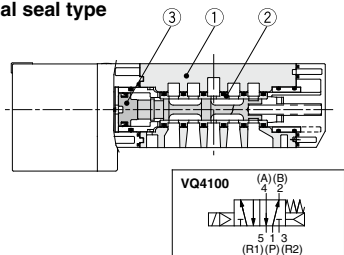

### Component Parts

Number	Description	Material	Note
①	Body	Aluminum die-casted	
②	Spool/Sleeve	Stainless steel	
③	Piston	Resin	

### Replacement Parts

④	Pilot valve assembly	VQZ111P-□- A B E	□: Coil rated voltage Example) 24 VDC: 5 A: With A side light B: With B side light E: Without a light (Common for A and B)
---	----------------------	---------------------------	---

### Rubber seal type

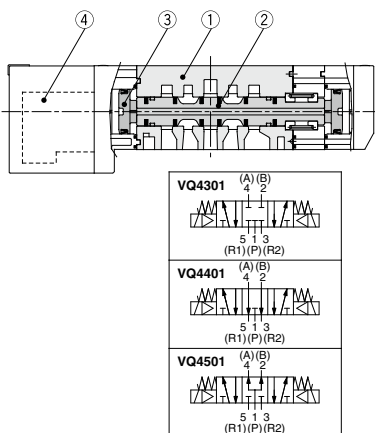
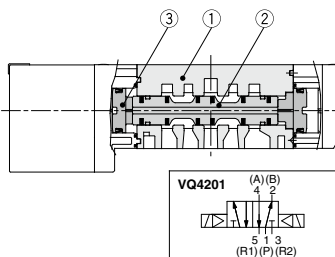
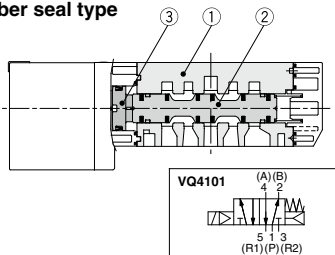

### Component Parts

Number	Description	Material	Note
①	Body	Aluminum die-casted	
②	Spool valve	Aluminum, HNBR	
③	Piston	Resin	

### Replacement Parts

④	Pilot valve assembly	VQZ111P-□- A B E	□: Coil rated voltage Example) 24 VDC: 5 A: With A side light B: With B side light E: Without a light (Common for A and B)
---	----------------------	---------------------------	---

# Series VQ4000 Construction

## Plug Lead Unit

### Metal seal type

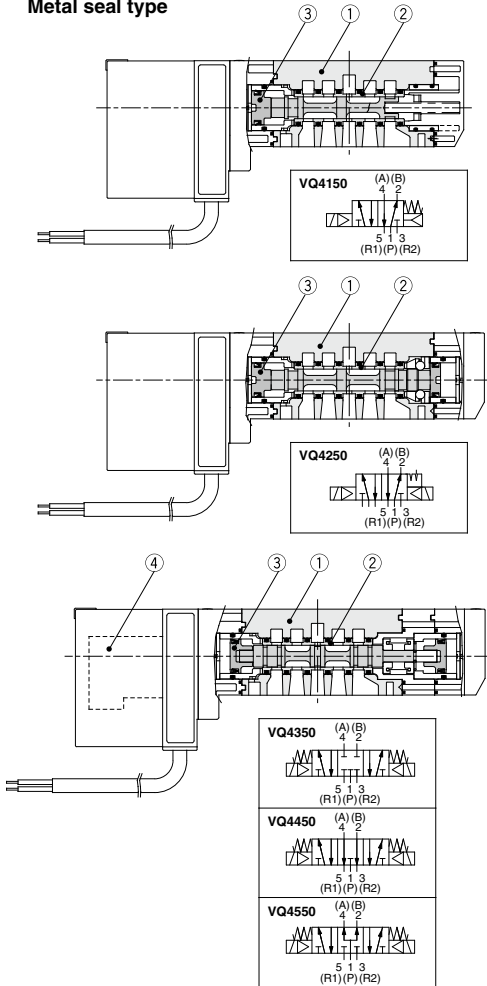

### Component Parts

Number	Description	Material	Note
①	Body	Aluminum die-casted	
②	Spool/Sleeve	Stainless steel	
③	Piston	Resin	

### Replacement Parts

④	Pilot valve assembly	VQZ111P-□- A B E	<input type="checkbox"/> : Coil rated voltage Example) 24 VDC: 5 A: With A side light B: With B side light E: Without a light (Common for A and B)
---	----------------------	---------------------------	---

### Rubber seal type

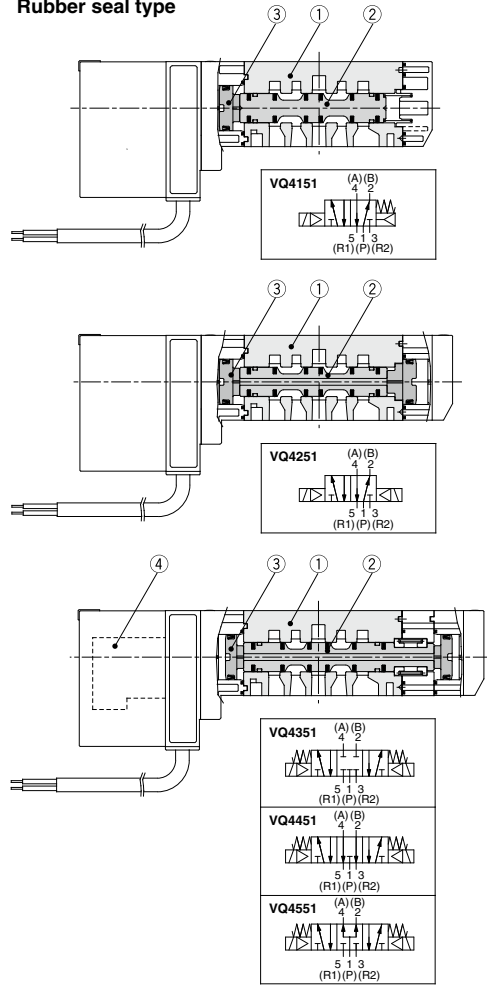

### Component Parts

Number	Description	Material	Note
①	Body	Aluminum die-casted	
②	Spool valve	Aluminum, HNBR	
③	Piston	Resin	

### Replacement Parts

④	Pilot valve assembly	VQZ111P-□- A B E	<input type="checkbox"/> : Coil rated voltage Example) 24 VDC: 5 A: With A side light B: With B side light E: Without a light (Common for A and B)
---	----------------------	---------------------------	---

SJ  
SY  
SY  
SV  
SYJ  
SZ  
VF  
VP4  
S0700  
VQ  
VQ4  
VQ5  
VQC  
VQC4  
VQZ  
SQ  
VFS  
VFR  
VQ7

# Exploded View of Manifold

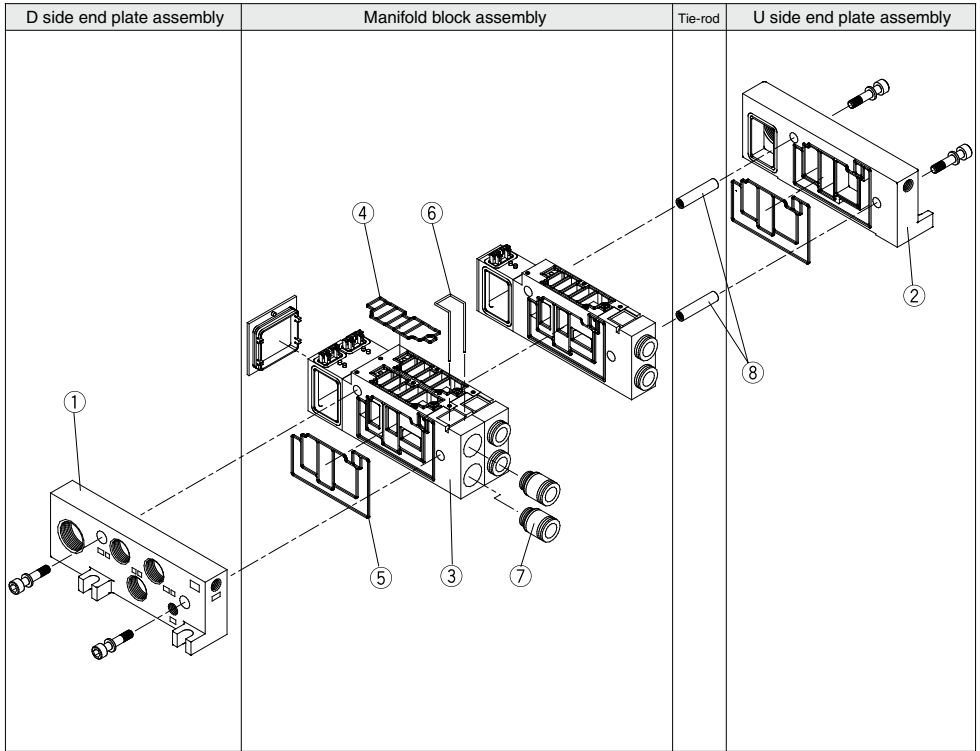

Note) The electrical entry cannot be changed.

The drawing shows a plug-in type.

D side

U side

Example) 1.....2.....3.....4.....5.....6.....Stations

5 stations (Odd number)    2 stations | 2 stations | 1 station

6 stations (Even number)    2 stations | 2 stations | 2 stations



# Exploded View of Manifold

## <D Side End Plate Assembly>

1. D side end plate assembly no. (For F, L, S, T kit)

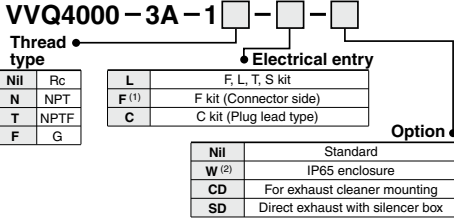

Note 1) D-sub connector assembly for D side:  
VVQ4000-19A-D is not included. (Order separately)  
Note 2) Drip proof type for F kit is not available.

D side end plate assembly part no. (For input/output type for S kit)

VVQ4000-3A-12

\* With connector on the SI unit

## <Manifold Block Assembly>

3. Manifold block assembly part no.

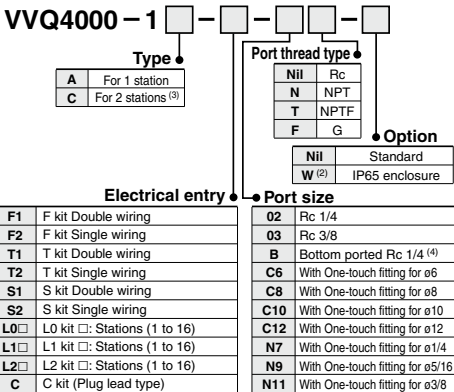

Note 1) Tie-rods (2 pcs.) and lead wire assembly for station addition included.  
Note 2) Dripproof F kit is not available.  
Note 3) When ordering block assembly for L kit 2 stations, the lead wire should be ordered by the smaller numbers of the D side (no. of station).  
Note 4) Bottom ported type: For 1-station type only.

8. Tie-rods part no. (2 pcs.)

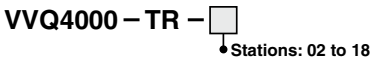

Note) When eliminating manifold stations, order this separately. When increasing manifold stations, it is not necessary to order since tie-rods are included in the manifold block assembly.

## <SI Unit>

SI Unit Part No.

Type	Model symbol	SI unit part no.	Description
Dedicated output model	O	—	Without SI unit
	F1	EX123 $\frac{3}{8}$ -SUW1	16 output points Fieldbus System (NKE)
	H	EX123 $\frac{3}{8}$ -SUH1	SI unit for 16 output points Fieldbus H System (NKE)
	J1	EX123 $\frac{3}{8}$ -SSL1	16 output points S-LINK System (Panasonic Industrial Devices SUNX Co., Ltd.)
	J2	EX123 $\frac{3}{8}$ -SSL2	8 output points S-LINK System (Panasonic Industrial Devices SUNX Co., Ltd.)
	Q	EX124 $\frac{3}{8}$ -SDN1	SI unit for DeviceNet (2 power supply systems)
	R1	EX124 $\frac{3}{8}$ -SCS1	SI unit for 16 output points CompoBus/S (2 power supply systems) (OMRON)
	R2	EX124 $\frac{3}{8}$ -SCS2	SI unit for 8 output points CompoBus/S (2 power supply systems) (OMRON)
	V	EX124 $\frac{3}{8}$ -SMJ1	SI unit for CC-LINK System (2 power supply systems)

## <U Side End Plate Assembly Part No.>

2. U side end plate assembly no. (For F, L, S, T kit)

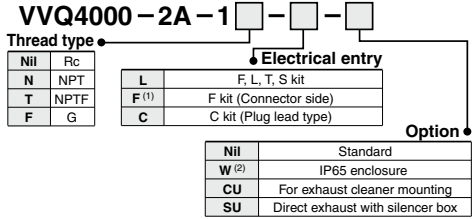

Note 1) D-sub connector assembly for D side:  
VVQ4000-19A-D is not included. (Order separately)  
Note 2) Drip proof type for F kit is not available.

U side end plate assembly part no. (For input/output type for S kit)

VVQ4000-2A-12

\* With connector on the SI unit

## <Manifold Block Replacement Parts>

Replacement Parts

No.	Part no.	Description	Material	Number
4	VVQ4000-80A-1	Gasket	HNBR	10
5	VVQ4000-80A-2	Gasket	HNBR	10
6	VVQ4000-80A-4	Clip	Stainless steel	10

Note) Spare parts consist of sets containing 10 pcs. each.

## <Fitting Assembly>

7. Fitting assembly part no. (For cylinder port)

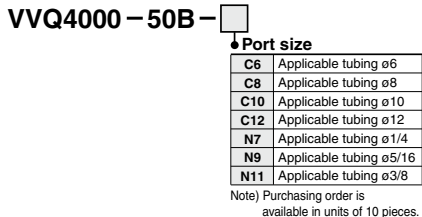

## <D-sub connector assembly>

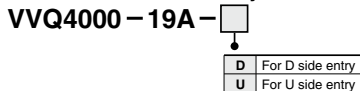

SJ  
SY  
SY  
SV  
SYJ  
SZ  
VF  
VP4  
S0700  
VQ  
VQ4  
VQ5  
VQC  
VQC4  
VQZ  
SQ  
VFS  
VFR  
VQ7

## List of Valves, Options, and Mounting Bolts

Number of options	Valve and options	Bolt part no.	Qty (pcs.)	Note	Option mounting diagram
0	Single valve	AXT632-17-4 (M3 x 37)	3		
	Blanking plate (VVQ4000-10A- $\frac{1}{2}$ )	AXT632-38-1 (M3 x 14)	4	For manifold	
1	Valve + Individual SUP spacer (VVQ4000-P- $\frac{1}{2}$ - $\frac{1}{2}$ )	① AXT632-17-10(M3 x 62) ② AXT632-17-19(M3 x 26)	3 2	For manifold	
	Valve + Individual EXH spacer (VVQ4000-R- $\frac{1}{2}$ - $\frac{1}{2}$ )	① AXT632-17-10(M3 x 62) ② AXT632-17-19(M3 x 26)	3 2	For manifold	
	Valve + Throttle valve spacer (VVQ4000-20A- $\frac{1}{2}$ )	① AXT632-17-10(M3 x 62) ② AXT632-17-19(M3 x 26)	3 2	Not necessary when mounting the sub-plate.	
	Valve + Release valve spacer (VVQ4000-R- $\frac{1}{2}$ - $\frac{1}{2}$ )	① AXT632-17-10(M3 x 62) ② AXT632-17-19(M3 x 26)	3 2	For manifold	
	Valve + SUP stop valve spacer (VVQ4000-37A- $\frac{1}{2}$ )	① AXT632-17-10(M3 x 62) ② AXT632-17-19(M3 x 26)	3 2	Not necessary when mounting the sub-plate.	
	Valve + Double check spacer with residual pressure release valve (VVQ4000-25A- $\frac{1}{2}$ )	① AXT632-17-11(M3 x 87) ② AXT632-41-1(M3 x 54)	3 2	Not necessary when mounting the sub-plate.	
	Valve + Interface regulator (ARBQ4000-00 $\frac{1}{2}$ - $\frac{1}{2}$ )	① AXT632-17-11(M3 x 87) ② AXT632-17-8(M3 x 52)	3 2	Not necessary when mounting the sub-plate.	
	Blanking plate + SUP stop valve (Top) (Bottom)	① AXT632-41-4(M3 x 42) ② AXT632-17-19(M3 x 26)	3 2	For manifold	
	2	Valve + Individual SUP + Individual EXH (Top) (Bottom) (Bottom) (Top)	① AXT632-17-11(M3 x 87) ② AXT632-17-8(M3 x 52)	3 2	
Valve + Throttle valve + Individual SUP or Individual EXH (Top) (Bottom) (Top) (Bottom)		① AXT632-17-11(M3 x 87) ② AXT632-17-8(M3 x 52)	3 2	For manifold The individual EXH cannot be mounted on the top.	
Valve + SUP stop valve + Individual SUP, Individual EXH or Throttle valve(Bottom)		① AXT632-17-11(M3 x 87) ② AXT632-17-8(M3 x 52)	3 2	For manifold	
Valve + Double check spacer with residual pressure release valve (Top) (Bottom) + Individual SUP or Individual EXH (Top) (Bottom)		① AXT632-17-14(M3 x 112) ② AXT632-41-2(M3 x 78)	3 2	For manifold	
Valve + Interface regulator + Individual SUP, Individual EXH or Throttle valve (Top) (Bottom)		① AXT632-17-14(M3 x 112) ② AXT632-41-2(M3 x 78)	3 2	For manifold The individual EXH and throttle valve can be mounted on the top.	
Valve + Throttle valve + Double check spacer with residual pressure release valve (Top) (Bottom)		① AXT632-17-14(M3 x 112) ② AXT632-41-2(M3 x 78)	3 2	For manifold	
Valve + Double check spacer with residual pressure release valve (Bottom) + Interface regulator (Top)		① AXT632-17-16(M3 x 137) ② AXT632-41-3(M3 x 103)	3 2	For manifold	
Blanking plate + SUP stop valve + Individual SUP (Top) (Bottom)	① AXT632-17-17(M3 x 66) ② AXT632-17-8(M3 x 52)	3 2	For manifold		
3	Valve + SUP stop valve (Top) + Individual SUP (Middle, Bottom) + Individual EXH (Middle, Bottom)	① AXT632-17-14(M3 x 112) ② AXT632-17-13(M3 x 77)	3 2	For manifold	
	Valve + Double check spacer with residual pressure release valve (Top) + Individual SUP (Middle, Bottom) + Individual EXH (Middle, Bottom)	① AXT632-17-16(M3 x 137) ② AXT632-41-3(M3 x 103)	3 2	For manifold	
	Valve + Spacer (Top); Interface regulator Spacer (Middle); Individual SUP or Individual EXH/Throttle valve Spacer (Bottom); Throttle valve/Individual SUP or Individual EXH	① AXT632-17-16(M3 x 137) ② AXT632-41-3(M3 x 103)	3 2	For manifold The individual EXH and throttle valve can be mounted on the top.	
	Valve + Double check spacer with residual pressure release valve (Top) + SUP stop valve (Middle) + Individual SUP (EXH) (Bottom)	① AXT632-17-16(M3 x 137) ② AXT632-41-3(M3 x 103)	3 2	For manifold	
	Valve + Interface regulator + Double check spacer with residual pressure release valve (Middle) + Individual SUP (EXH) (Bottom)	① AXT632-17-20(M3 x 162) ② AXT632-41-5(M3 x 128)	3 2	For manifold available as special order	

Note 1) When the SUP stop valve and individual SUP are mounted, the stop valve is mounted on the top of the individual SUP.



# Series VQ4000

## Specific Product Precautions 1

Be sure to read before handling.

Refer to front matter 53 for Safety Instructions and pages 3 to 8 for 3/4/5 Port Solenoid Valve Precautions.

### Manual Override Operation

#### Warning

Since connected equipment will be actuated when the manual override is operated, first confirm that conditions are safe. Non-locking push type (tool required) is standard. As a semi-standard specification, slotted locking type (tool required) is available.

#### Push type (Tool required)

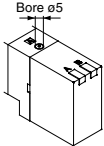

Push down on the manual override button with a small screwdriver until it stops. Release the screwdriver and the manual override will return.

#### Locking type (Tool required) <Semi-standard>

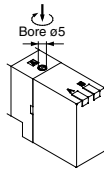

Push down completely on the manual override button with a small screwdriver. While down, turn clockwise 90° to lock it. Turn it counterclockwise to release it.

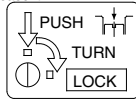

### Mounting of Valves

#### Caution

After confirming the gasket is correctly placed under the valve, securely tighten the bolts with the proper torque shown in the table below.

Proper tightening torque
0.8 to 1.2

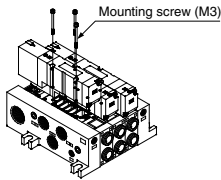

### Changing the One-touch Fittings

#### Caution

The built-in One-touch fittings on the cylinder port side are easily replaceable because of the cassette type. Clip prevents the fittings to come off. After removing the corresponding valve and take out the clip with a screwdriver, etc., then replace the fittings. About mounting the fittings, after inserting the fitting until it stops, then put the clip into the prescribed position.

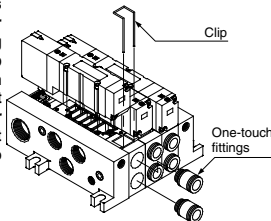

### Lead Wire Connection

#### Caution

##### Plug-in sub-plate (With terminal block)

- If the junction cover (1) of the sub-plate is removed, you can see the plug-in type terminal block (2) mounted inside the sub-plate.

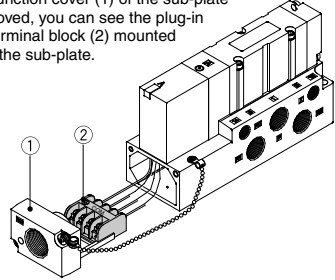

- The terminal block is marked as follows. Connect wiring to each of the power supply terminals.

Model	Terminal block marking	A	COM	B	⎓
VQ410 <sup>0</sup>	A side	COM	—	—	—
VQ420 <sup>1</sup>	A side	COM	B side	—	—
VQ4 <sup>3</sup> / <sub>0</sub>	A side	COM	B side	—	—

Note 1) There is no polarity. It can also be used as -COM.

Note 2) Double wiring is used on sub-plate VQ410<sup>1</sup>.

- Applicable terminal 1.25-3S, 1.25Y-3, 1.25Y-3N, 1.25Y-3.5

#### Plug lead: Grommet type

Make connections to each corresponding wire.

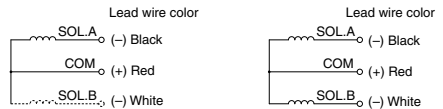

Single solenoid

Double solenoid

	Single solenoid	Double solenoid
Standard	Black: A side solenoid Red: COM	Black: A side solenoid Red: COM White: B side solenoid
Enclosure IP65 compliant	Black: A side solenoid Red: COM	Black: A side solenoid Red: COM White: B side solenoid (Not used for single solenoid)

Note) There is no polarity. It can also be used as -COM.

SJ  
SY  
SY  
SV  
SYJ  
SZ  
VF  
VP4  
S0700  
VQ  
VQ4  
VQ5  
VQC  
VQC4  
VQZ  
SQ  
VFS  
VFR  
VQ7



# Series VQ4000

## Specific Product Precautions 2

Be sure to read before handling.

Refer to front matter 53 for Safety Instructions and pages 3 to 8 for 3/4/5 Port Solenoid Valve Precautions.

### Installation and Removal of Light Cover

#### ⚠ Caution

##### Installation/Removal of light cover

###### ● Removal

Open the cover by inserting a small flat head screwdriver into the slot on the side of the pilot assembly (see drawing below), lift the cover out about 1 mm and then pull off. If it is pulled off at an angle, the pilot valve may be damaged or the protective O-ring may be scratched.

###### ● Installation

Place the cover straight over the pilot assembly so that the pilot valve is not touched, and push it until the cover hook locks without twisting the protective O-ring. (When pushed in, the hook opens and locks automatically.)

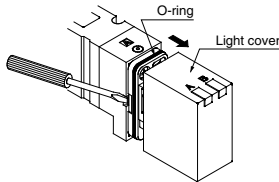

### Replacement of Pilot Valve

#### ⚠ Caution

###### ● Removal

1) Remove the mounting screw that holds the pilot valve using a small screwdriver.

###### ● Installation

1) After confirming the gasket is correctly placed under the valve, securely tighten the bolts with the proper torque shown in the table below.

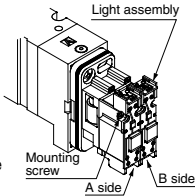

#### Proper tightening torque (N·m)

0.1 to 0.13

Note) The light circuit boards: A side is orange and the B side is green. It must be mounted on the pilot valve in accordance with the mounting indicators.

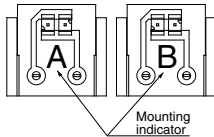

### For Plug Lead Type

#### Attaching and detaching connectors

● To attach a connector, hold the lever and connector unit between your fingers and insert straight into the pins of the solenoid valve so that the lever's pawl is pushed into the groove and locks.

● To detach a connector, remove the pawl from the groove by pushing the lever downward with your thumb, and pull the connector straight out.

Note) Do not pull on the lead wires with excessive force. This can cause faulty and/or broken contacts.

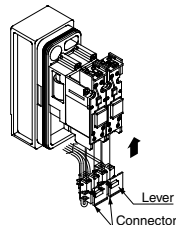

### Internal Wiring Specifications

#### ⚠ Caution

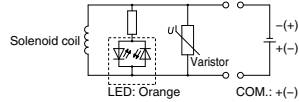

DC: Single

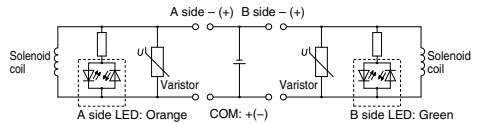

DC: Double

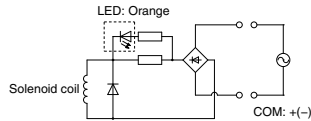

AC: Single

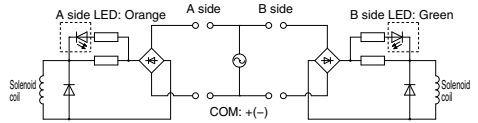

AC: Double

Note) For DC, coil surge voltage generated when OFF is about -60V. Contact SMC separately for further suppression of the coil surge voltage.

### Enclosure IP65

#### ⚠ Caution

Wires, cables, connectors, etc. used for models conforming to IP65 should also have enclosures equivalent to or stricter rating than IP65.

### How to Calculate the Flow Rate

For obtaining the flow rate, refer to front matters 42 to 45.

#### ■ Trademark Information

DeviceNet™ is a trademark of ODVA.

# 5 Port Solenoid Valve

## Series VQ5000

**Metal Seal**

**Rubber Seal**

### Space-saving profile

Clean space saving design with all pilot valves concentrated to one side with no protrusions in any direction

Space-saving — 40% less

Capacity-saving — 50% less

(In-house comparison)

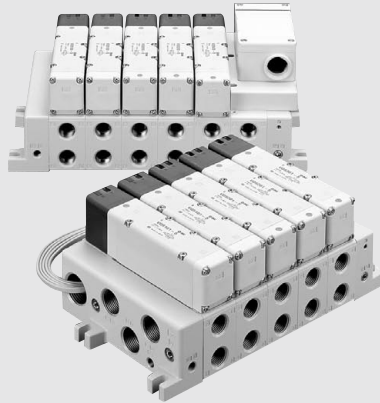

### Compact with large flow capacity

(Ideal for driving cylinders up to  $\phi 180$ )

### Enclosure IP65 compliant Dust tight/Low jetproof type

### Outstanding response times and long service life

(Metal seal with light/surge suppressor)

VQ5100 (Single)	32 mS	} 100 million cycles * According to SMC life test conditions
VQ5200 (Double)	17 mS	
Accuracy	$\pm 3$ mS	

\* For applications which demand high speed, high frequency, long life and a precise response time.

### A variety of common wiring methods are standardized.

<Plug-in type>

**F** kit (D-sub connector)  
P.1116

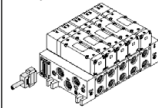

**L** kit (Lead wire)  
P.1128

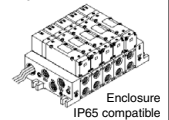

**T** kit (With individual terminal blocks)  
P.1120

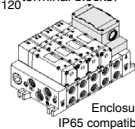

**S** kit (Serial transmission)  
P.1132

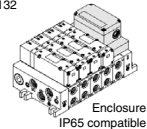

**T1** kit (Terminal block box)  
P.1124

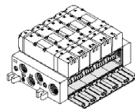

● 5 wiring types have been standardized to facilitate easy wiring work and maintenance. In addition, 3 of the wiring types are available with IP65 enclosures.

### Cylinder Speed Chart

Use as a guide for selection. Please confirm the actual conditions with SMC Sizing Program.

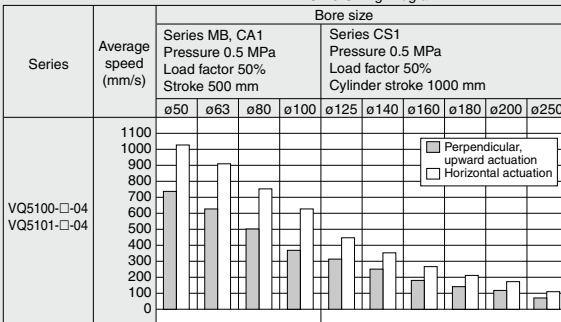

\* It is when the cylinder is extending that is meter-out controlled by speed controller which is directly connected with cylinder, and its needle valve with being fully open.  
 \* The average velocity of the cylinder is what the stroke is divided by the total stroke time.  
 \* Load factor: ((Load weight x 9.8)/Theoretical force) x 100%

#### System Components

Speed controller	Silencer	SGP (Steel pipe) dia. x Length
AS420-04	AN40-04	10A x 1 m

### Individual wiring type <Plug lead type>

**C** kit (Connector)  
P.1138

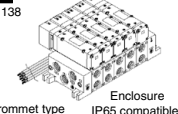

- SJ
- SY
- SY
- SV
- SYJ
- SZ
- VF
- VP4
- S0700
- VQ
- VQ4
- VQ5
- VQC
- VQC4
- VQZ
- SQ
- VFS
- VFR
- VQ7

# Base Mounted Plug-in/Plug Lead: Single Unit Series VQ5000

## Model

Series	Number of solenoids		Model		Port size	Flow Characteristics						Response time (ms)			Weight (kg)
						1 → 4/2(P → A/B)			4/2 → 5/3(A/B → EA/EB)			Standard 1W	Low wattage 0.5W	AC	
						C <sub>v</sub> (m <sup>3</sup> /s/bar)	b	C <sub>v</sub>	C <sub>v</sub> (m <sup>3</sup> /s/bar)	b	C <sub>v</sub>				
VQ5000	2 position	Single	Metal seal	VQ51 <sup>0</sup> <sub>5</sub> 0	Rc 1/2	12	0.14	2.9	14	0.18	3.4	35 or less	38 or less	38 or less	0.59(0.67)
			Rubber seal	VQ51 <sup>0</sup> <sub>5</sub> 1		16	0.33	4.4	17	0.31	4.7	40 or less	43 or less	43 or less	0.58(0.66)
		Double	Metal seal	VQ52 <sup>0</sup> <sub>5</sub> 0		12	0.14	2.9	14	0.18	3.4	20 or less	23 or less	23 or less	0.62(0.70)
			Rubber seal	VQ52 <sup>0</sup> <sub>5</sub> 1		16	0.33	4.4	17	0.31	4.7	25 or less	28 or less	28 or less	0.60(0.68)
	3 position	Closed center	Metal seal	VQ53 <sup>0</sup> <sub>5</sub> 0		11	0.24	2.6	11	0.23	2.8	50 or less	53 or less	53 or less	0.65(0.73)
			Rubber seal	VQ53 <sup>0</sup> <sub>5</sub> 1		12	0.33	3.4	13	0.37	3.7	60 or less	63 or less	63 or less	0.58(0.66)
		Exhaust center	Metal seal	VQ54 <sup>0</sup> <sub>5</sub> 0		12	0.13	2.9	14	0.18	3.4	50 or less	53 or less	53 or less	0.65(0.73)
			Rubber seal	VQ54 <sup>0</sup> <sub>5</sub> 1		14	0.39	3.9	16	0.35	4.5	60 or less	63 or less	63 or less	0.58(0.66)
		Pressure center	Metal seal	VQ55 <sup>0</sup> <sub>5</sub> 0		12	0.23	2.9	13	0.24	3.3	50 or less	53 or less	53 or less	0.65(0.73)
			Rubber seal	VQ55 <sup>0</sup> <sub>5</sub> 1		13	0.32	3.4	14	0.40	3.9	60 or less	63 or less	63 or less	0.58(0.66)
		Double check	Metal seal	VQ56 <sup>0</sup> <sub>5</sub> 0		8.0	—	—	8.5	—	—	62 or less	65 or less	65 or less	1.17(1.25)
			Rubber seal	VQ56 <sup>0</sup> <sub>5</sub> 1		8.3	—	—	9.0	—	—	75 or less	78 or less	78 or less	1.10(1.18)

Note 1) Value for valve on sub-plate.

Note 2) Cylinder port Rc 1/2: Value for valve on sub-plate.

Note 3) Based on JISB8375-1981. (Supply pressure: 0.5 MPa (5.1 kgf/cm<sup>2</sup>), with indicator light and surge voltage suppressor, clean air. This will change depending on pressure and air quality.) The value when ON for the double type.

Note 4) Values inside ( ) indicate the weight of plug lead units.

Table: Without sub-plate, With sub-plate; Add 0.65 kg for plug-in type, 0.55 kg for plug lead type.

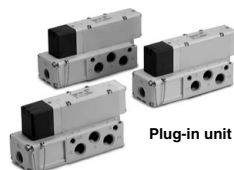

Plug-in unit



Plug lead unit

## Symbol

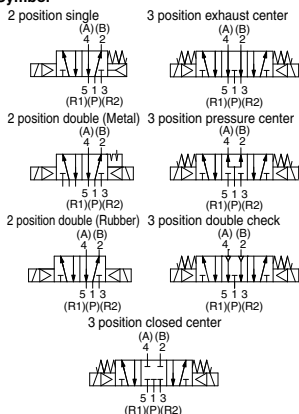

## Standard Specifications

Valve construction	Metal seal	Rubber seal
	Air	
Fluid	Air	
Maximum operating pressure <sup>(3)</sup>	1.0 MPa (0.7 MPa)	
Min. operating pressure	Single	0.10 MPa
	Double	0.10 MPa
	3 position	0.15 MPa
Proof pressure	1.5 MPa	
Ambient and fluid temperature	-5 to 50°C <sup>(1)</sup>	
Lubrication	Not required	
Manual override	Push type/Locking type (Tool required) Option	
Impact/Vibration resistance	150/30 m/s <sup>2</sup> <sup>(2)</sup>	
Protection structure	Dust tight (IP65 compatible)	
Coil rated voltage	12, 24 VDC, 100, 110, 200, 220 VAC (50/60 Hz)	
Allowable voltage fluctuation	±10% of rated voltage	
Coil insulation type	Class B or equivalent	
Power consumption (Current)	24 VDC	1 W DC (42 mA), 0.5 W DC (21 mA) <sup>(3)</sup>
	12 VDC	1 W DC (83 mA), 0.5 W DC (42 mA) Note <sup>(3)</sup>
	100 VAC	Inrush 1.2 VA (12 mA), Holding 1.2 VA (12 mA)
	110 VAC	Inrush 1.3 VA (11.7 mA), Holding 1.3 VA (11.7 mA)
	200 VAC	Inrush 2.4 VA (12 mA), Holding 2.4 VA (12 mA)
220 VAC	Inrush 2.6 VA (11.7 mA), Holding 2.6 VA (11.7 mA)	

Note 1) Use dry air to prevent condensation when operating at low temperatures.

Note 2) Impact resistance: No malfunction occurred when it is tested with a drop tester in the axial direction and at the right angles to the main valve and armature in both energized and de-energized states every once for each condition. (Values at the initial period)

Vibration resistance: No malfunction occurred in a one-sweep test between 45 and 2000 Hz. Test was performed at both energized and de-energized states in the axial direction and at the right angles to the main valve and armature. (Values at the initial period)

Note 3) Values inside ( ) denote the low wattage (0.5 W) specifications.



# Series VQ5000

## Plug-in Type

### Conduit terminal

#### 2 position single: VQ510<sup>0</sup>

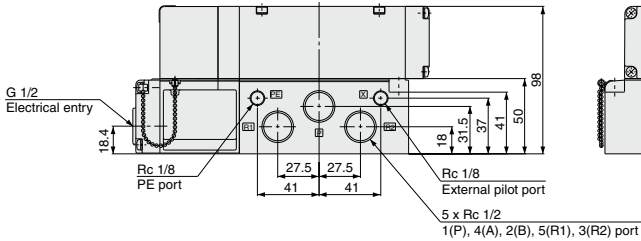
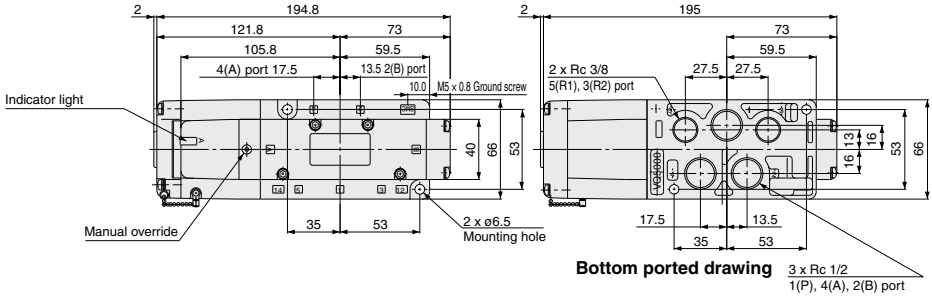

#### 2 position double: VQ520<sup>0</sup>

#### 3 position closed center: VQ530<sup>0</sup>

#### 3 position exhaust center: VQ540<sup>0</sup>

#### 3 position pressure center: VQ550<sup>0</sup>

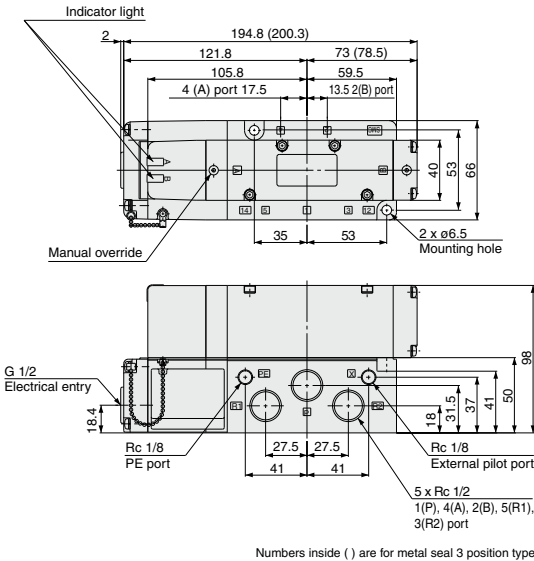

#### 3 position double check: VQ560<sup>0</sup>

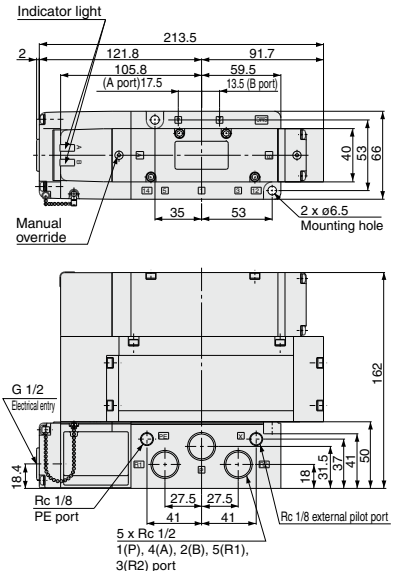



**Plug Lead Type**

**Grommet**

**2 position single: VQ515<sup>0</sup>-□<sub>G</sub>H**

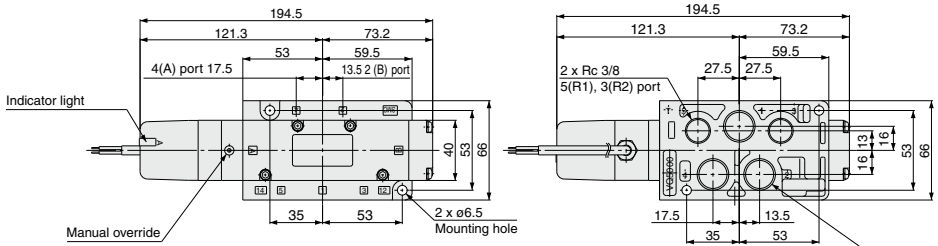

**Bottom ported drawing** 3 x Rc 1/2  
1(P), 4 (A), 2 (B) port

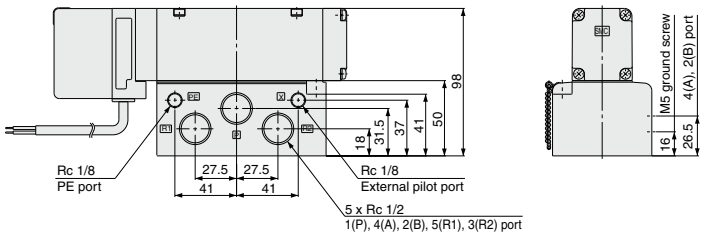

**2 position double: VQ525<sup>0</sup>-□<sub>G</sub>H**  
**3 position closed center: VQ535<sup>0</sup>-□<sub>G</sub>H**  
**3 position exhaust center: VQ545<sup>0</sup>-□<sub>G</sub>H**  
**3 position pressure center: VQ555<sup>0</sup>-□<sub>G</sub>H**

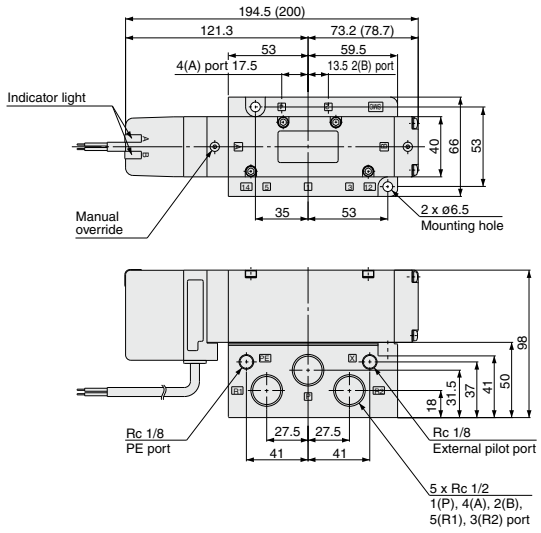

**3 position double check: VQ565<sup>0</sup>-□<sub>G</sub>H**

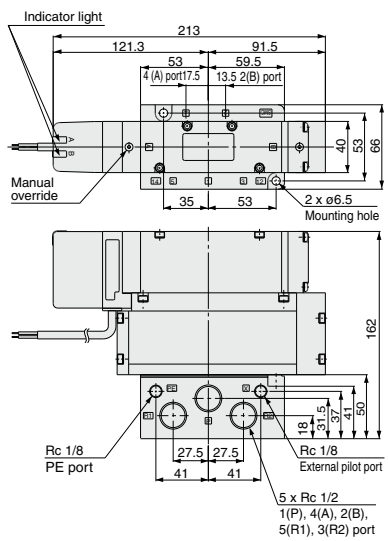

Numbers inside ( ) are for metal seal 3 position type

SJ
SY
SY
SV
SYJ
SZ
VF
VP4
S0700
VQ
VQ4
<b>VQ5</b>
VQC
VQC4
VQZ
SQ
VFS
VFR
VQ7

# Base Mounted Plug-in Unit



# Series VQ5000



## How to Order Manifold

VV5Q 5 1 - 08 03 F U1 - -

**Series**

5	VQ5000
---	--------

**Manifold**

1	Plug-in Unit
---	--------------

**Station**

01	1 station
:	:
:	:

Minimum number of stations depends on the kit.  
(Refer to the table below.)

**Cylinder port**

03	Rc 3/8
04	Rc 1/2
B	Bottom ported Rc 1/2
CM	Mixed (Note)

Note) In case of mixed specification, indicate on the manifold specification sheet.

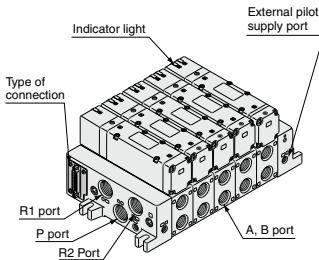

Note) The drawing shows a VV5Q51-0504FD0.

**Option**

Symbol	Option
Nll	None
CD1 <sup>(2)</sup>	Exhaust cleaner for Rc 1: D side exhaust
CD2 <sup>(2)</sup>	Exhaust cleaner for Rc 1 1/2: D side exhaust
CU1 <sup>(2)</sup>	Exhaust cleaner for Rc 1: U side exhaust
CU2 <sup>(2)</sup>	Exhaust cleaner for Rc 1 1/2: U side exhaust
K <sup>(4)</sup>	Special wiring specifications (Except double wiring)
N	Name plate (T kit only)
SB <sup>(3)</sup>	Direct exhaust with silencer box: Exhaust from both D and U sides
SD <sup>(2)</sup>	Direct exhaust with silencer box: D side exhaust
SU <sup>(2)</sup>	Direct exhaust with silencer box: U side exhaust
W	IP65 enclosure (except F and T1 kits)

**CE-compliant**

Nll	—
Q	CE-compliant

Note 1) When two or more symbols are specified, indicate them alphabetically. Example) -CD12

Note 2) Combination of [CD] and [SU] is not possible.

Note 3) Available only with F, L and T1 kits.

Note 4) Specify the wiring specifications on the manifold specification sheet. (Except L kit)

### Kit/Electrical entry/Cable length

#### F kit (D-sub connector)

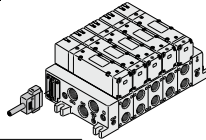

Connector entry direction					
D side	U side				
Kit D0	Kit U0	Without cable		1 to 12 stations	
Kit D1	Kit U1	Cable length 1.5 m			
Kit D2	Kit U2	Cable length 3 m			
Kit D3	Kit U3	Cable length 5 m			

#### L kit (Lead wire cable)

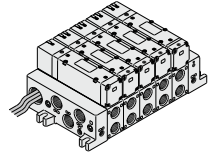

Connector entry direction				IP65 compatible	
D side	U side				
Kit D0	Kit U0	Cable length 0.6 m		1 to 12 stations	
Kit D1	Kit U1	Cable length 1.5 m			
Kit D2	Kit U2	Cable length 3 m			

#### T kit (Terminal block box kit)

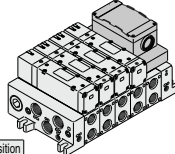

Box mounting position		IP65 compatible	
D side	U side		
Kit TD	Kit TU	Terminal block box	2 to 12 stations

#### S kit (Serial transmission unit)

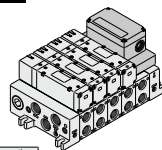

The valve voltage is 24 VDC and it is equipped with light/surge voltage suppressor.

Unit mounting position		IP65 compatible	
D side	U side		CE-compliant
0	Without SI unit	—	●

#### T1 kit (Individual terminal block kit)

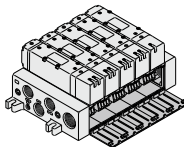

Box mounting position		IP65 compatible	
D side	U side		
Kit T1	With terminal blocks		1 to 12 stations

Unit mounting position		IP65 compatible	
D side	U side		CE-compliant
SD	SU		
F1	NKE Corp.: Fieldbus System	—	●
H	NKE Corp.: Fieldbus H System	—	—
J1	Panasonic Industrial Devices SUNX Co., Ltd.: S-LINK (16 output points)	—	—
J2	Panasonic Industrial Devices SUNX Co., Ltd.: S-LINK (8 output points)	—	—
Q	DeviceNet	●	—
R1	OMRON Corp.: CompoBus/S (16 output points)	●	—
R2	OMRON Corp.: CompoBus/S (8 output points)	●	—
V	CC-LINK System	●	—

Note) 2 to 12 stations

Note) For the T kit and S kit, one station is required to mount the terminal block box or SI unit, so the minimum number of stations is 2 stations.

## Manifold Specifications

Series	Base model	Type of connection	Porting specifications			Maximum applicable stations	Applicable solenoid valve	Weight (kg) (Formula)
			4(A), 2(B) port location	Port size <small>(Note)</small>				
				1(P), 5(R1), 3(R2)	4(A), 2(B)			
VQ5000	VV5Q51-□□□	<ul style="list-style-type: none"> <li>■ F kit—D-sub connector</li> <li>■ T kit—Terminal block box</li> <li>■ T1 kit—Individual terminal block kit</li> <li>■ L kit—Lead wire</li> <li>■ S kit—Serial transmission</li> </ul>	Side	Rc 3/4 Option (Direct exhaust with silencer box)	Rc 3/8 Rc 1/2	F, L, T1 kits 12 stations  T kit 12 stations  S kit 12 stations	VQ5□00 VQ5□01	F, L Kit: 0.62n+1.4 S, T Kit: 0.62(n-1)+2.6  • Not including solenoid valve mass.
			Bottom		Rc 1/2			

Note) For details about international standard threads other than Rc threads, refer to "Option" on page 1145.

n: Stations

## Flow Characteristics at the Number of Manifold Stations (Operated individually)

Model	Passage/Stations		Station 1	Station 5	Station 10
2 position metal seal VQ5 <sub>2</sub> 00	1 → 4/2(P → A/B)	C [dm <sup>3</sup> /(s·bar)]	11	11	11
		b	0.24	0.24	0.24
		Cv	2.7	2.7	2.7
	4/2 → 5/3(A/B → EA/EB)	C [dm <sup>3</sup> /(s·bar)]	12	12	12
		b	0.14	0.14	0.14
		Cv	2.9	2.9	2.9
2 position rubber seal VQ5 <sub>2</sub> 01	1 → 4/2(P → A/B)	C [dm <sup>3</sup> /(s·bar)]	12	12	12
		b	0.33	0.33	0.33
		Cv	3.4	3.4	3.4
	4/2 → 5/3(A/B → EA/EB)	C [dm <sup>3</sup> /(s·bar)]	16	16	16
		b	0.33	0.33	0.33
		Cv	4.4	4.4	4.4

Note) For port size Rc 1/2

## Manifold Options

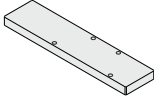
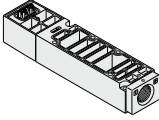
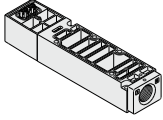
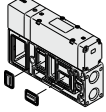
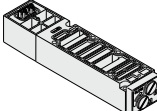
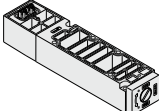
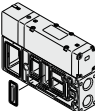
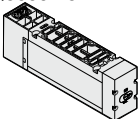
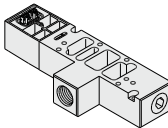
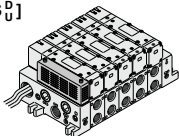
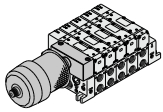
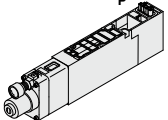
<b>Blanking plate assembly</b> <b>VVQ5000-10A-1</b> 	<b>Individual SUP spacer</b> <b>VVQ5000-P-1-<sup>03</sup>/<sub>04</sub></b> 	<b>Individual EXH spacer</b> <b>VVQ5000-R-1-<sup>03</sup>/<sub>04</sub></b> 	<b>EXH block plate</b> <b>VVQ5000-16A-2</b> 
<b>Throttle valve spacer</b> <b>VVQ5000-20A-1</b> 	<b>SUP stop valve spacer</b> <b>VVQ5000-37A-1</b> 	<b>SUP block plate</b> <b>VVQ5000-16A-1</b> 	<b>Double check spacer with residual pressure release valve</b> <b>VVQ5000-25A-1</b> 
<b>Release valve spacer</b> <b>VVQ5000-24A-1D</b> 	<b>Direct exhaust with silencer box</b> <b>[-S<sub>0</sub>□]</b> 	<b>For exhaust cleaner mounting</b> <b>[-C<sub>0</sub>□]</b> 	<b>Interface regulator</b> <b>ARBQ5000-00-<sup>A</sup>/<sub>B</sub>-1</b> 

• Refer to pages 1140 to 1144 for detailed dimensions of each option.  
 • For replacement parts, refer to page 1149.

SJ  
SY  
SY  
SV  
SYJ  
SZ  
VF  
VP4  
S0700  
VQ  
VQ4  
VQ5  
VQC  
VQC4  
VQZ  
SQ  
VFS  
VFR  
VQ7

# Series VQ5000

## F Kit (D-sub Connector kit)

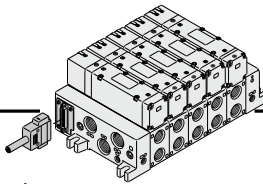

- Simplification and labor savings for wiring work can be achieved by using a D-sub connector for the electrical connection.
- Using connector for flat ribbon cable (25P) conforming to MIL standard permits the use of connectors put on the market and gives a wide interchangeability.
- Connector entry can be selected on either the U side or the D side according to the mounting orientation.
- Maximum stations are 12.

### Manifold Specifications

Series	Porting specifications 4(A), 2(B) port location	Port size		Applicable stations
		1(P), 5(R1), 3(R2)	4(A), 2(B)	
VQ5000	Side	Rc 3/4	Rc 3/8	Max. 12 stations
	Bottom		Rc 1/2	

### D-Sub Connector Kit (25Pins)

#### Cable assembly ●

AXT100-DS25-015  
030  
050

(D-sub connector cable assemblies can be ordered with manifolds.)  
Refer to How to Order Manifold.

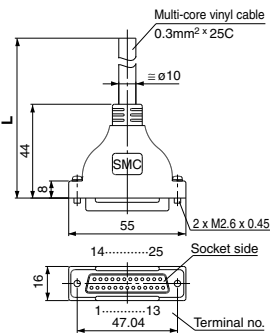

#### D-sub Connector Cable Assembly

Cable length (L)	Assembly part no.	Note
1.5 m	AXT100-DS25-015	Cable 25 cores x 24AWG
3 m	AXT100-DS25-030	
5 m	AXT100-DS25-050	

\* For other commercial connectors, use a 25 pins type with female connector conforming to MIL-C-24308.

\* Cannot be used for transfer wiring.

#### Connector manufacturers' example

- Fujitsu, Ltd.
- Japan Aviation Electronics Industry, Ltd.
- J.S.T. Mfg. Co., Ltd.
- Hirose Electric Co., Ltd.

#### Electric Characteristics

Item	Characteristics
Conductor resistance Ω/km, 20°C	65 or less
Voltage limit VAC, 1 min.	1000
Insulation resistance MΩkm, 20°C	5 or less

Note) The min. bending radius of D-sub cable is 20 mm.

#### D-sub Connector Cable Assembly Terminal No.

Terminal no.	Lead wire color	Dot marking
1	Black	None
2	Brown	None
3	Red	None
4	Orange	None
5	Yellow	None
6	Pink	None
7	Blue	None
8	Purple	White
9	Gray	Black
10	White	Black
11	White	Red
12	Yellow	Red
13	Orange	Red
14	Yellow	Black
15	Pink	Black
16	Blue	White
17	Purple	None
18	Gray	None
19	Orange	Black
20	Red	White
21	Brown	White
22	Pink	Red
23	Gray	Red
24	Black	White
25	White	None

Note) Lengths other than the above is also available. Please contact SMC for details.

### How to Order Manifold

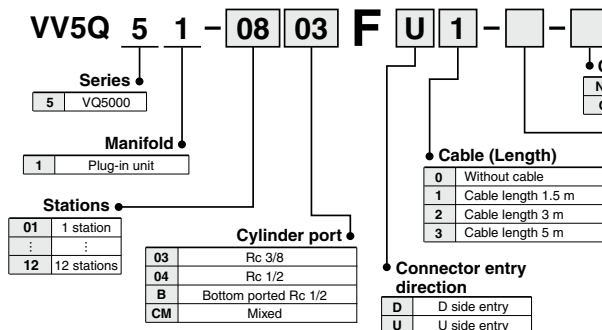

Stations ●

01	1 station
...	...
12	12 stations

Cylinder port ●

03	Rc 3/8
04	Rc 1/2
B	Bottom ported Rc 1/2
CM	Mixed

Cable (Length) ●

0	Without cable
1	Cable length 1.5 m
2	Cable length 3 m
3	Cable length 5 m

Connector entry direction ●

D	D side entry
U	U side entry

CE-compliant ●

Nil	—
Q	CE-compliant

#### Option

Symbol	Option
Nil	None
CD1	Exhaust cleaner for Rc 1: D side exhaust
CD2	Exhaust cleaner for Rc 1 1/2: D side exhaust
CU1	Exhaust cleaner for Rc 1: U side exhaust
CU2	Exhaust cleaner for Rc 1 1/2: U side exhaust
K <sup>(3)</sup>	Special wiring specifications (Except double wiring)
SB	Direct exhaust with silencer box: For mounting on both D and U sides
SD	Direct exhaust with silencer box: D side exhaust
SU	Direct exhaust with silencer box: U side exhaust

Note 1) When two or more symbols are specified, indicate them alphabetically. Example) -CD1K.

Note 2) Combination of [C] and [S] is not possible.

Note 3) Specify the wiring specifications on the manifold specification sheet.

## Electrical wiring specifications

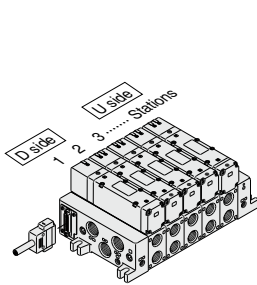

Stations are counted starting from the first station on the D side.

### D-sub connector

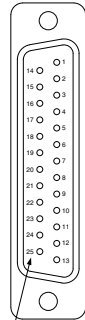

Double wiring (connected to SOL. A and SOL. B) is adopted for the internal wiring of each station, regardless of valve and option types. Mixed single and double wiring is available as a semi-standard specification. For details, refer to below.

### Standard wiring

Terminal no.	Polarity	Lead wire color	Dot marking
1 station { SOL.A 1	(-)	(+) Black	None
SOL.B 14	(-)	(+) Yellow	Black
2 stations { SOL.A 2	(-)	(+) Brown	None
SOL.B 15	(-)	(+) Pink	Black
3 stations { SOL.A 3	(-)	(+) Red	None
SOL.B 16	(-)	(+) Blue	White
4 stations { SOL.A 4	(-)	(+) Orange	None
SOL.B 17	(-)	(+) Purple	None
5 stations { SOL.A 5	(-)	(+) Yellow	None
SOL.B 18	(-)	(+) Gray	None
6 stations { SOL.A 6	(-)	(+) Pink	None
SOL.B 19	(-)	(+) Orange	Black
7 stations { SOL.A 7	(-)	(+) Blue	None
SOL.B 20	(-)	(+) Red	White
8 stations { SOL.A 8	(-)	(+) Purple	White
SOL.B 21	(-)	(+) Brown	White
9 stations { SOL.A 9	(-)	(+) Gray	Black
SOL.B 22	(-)	(+) Pink	Red
10 stations { SOL.A 10	(-)	(+) White	Black
SOL.B 23	(-)	(+) Gray	Red
11 stations { SOL.A 11	(-)	(+) White	Red
SOL.B 24	(-)	(+) Black	White
12 stations { SOL.A 12	(-)	(+) Yellow	Red
SOL.B 25	(-)	(+) White	None
COM. 13	(+)	(-) (Note) Orange	Red

Positive common specifications Negative common specifications

### D-sub connector assembly (AXT100-DS25-015/050) Wire colors

## Special Wiring Specifications

Double wiring (connected to SOL. A and SOL. B) is used for the internal wiring of each station regardless of valve and option types. Mixed single and double wiring is available as a semi-standard specification.

### 1. How to Order

Indicate option symbol "K" in the manifold part number and be sure to specify station positions for single or double wiring on the manifold specification sheet.

### 2. Wiring specifications

Connections begin with the A side solenoid of the first station being connected to terminal no. 1, and continue in the order indicated by the arrows in the drawing without skipping any terminals. However, the maximum number of stations is 12.

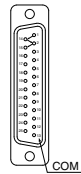

D-sub connector

## How to Order Valves

**VQ 5 1 0 0 - 5**

**Series**  
5 VQ5000

**Type of actuation**

1	2 position single
2	2 position double
3	3 position closed center
4	3 position exhaust center
5	3 position pressure center
6	3 position double check

**Seal**

0	Metal seal
1	Rubber seal

**Function**

Nil	Standard type (1 W)
Y <sup>(1)</sup>	Low wattage type (0.5 W)
R <sup>(2)</sup>	External pilot

**Light/Surge voltage suppressor**

Nil	Yes
E	Without light, with surge voltage suppressor

**Coil voltage**

1	100 VAC (50/60 Hz)
2	200 VAC (50/60 Hz)
3	110 VAC (50/60 Hz)
4	220 VAC (50/60 Hz)
5	24 VDC
6	12 VDC

**Manual override**

Nil	Non-locking push type (Tool required)
B	Locking type (Tool required)

**CE-compliant**

Nil	—
Q	CE-compliant

Note 1) Applicable to DC specifications. Please select when you expect to energize the unit for extended periods of time. Refer to page 3 for details.

Note 2) Refer to page 1145 for details on external pilot specifications.

Note 3) When two or more symbols are specified, indicate them alphabetically.

## How to Order Manifold Assembly [Order example]

Specify the part numbers for valves and options together beneath the manifold base part number.

### <Example>

D-sub connector kit with cable (3 m)

VW5051-0503FD2(Q)-1 set - Manifold base part no.  
=VQ5100-5(-Q) ... 2 sets - Valve part no. (Stations 1 and 2)  
=VQ5200-5(-Q) ... 2 sets - Valve part no. (Stations 3 and 4)  
=VQ5300-5(-Q) ... 1 set - Valve part no. (Station 5)

Prefix the asterisk to the part nos. of the solenoid valve, etc.

Enter in order starting from the first station on the D side. When entry of part numbers becomes complicated, indicate in the manifold specification sheet.

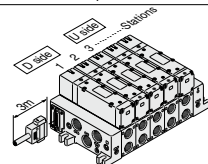

# Series VQ5000

**F**

## Kit (D-sub Connector kit)

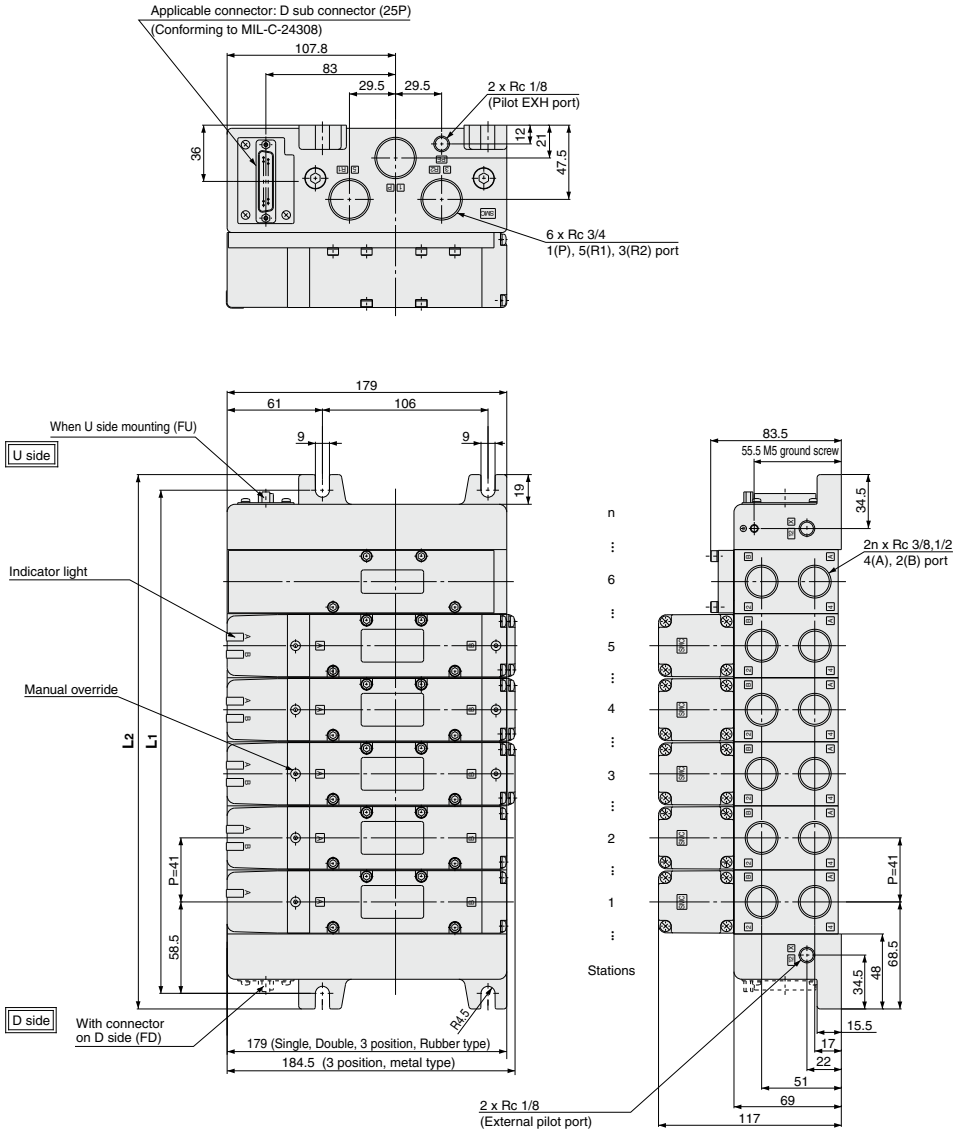

**Bottom ported drawing**

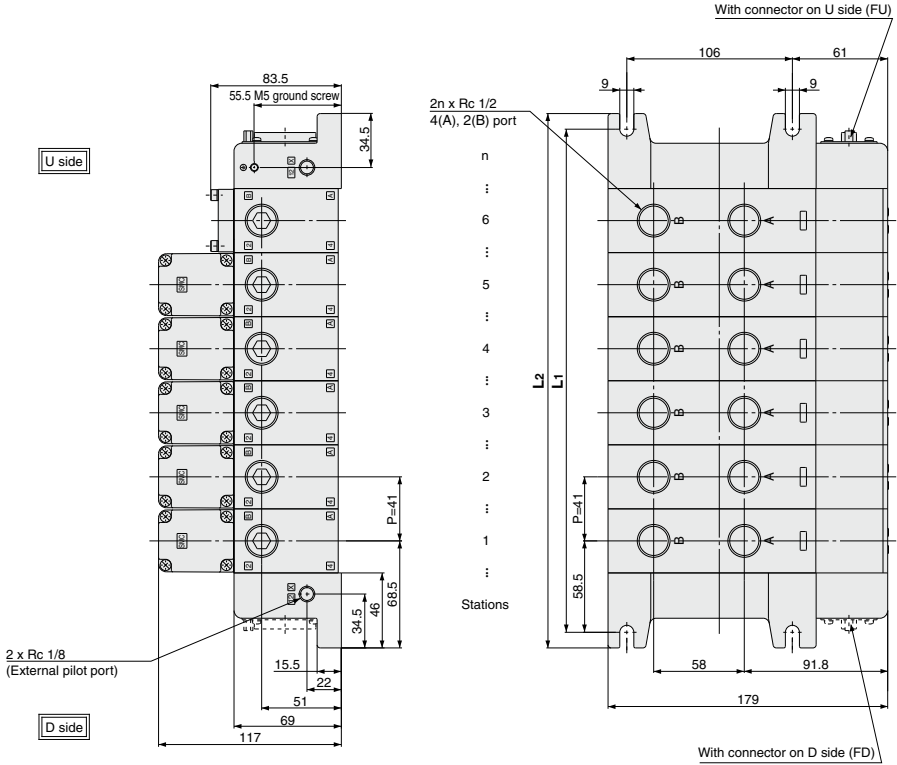

- SJ
- SY
- SY
- SV
- SYJ
- SZ
- VF
- VP4
- S0700
- VQ
- VQ4
- VQ5**
- VQC
- VQC4
- VQZ
- SQ
- VFS
- VFR
- VQ7

Formula:  $L1 = 41n + 76$ ,  $L2 = 41n + 96$   
 n: Stations (Maximum 12 stations)

**Dimensions**

L	n	1	2	3	4	5	6	7	8	9	10	11	12
L1		117	158	199	240	281	322	363	404	445	486	527	568
L2		137	178	219	260	301	342	383	424	465	506	547	588

# Series VQ5000

## T Kit (Terminal block box kit)

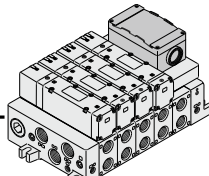

IP65 compliant

- Enclosure IP65 compliant
- This type has a small terminal block inside a junction box.  
The provision of a G 3/4 electrical entry allows connection of conduit fittings.
- Maximum stations are 11. (12 stations as an option)
- 1 station is used for terminal block box mounting.

### Manifold Specifications

Series	Porting specifications			Applicable stations
	4(A), 2(B) port location	Port size		
VQ5000		Side	1(P), 5(R1), 3(R2)	4(A), 2(B)
	Rc 3/4		Rc 3/8 Rc 1/2	
	Bottom		Rc 1/2	

### Terminal Block Connections

#### Step 1. How to remove terminal block cover

Loosen the 4 mounting screws (M4) and open the terminal block cover.

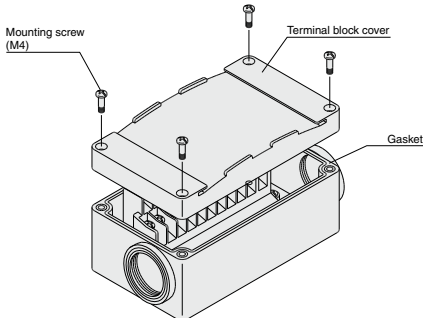

#### Step 2. The diagram on the right shows the terminal block wiring.

All stations are provided with double wiring regardless of the valves which are mounted.

Connect each wire to the power supply side, according to the markings provided inside the terminal block.

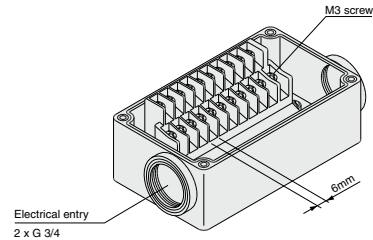

#### Step 3. How to attach the terminal block cover

Securely tighten the screws with the torque shown in the table below, after confirming that the gasket is installed correctly.

Proper tightening torque (N·m)
0.7 to 1.2

- Applicable terminal: 1.25-3s, 1.25Y-3, 1.25Y-3N, 1.25Y-3.5
- Name plate: VVQ5000-N-T
- Drip-proof plug assembly (for G 3/4): AXT100-B06A



### How to Order Manifold

VV5Q 5 1 - 08 03 T - K -

**Series**  
5 VQ5000

**Manifold**  
1 Plug-in unit

**Stations**

02	2 stations
...	...
12	12 stations

Note) One station is used for mounting the terminal block box. The number of stations is the number of manifold valves plus one station for the terminal block box. For 12 stations, specify the wiring specifications by means of the manifold specification sheet.

#### ● Cylinder port

03	Rc 3/8
04	Rc 1/2
B	Bottom ported Rc 1/2
CM	Mixed

#### ● Box mounting position

D	D side mounting
U	U side mounting

#### ● CE-compliant

Nil	—
Q	CE-compliant

#### ● Option

Symbol	Option
Nil	None
CD1 <sup>(2)</sup>	Exhaust cleaner for Rc 1: D side exhaust
CD2 <sup>(2)</sup>	Exhaust cleaner for Rc 1 1/2: D side exhaust
CU1 <sup>(2)</sup>	Exhaust cleaner for Rc 1: U side exhaust
CU2 <sup>(2)</sup>	Exhaust cleaner for Rc 1 1/2: U side exhaust
K <sup>(3)</sup>	Special wiring specification (Except double wiring), 12 stations
N	Name plate
SD <sup>(2)</sup>	Direct exhaust with silencer box: D side exhaust
SU <sup>(2)</sup>	Direct exhaust with silencer box: U side exhaust
W	IP65 enclosure

Note 1) When two or more symbols are specified, indicate them alphabetically.  
Example -CD1K.

Note 2) Combination of [C<sub>D</sub> □] and [S<sub>U</sub> □] is not possible.

Note 3) Specify the wiring specifications on the manifold specification sheet.



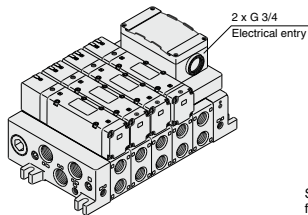

Stations are counted starting from the first station on the D side.

## Electrical wiring specifications (IP65 available)

**Standard wiring**

Terminal no.	Polarity
1 station SOLA 01A	(-) (+)
SOLB 01B	(-) (+)
2 stations SOLA 02A	(-) (+)
SOLB 02B	(-) (+)
3 stations SOLA 03A	(-) (+)
SOLB 03B	(-) (+)
4 stations SOLA 04A	(-) (+)
SOLB 04B	(-) (+)
5 stations SOLA 05A	(-) (+)
SOLB 05B	(-) (+)
6 stations SOLA 06A	(-) (+)
SOLB 06B	(-) (+)
7 stations SOLA 07A	(-) (+)
SOLB 07B	(-) (+)
8 stations SOLA 08A	(-) (+)
SOLB 08B	(-) (+)
9 stations SOLA 09A	(-) (+)
SOLB 09B	(-) (+)
10 stations SOLA 010A	(-) (+)
SOLB 010B	(-) (+)
SOLA 0COM	(-) (-)

Positive Negative  
common common

Double wiring (connected to SOLA and SOLB) is adopted for the internal wiring of each station, regardless of valve and option types. Mixed single and double wiring is available as a semi-standard specification.

## Special Wiring Specifications

Double wiring (connected to SOLA and SOLB) is used for the internal wiring of each station regardless of valve and option types. The optional specification permits mixture of single and double wiring. However, the maximum number of stations is 12.

### 1. How to Order

Indicate option symbol ("K") in the manifold part number and be sure to specify station positions for single or double wiring on the manifold specification sheet.

### 2. Wiring specifications

Connections begin with the A side solenoid of the first station being connected to terminal no. 1, and continue in the order indicated by the arrows in the drawing without skipping any terminals.

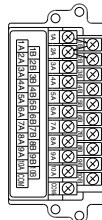

## How to Order Valves

**VQ 5 1 0 0** - 5

**Series**

5	VQ5000
---	--------

**Type of actuation**

1	2 position single
2	2 position double
3	3 position closed center
4	3 position exhaust center
5	3 position pressure center
6	3 position double check

**Seal**

0	Metal seal
1	Rubber seal

**Function**

Nil	Standard type (1 W)
Y (1)	Low wattage type (0.5 W)
R (2)	External pilot

**CE-compliant**

Nil	—
Q	CE-compliant

**Enclosure**

Nil	Dusttight
W	Dusttight/Low jetproof type (IP65)

**Manual override**

Nil	Non-locking push type (Tool required)
B	Locking type (Tool required)

**Light/Surge voltage suppressor**

Nil	Yes
E	Without light, with surge voltage suppressor

**Coil voltage**

1	100 VAC (50/60 Hz)
2	200 VAC (50/60 Hz)
3	110 VAC (50/60 Hz)
4	220 VAC (50/60 Hz)
5	24 VDC
6	12 VDC

Note 1) Applicable to DC specifications. Please select when you expect to energize the unit for extended periods of time. Refer to page 3 for details.

Note 2) Refer to page 1145 for details on external pilot specifications.

Note 3) When two or more symbols are specified, indicate them alphabetically.



[Option]

## How to Order Manifold Assembly [Order example]

Specify the part numbers for valves and options together beneath the manifold base part number.

### <Example>

Terminal block box kit

VV5051-0603TU(-Q) - 1 set — Manifold base part no.

+ VQ5100-5(-Q) .... 2 sets — Valve part no. (Stations 1 and 2)

+ VQ5200-5(-Q) .... 2 sets — Valve part no. (Stations 3 and 4)

+ VQ5300-5(-Q) ..... 1 set — Valve part no. (Station 5)

Prefix the asterisk to the part nos. of the solenoid valve, etc.

Enter in order starting from the first station on the D side. When entry of part numbers becomes complicated, indicate in the manifold specification sheet.

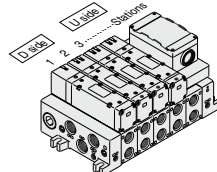

- SJ
- SY
- SY
- SV
- SYJ
- SZ
- VF
- VP4
- S0700
- VQ
- VQ4
- VQ5
- VQC
- VQC4
- VQZ
- SQ
- VFS
- VFR
- VQ7

# Series VQ5000

**T**

Kit (Terminal block box kit)

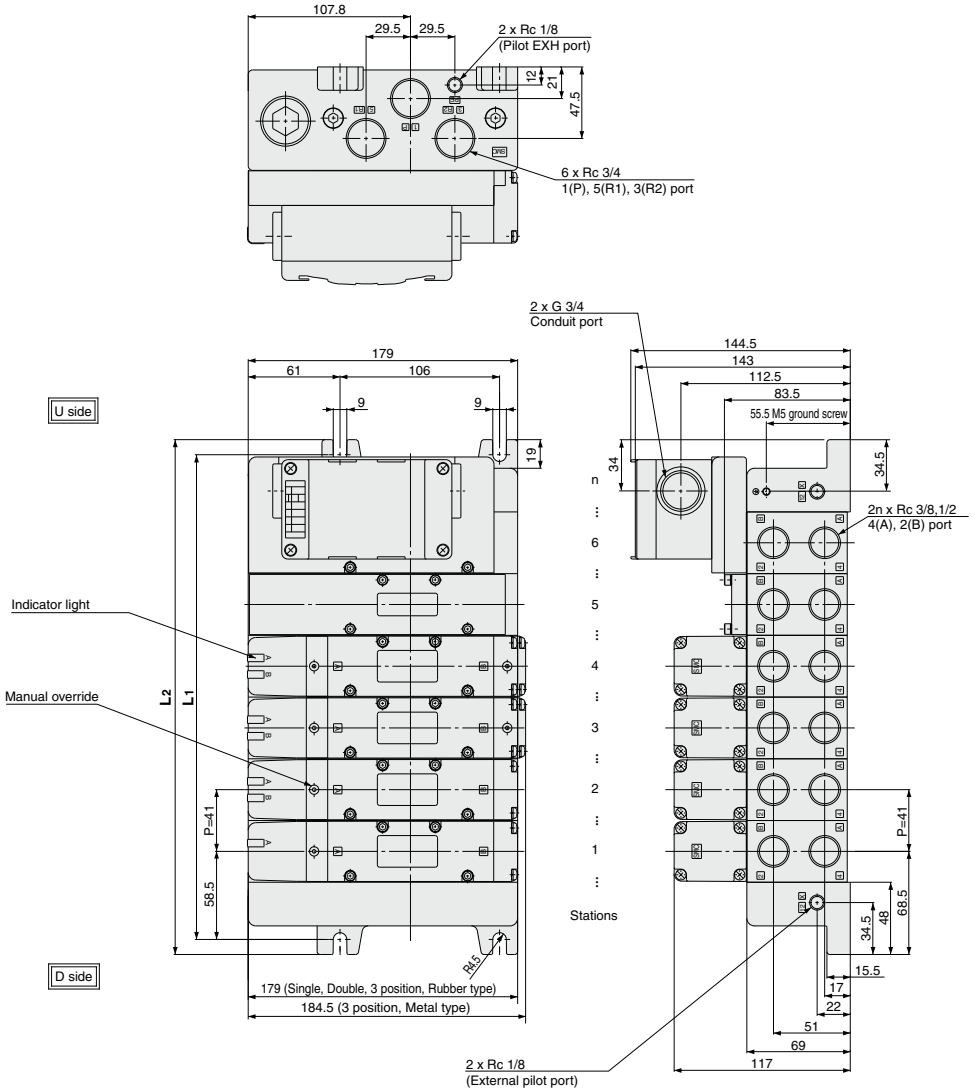

**Bottom ported drawing**

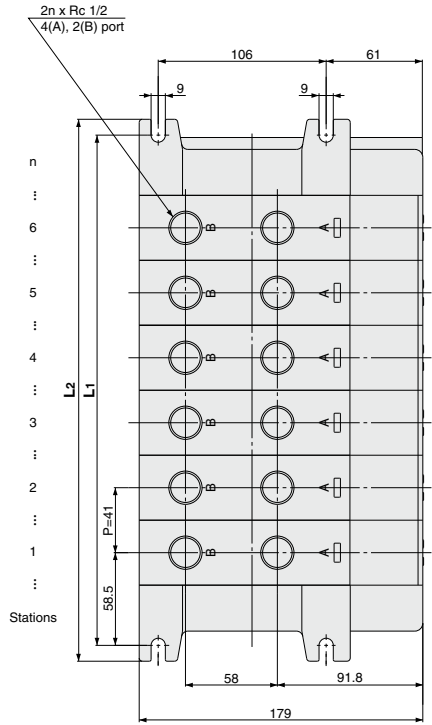
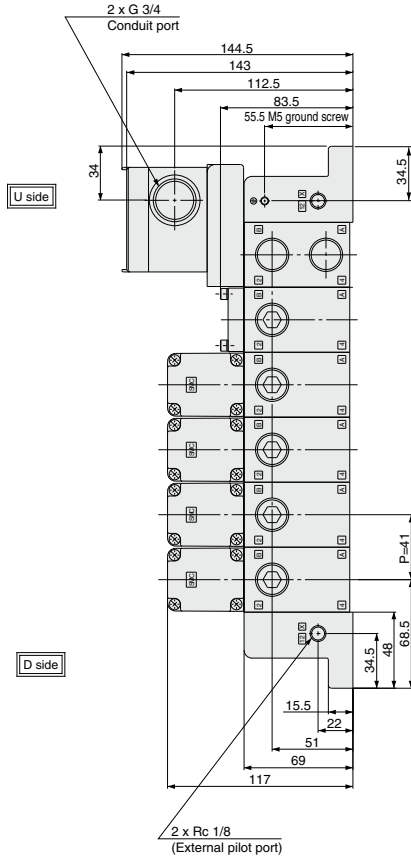

Formula:  $L1 = 41n + 76$ ,  $L2 = 41n + 96$

n: Stations (Maximum 12 stations)

\* Including 1 station for terminal box mounting.

**Dimensions**

L	n	2	3	4	5	6	7	8	9	10	11	12
L1		158	199	240	281	322	363	404	445	486	527	568
L2		178	219	260	301	342	383	424	465	506	547	588

- SJ
- SY
- SY
- SV
- SYJ
- SZ
- VF
- VP4
- S0700
- VQ
- VQ4
- VQ5**
- VQC
- VQC4
- VQZ
- SQ
- VFS
- VFR
- VQ7

# Series VQ5000

## T1 Kit (Individual terminal block kit)

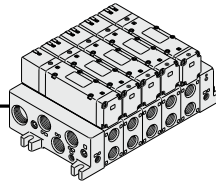

- When the junction cover on the manifold is opened, terminal box is installed in the manifold block. Lead wire from a solenoid is connected with the terminals on the terminal box in the bottom side. (The terminal box is connected with lead wire for both SOL. A and SOL. B and they correspond with the marking 1, 2, 3, 4 on the terminal box. Refer to how to connect with the terminal box.)
- Maximum stations are 12.

### Manifold Specifications

Series	Porting specifications			Applicable stations
	4(A), 2(B) port location	Port size		
VQ5000	Side	Rc 3/4	Rc 3/8, 1/2	Max. 12 stations
	Bottom		Rc 1/2	

### Terminal Block Connections

Terminal block marking	1	3	2	4
VQ510 <sup>0</sup>	A side +	A side -		
VQ520 <sup>0</sup>	A side +	A side -	B side +	B side -
VQ540 <sup>0</sup> <sub>3 5</sub>	A side +	A side -	B side +	B side -

- Compatible crimp terminals: 1.25-3S, 1.25Y-3, 1.25Y-3N, 1.25Y-3.5
- There is no polarity (+, -).

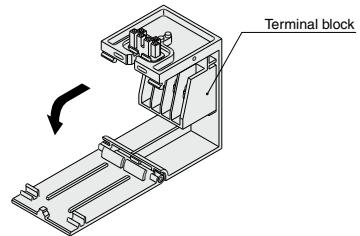
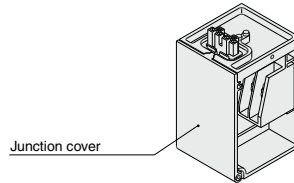
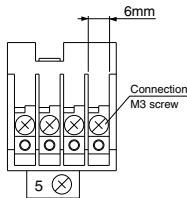
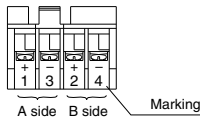

### How to Order Manifold

VV5Q 5 1 - 08 03 T1 - SD -

**Series**  
5 VQ5000

**Manifold**  
1 Plug-in unit

**Stations**

1	1 station
⋮	⋮
12	12 stations

**Cylinder port**

03	Rc 3/8
04	Rc 1/2
B	Bottom ported Rc 1/2
CM	Mixed

**CE-compliant**

Nil	—
Q	CE-compliant

#### Option

Symbol	Option
Nil	None
CD1 <sup>(1)</sup>	Exhaust cleaner for Rc 1: D side exhaust
CD2 <sup>(1)</sup>	Exhaust cleaner for Rc 1 1/2: D side exhaust
CU1 <sup>(1)</sup>	Exhaust cleaner for Rc 1: U side exhaust
CU2 <sup>(1)</sup>	Exhaust cleaner for Rc 1 1/2: U side exhaust
SB	Direct exhaust with silencer box: Exhaust from both U and D sides
SD <sup>(1)</sup>	Direct exhaust with silencer box: D side exhaust
SU <sup>(1)</sup>	Direct exhaust with silencer box: U side exhaust

Note 1) Combination of [C<sub>1</sub>C<sub>2</sub>] and [S<sub>1</sub>] is not possible.



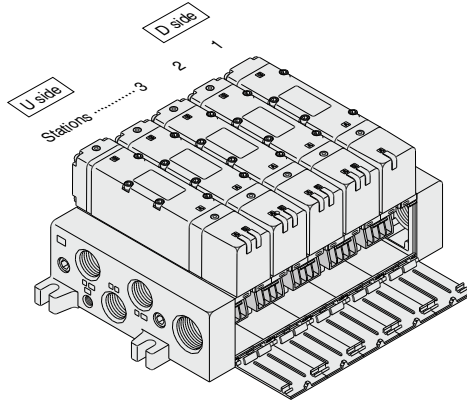

SJ
SY
SV
SYJ
SZ
VF
VP4
S0700
VQ
VQ4
VQ5
VQC
VQC4
VQZ
SQ
VFS
VFR
VQ7

## How to Order Valves



**VQ 5 1 0 0** [ ] - **5** [ ] [ ] [ ] - [ ]

**Series**

5	VQ5000
---	--------

**Type of actuation**

1	2 position single
2	2 position double
3	3 position closed center
4	3 position exhaust center
5	3 position pressure center
6	3 position double check

**Seal**

0	Metal seal
1	Rubber seal

**CE-compliant**

Nil	—
Q	CE-compliant

**Manual override**

Nil	Non-locking push type (Tool required)
B	Locking type (Tool required)

**Light/Surge voltage suppressor**

Nil	Yes
E	Without light, with surge voltage suppressor

**Coil voltage**

1	100 VAC (50/60 Hz)
2	200 VAC (50/60 Hz)
3	110 VAC (50/60 Hz)
4	220 VAC (50/60 Hz)
5	24 VDC
6	12 VDC

**Function**

Nil	Standard type (1 W)
Y <sup>(1)</sup>	Low wattage type (0.5 W)
R <sup>(2)</sup>	External pilot

Note 1) Applicable to DC specification. Please select when you expect to energize the unit for extended periods of time. Refer to page 3 for details.

Note 2) Refer to page 1145 for details on external pilot specifications.

Note 3) When two or more symbols are specified, indicate them alphabetically.

## How to Order Manifold Assembly (Order example)

Specify the part numbers for valves and options together beneath the manifold base part number.

**<Example>**  
Individual terminal block kit  
VW051-0503T1(-Q) ... 1 set — Manifold base part no.  
\*VQ5100-5(-Q) ... 2 sets — Valve part no. (Stations 1 and 2)  
\*VQ5200-5(-Q) ... 2 sets — Valve no. (Stations 3 and 4)  
\*VQ5300-5(-Q) ... 1 set — Valve part no. (Station 5)

Prefix the asterisk to the part nos. of the solenoid valve, etc.

Enter in order starting from the first station on the D side. When entry of part numbers becomes complicated, indicate in the manifold specification sheet.

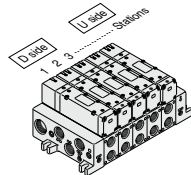

# Series VQ5000



## Kit (Individual terminal block kit)

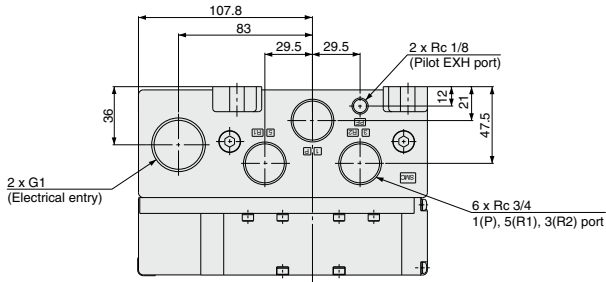

U side

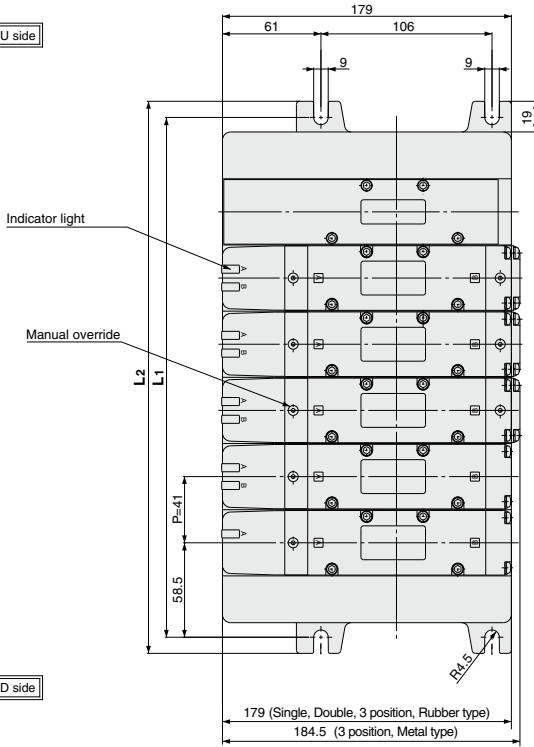

D side

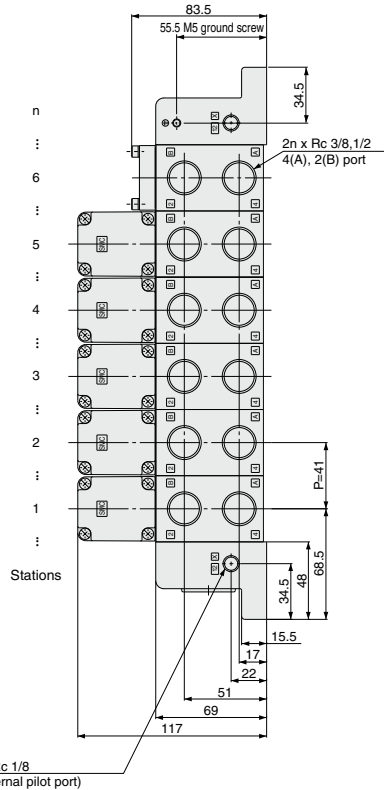

**Bottom ported drawing**

U side

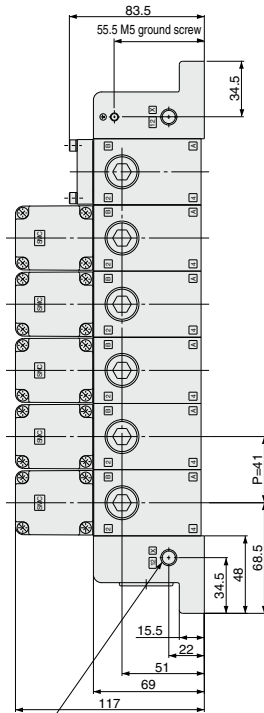

D side

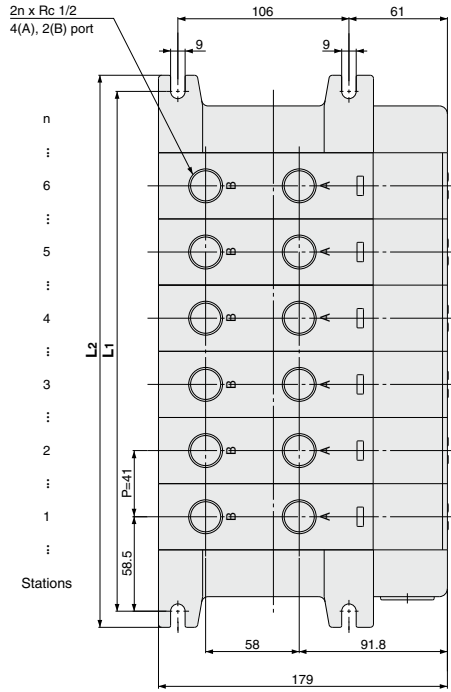

2 x Rc 1/8  
(External pilot port)

- SJ
- SY
- SY
- SV
- SYJ
- SZ
- VF
- VP4
- S0700
- VQ
- VQ4
- VQ5**
- VQC
- VQC4
- VQZ
- SQ
- VFS
- VFR
- VQ7

**Dimensions**

Formula:  $L1 = 41n + 76$ ,  $L2 = 41n + 96$   
n: Stations (Maximum 12 stations)

L	n	1	2	3	4	5	6	7	8	9	10	11	12
L1		117	158	199	240	281	322	363	404	445	486	527	568
L2		137	178	219	260	301	342	383	424	465	506	547	588

# Series VQ5000

**L** Kit (Lead wire cable)

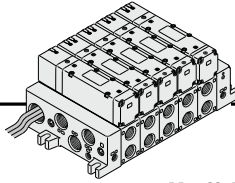

**IP65 compliant**

- Enclosure IP65 compliant
- Direct electrical entry type available with two or more stations.
- Electrical entry can be selected on either the U side or the D side according to the mounting orientation.
- Maximum stations are 12.

## Manifold Specifications

Series	Porting specifications			Applicable stations
	4(A), 2(B) port location	Port size		
		1(P), 5(R1), 3(R2)	4(A), 2(B)	
<b>VQ5000</b>	Side	Rc 3/4	Rc 3/8 Rc 1/2	Max. 12 stations
	Bottom		Rc 1/2	

## Wiring Specifications

Three lead wires are attached to each station regardless of the type of valve which is mounted. The red wire is for COM connection.

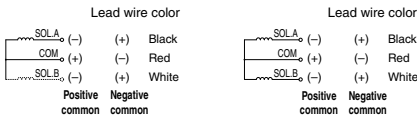

Single solenoid

Double solenoid

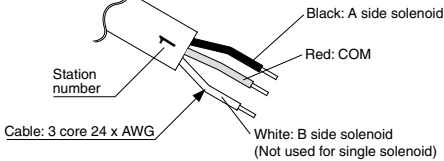

For different lead wire lengths, order a lead wire assembly with connector shown in the table on the right.

## Lead Wire Assembly with Connector

Lead wire length	Part no.
0.6 m	VVQ5000-44A-8-□
1.5 m	VVQ5000-44A-15-□
3 m	VVQ5000-44A-30-□

□: Number of stations 1 to 12

## How to Order Manifold

**CE**  
[Option]

**VV5Q 5 1 - 08 03 L U** - - -

**Series**  
5 VQ5000

**Manifold**  
1 Plug-in unit

**Stations**

01	1 station
:	:
12	12 stations

**Electrical entry**

D	D side entry
U	U side entry

**CE-compliant**

Nil	—
Q	CE-compliant

### Option

Symbol	Option
Nil	None
CD1 <sup>(1)</sup>	Exhaust cleaner for Rc 1: D side exhaust
CD2 <sup>(1)</sup>	Exhaust cleaner for Rc 1 1/2: D side exhaust
CU1 <sup>(1)</sup>	Exhaust cleaner for Rc 1: U side exhaust
CU2 <sup>(1)</sup>	Exhaust cleaner for Rc 1 1/2: U side exhaust
SB	Direct exhaust with silencer box: Exhaust from both U and D sides
SD <sup>(1)</sup>	Direct exhaust with silencer box: D side exhaust
SU <sup>(1)</sup>	Direct exhaust with silencer box: U side exhaust
W	IP65 enclosure

Note 1) Combination of [C<sub>1</sub>□] and [S<sub>2</sub>□] is not possible.

**Cylinder port**

03	Rc 3/8
04	Rc 1/2
B	Bottom ported Rc 1/2
CM	Mixed

**Cable (Length)**

0	Cable length 0.6 m
1	Cable length 1.5 m
2	Cable length 3 m



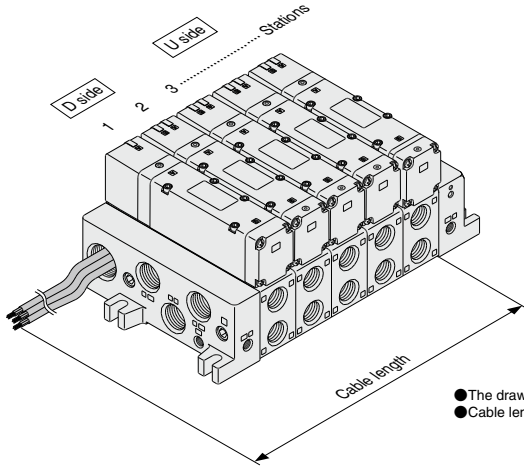

- The drawing shows the electrical entry on the D side.
- Cable length is measured from the solenoid valve body.



## How to Order Valves

**VQ 5 1 0 0** - **5** - - - -

**Series**

5	VQ5000
---	--------

**Type of actuation**

1	2 position single
2	2 position double
3	3 position closed center
4	3 position exhaust center
5	3 position pressure center
6	3 position double check

**Seal**

0	Metal seal
1	Rubber seal

**CE-compliant**

NII	—
Q	CE-compliant

**Enclosure**

NII	Dusttight
W	Dusttight/Low jetproof type(IP65)

**Manual override**

NII	Non-locking push type (Tool required)
B	Locking type (Tool required)

**Light/Surge voltage suppressor**

NII	Yes
E	Without light, with surge voltage suppressor

**Coil voltage**

1	100 VAC (50/60 Hz)
2	200 VAC (50/60 Hz)
3	110 VAC (50/60 Hz)
4	220 VAC (50/60 Hz)
5	24 VDC
6	12 VDC

**Function**

NII	Standard type (1 W)
Y <sup>(1)</sup>	Low wattage type (0.5 W)
R <sup>(2)</sup>	External pilot

- Note 1) Applicable to DC specification. Please select when you expect to energize the unit for extended periods of time. Refer to page 3 for details.
- Note 2) Refer to page 1145 for details on external pilot specifications.
- Note 3) When two or more symbols are specified, indicate them alphabetically.

## How to Order Manifold Assembly [Order example]

Specify the part numbers for valves and options together beneath the manifold base part number.

### <Example>

- Lead wire kit with cable (3 m)
- VW501-0503LD2-Q) --1 set—Manifold base part no.
- VQ5100-5-(Q) .....2 sets —Valve part no. (Stations 1 and 2)
- VQ5200-5-(Q) .....2 sets —Valve part no. (Stations 3 and 4)
- VQ5300-5-(Q) .....1 set —Valve part no. (Station 5)

Prefix the asterisk to the part nos. of the solenoid valve, etc.

Enter in order starting from the first station on the D side. When entry of part numbers becomes complicated, indicate in the manifold specification sheet.

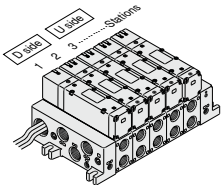

- SJ
- SY
- SV
- SYJ
- SZ
- VF
- VP4
- S0700
- VQ
- VQ4
- VQ5
- VQC
- VQC4
- VQZ
- SQ
- VFS
- VFR
- VQ7

# Series VQ5000

## L Kit (Lead wire cable)

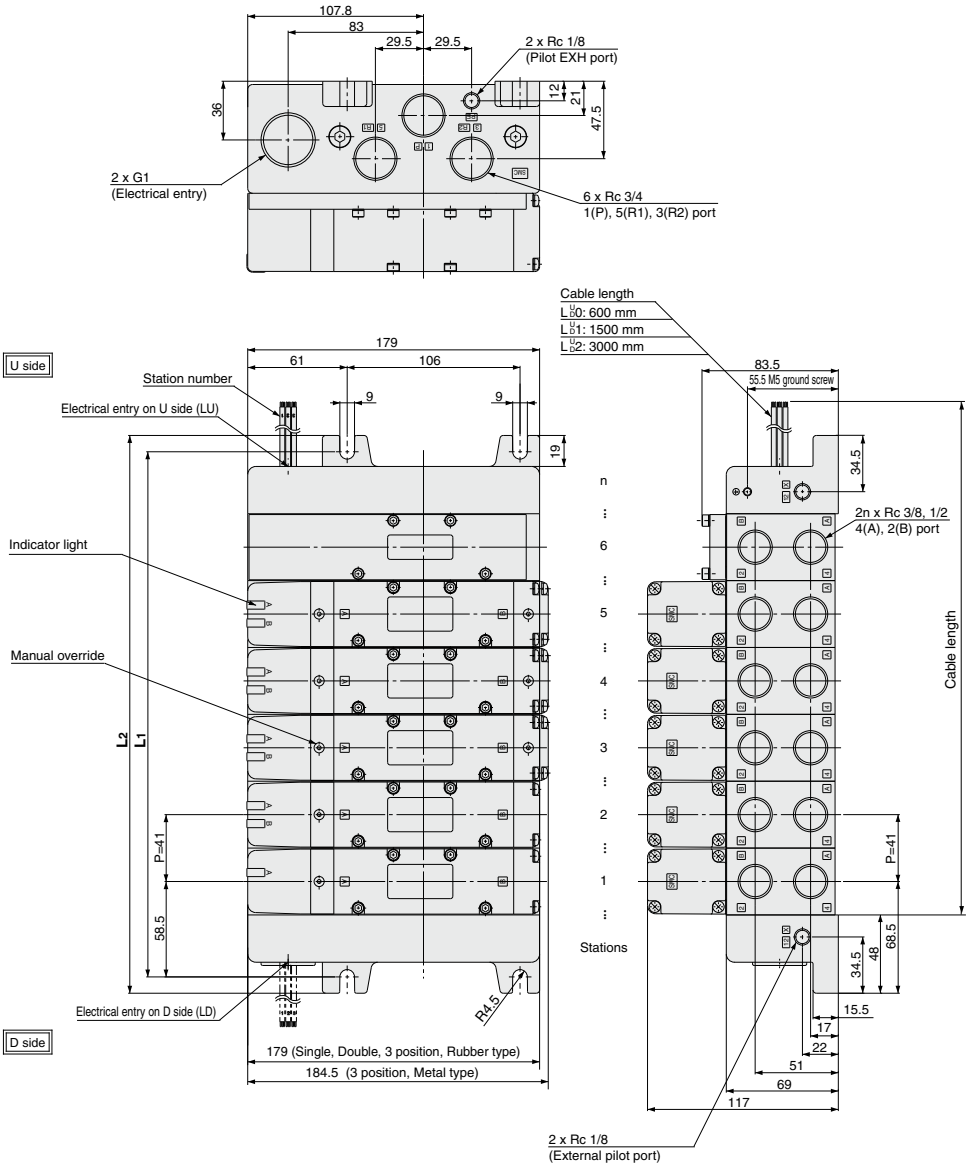

**Bottom ported drawing**

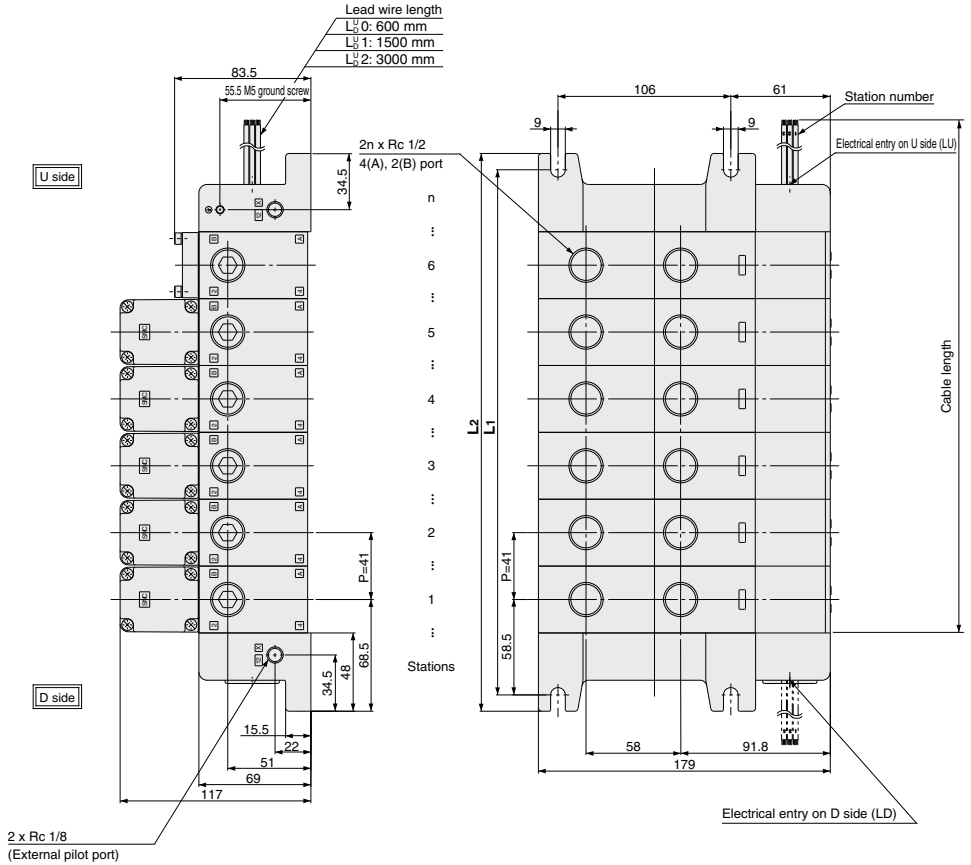

- SJ
- SY
- SY
- SV
- SYJ
- SZ
- VF
- VP4
- S0700
- VQ
- VQ4
- VQ5**
- VQC
- VQC4
- VQZ
- SQ
- VFS
- VFR
- VQ7

**Dimensions**

Formula:  $L_1 = 41n + 76$ ,  $L_2 = 41n + 96$   
 n: Stations (Maximum 12 stations)

L \ n	1	2	3	4	5	6	7	8	9	10	11	12
L1	117	158	199	240	281	322	363	404	445	486	527	568
L2	137	178	219	260	301	342	383	424	465	506	547	588

# Series VQ5000

# S

Kit (Serial transmission unit): EX123/124 (For Output) Serial Transmission System **IP65 compliant**

- The serial transmission system reduces wiring work, while minimizing wiring and saving space.

## Manifold Specifications

Series	4(A), 2(B) port location	Porting specifications		Applicable stations
		Port size		
		1(P), 5(R1), 3(R2)	4(A), 2(B)	
VQ5000	Side	Rc 3/4	Rc 3/8	Max. 12 stations
	Bottom		Rc 1/2	

- Double wiring (connected to SOL. A and SOL. B) is adopted for the internal wiring of each station, regardless of valve and option types. Mixed single and double wiring is available as an option.

Item	Specifications
External power supply	24 VDC +10%, -5%
Current consumption (Internal unit)	0.1 A



## How to Order Manifold

VV5Q 5 1 - 08 03 S U Q - - -

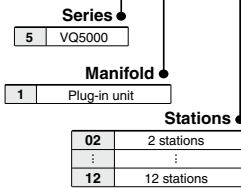

Note) One station is used for mounting SI unit.  
The number of stations is the number of manifold valves plus one station for SI unit. For 10 stations or more, specify the wiring specifications by means of the manifold specification sheet.

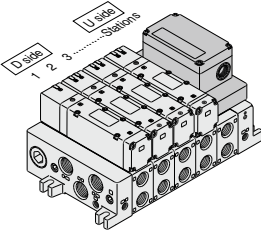

\* Stations are counted starting from the first station on the D side.

### Cylinder port

03	Rc 3/8
04	Rc 1/2
B	Bottom ported Rc 1/2
CM	Mixed

### SI unit mounting position

D	D side mounting
U	U side mounting

### Option

Symbol	Option
Nll	None
CD1 <sup>(2)</sup>	Exhaust cleaner for Rc 1: D side exhaust
CD2 <sup>(2)</sup>	Exhaust cleaner for Rc 11/2: D side exhaust
CU1 <sup>(2)</sup>	Exhaust cleaner for Rc 1: U side exhaust
CU2 <sup>(2)</sup>	Exhaust cleaner for Rc 11/2: U side exhaust
K <sup>(3)</sup>	Special wiring specifications (except double wiring specification, 10 stations or more)
SD <sup>(2)</sup>	Direct exhaust with silencer box: D side exhaust
SU <sup>(2)</sup>	Direct exhaust with silencer box: U side exhaust
W	IP65 enclosure

Note 1) When two or more symbols are specified, indicate them alphabetically. Example) -CD1K.

Note 2) Combination of [C<sub>1</sub><sup>(2)</sup>] and [S<sub>1</sub><sup>(2)</sup>] is not possible.

Note 3) Specify the wiring specifications on the manifold specification sheet.

Symbol	Option
Nll	—
Q	CE-compliant

### SI unit

Symbol	Without SI unit	CE-compliant
0	Without SI unit	●
F1	NKE Corp.: Fieldbus System	—
H	NKE Corp.: Fieldbus H System	—
J1	Panasonic Industrial Devices SUNX Co., Ltd.: S-LINK System (16 output points)	—
J2	Panasonic Industrial Devices SUNX Co., Ltd.: S-LINK System (8 output points)	—
Q	DeviceNet	●
R1	OMRON Corp.: CompoBus/S System (16 output points)	●
R2	OMRON Corp.: CompoBus/S System (8 output points)	●
V	CC-LINK System	●

### SI Unit Part No.

Symbol	Protocol type	SI unit part no.	Page
F1	NKE Corp.: Fieldbus System	D side: EX123D-SUW1	P. 1149
		U side: EX123U-SUW1	
H	NKE Corp.: Fieldbus H System	D side: EX123D-SUH1	P. 1149
		U side: EX123U-SUH1	
J1	Panasonic Industrial Devices SUNX Co., Ltd.: S-LINK System (16 output points)	D side: EX123D-SSL1	P. 1149
		U side: EX123U-SSL1	
J2	Panasonic Industrial Devices SUNX Co., Ltd.: S-LINK System (8 output points)	D side: EX123D-SSL2	P. 1149
		U side: EX123U-SSL2	
Q	DeviceNet	D side: EX124D-SDN1	P. 1149
		U side: EX124U-SDN1	
R1	OMRON Corp.: CompoBus/S System (16 output points)	D side: EX124D-SCS1	P. 1149
		U side: EX124U-SCS1	
R2	OMRON Corp.: CompoBus/S System (8 output points)	D side: EX124D-SCS2	P. 1149
		U side: EX124U-SCS2	
V	CC-Link	D side: EX124D-SMJ1	P. 1149
		U side: EX124U-SMJ1	

Refer to page 2055 and the Operation Manual for the details of EX123/124 Integrated-type (For Output) Serial Transmission System.  
Please download the Operation Manual via our website, <http://www.smcworld.com>



## How to Order Valves

**VQ 5 1 0 0** [ ] - 5 [ ] [ ] [ ] - [ ]

**Series**

5	VQ5000
---	--------

**Type of actuation**

1	2 position single
2	2 position double
3	3 position closed center
4	3 position exhaust center
5	3 position pressure center
6	3 position double check

**Seal**

0	Metal seal
1	Rubber seal

**CE-compliant**

Nil	—
Q	CE-compliant

**Enclosure**

Nil	Dusttight
W	Dusttight/Low jetproof type (IP65)

**Manual override**

Nil	Non-locking push type (Tool required)
B	Locking type (Tool required)

**Light/Surge voltage suppressor**

Nil	Yes
E	Without light, with surge voltage suppressor

**Coil voltage**

5	24 VDC
---	--------

**Function**

Nil	Standard type (1 W)
Y <sup>(1)</sup>	Low wattage type (0.5 W)
R <sup>(2)</sup>	External pilot

Note 1) Applicable to DC specification. Please select when you expect to energize the unit for extended periods of time. Refer to page 3 for details.

Note 2) Refer to page 1145 for details on external pilot specifications.

Note 3) When two or more symbols are specified, indicate them alphabetically.

## How to Order Manifold Assembly [Order example]

Specify the part numbers for valves and options together beneath the manifold base part number.

### <Example>

VV5051-0603SUQ(-Q) ... 1 set—Manifold base part no.

-VQ5100-5(-Q) ..... 2 sets—Valve part no. (Stations 1 and 2)  
 -VQ5200-5(-Q) ..... 2 sets—Valve part no. (Stations 3 and 4)  
 -VQ5300-5(-Q) ..... 1 set—Valve part no. (Station 5)

Prefix the asterisk to the part nos. of the solenoid valve, etc.

Enter in order starting from the first station on the D side. When entry of part numbers becomes complicated, indicate in the manifold specification sheet.

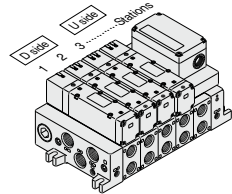

- SJ
- SY
- SY
- SV
- SYJ
- SZ
- VF
- VP4
- S0700
- VQ
- VQ4
- VQ5**
- VQC
- VQC4
- VQZ
- SQ
- VFS
- VFR
- VQ7

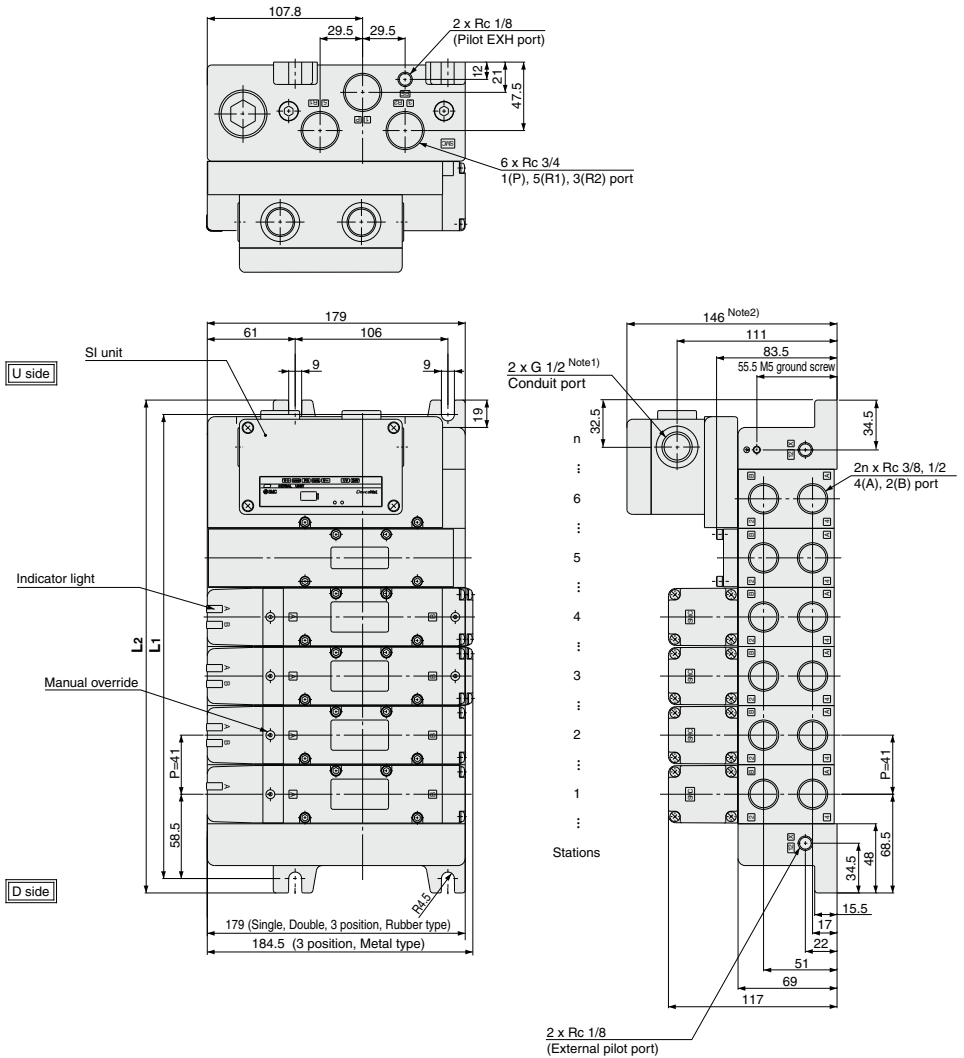

Note1) When the SI unit is EX124D (U), conduit port (G1/2) will be 4 locations. In the case of EX123D (U), conduit port will be 2 locations.

Note2) In the case of EX124D (U)-SMJI, this dimension becomes 149.

**Bottom port drawing**

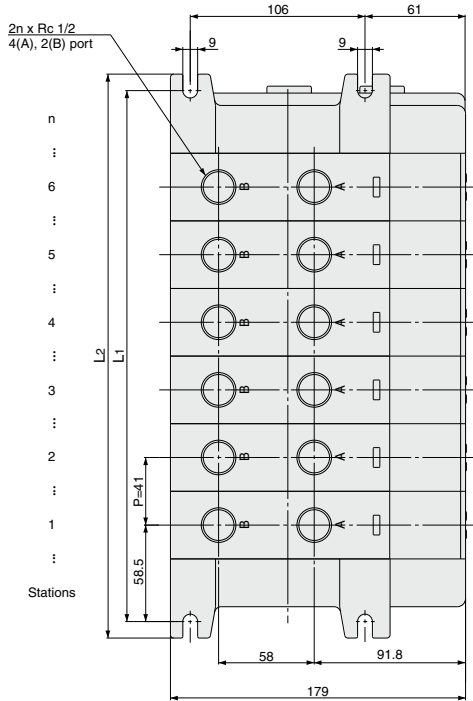
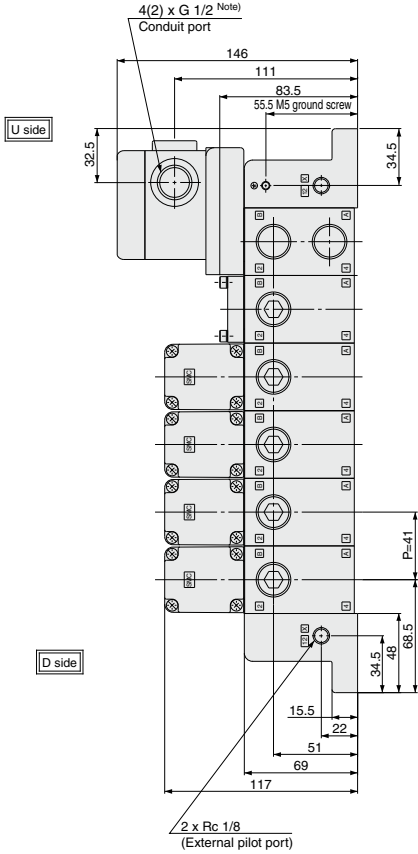

- SJ
- SY
- SY
- SV
- SYJ
- SZ
- VF
- VP4
- S0700
- VQ
- VQ4
- VQ5**
- VQC
- VQC4
- VQZ
- SQ
- VFS
- VFR
- VQ7

Formula:  $L1 = 41n + 76$ ,  $L2 = 41n + 96$

n: Stations (Maximum 12 stations)

\* Including 1 station for SI unit box mounting

**Dimensions**

L	n	2	3	4	5	6	7	8	9	10	11	12
L1		158	199	240	281	322	363	404	445	486	527	568
L2		178	219	260	301	342	383	424	465	506	547	588

# Base Mounted

# Plug Lead Unit: C Kit (Connector Kit)

# Series VQ5000



## How to Order Manifold

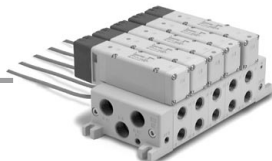

VV5Q 5 5 - 08 03 C - W - [ ]

### Series

5	VQ5000
---	--------

### Manifold

5	Plug lead unit
---	----------------

### Stations

01	1 station
⋮	⋮
12	12 stations

### Cylinder port

03	Rc 3/8
04	Rc 1/2
B	Bottom ported Rc 1/2
CM	Mixed

### Kit type

**C** kit (Connector)

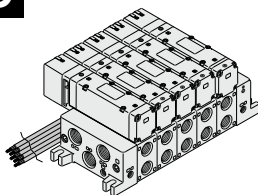

C Connector kit Max. 12 stations

### CE-compliant

Nil	—
Q	CE-compliant

### Option

Symbol	Option
Nil	None
CD1 (1)	Exhaust cleaner for Rc 1: D side exhaust
CD2 (1)	Exhaust cleaner for Rc 1 1/2: D side exhaust
CU1 (1)	Exhaust cleaner for Rc 1: U side exhaust
CU2 (1)	Exhaust cleaner for Rc 1 1/2: U side exhaust
SB	Direct exhaust with silencer box: Exhaust from both U and D sides
SD (1)	Direct exhaust with silencer box: D side exhaust
SU (1)	Direct exhaust with silencer box: U side exhaust
W	IP65 enclosure

Note 1) Combination of [C] and [S] is not possible.

Refer to page 1151 (Grommet style) for wiring specifications.

## How to Order Valves

VQ 5 1 5 0 [ ] - 5 G [ ] [ ] [ ] - [ ]

### Series

5	VQ5000
---	--------

### Type of actuation

1	2 position single
2	2 position double
3	3 position closed center
4	3 position exhaust center
5	3 position pressure center
6	3 position double check

### Seal

0	Metal seal
1	Rubber seal

### Function

Nil	Standard type (1 W)
Y (1)	Low wattage type (0.5 W)
R (2)	External pilot

Note 1) Applicable to DC specification. Please select when you expect to energize the unit for extended periods of time. Refer to page 3 for details.

Note 2) Refer to page 1145 for details on external pilot specifications.

Note 3) When two or more symbols are specified, indicate them alphabetically.

### Coil voltage

1	100 VAC (50/60 Hz)	4	220 VAC (50/60 Hz)
2	200 VAC (50/60 Hz)	5	24 VDC
3	110 VAC (50/60 Hz)	6	12 VDC

### CE-compliant

Nil	—
Q	CE-compliant

### Enclosure

Nil	Dusttight
W	Dusttight/Low jetproof type (IP65)

### Manual override

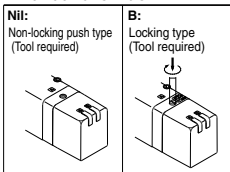

### Light/Surge voltage suppressor

Nil	Yes
E	Without light, with surge voltage suppressor

### Electrical entry

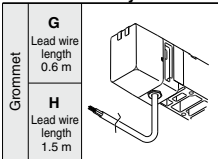

## How to Order Manifold Assembly [Order example]

Specify the part numbers for valves and options together beneath the manifold base part number.

<Example>  
Connector kit

- VQ505-0502C(Q)-1 set—Manifold base part no.
- + VQ5150-5G(Q) ... 2 sets—Valve part no. (Stations 1 and 2)
- + VQ5250-5G(Q) ... 2 sets—Valve part no. (Stations 3 and 4)
- + VQ5350-5G(Q) ... 1 set—Valve part no. (Station 5)

Prefix the asterisk to the part nos. of the solenoid valve, etc.

Enter in order starting from the first station on the D side.  
When entry of part numbers becomes complicated, indicate in the manifold specification sheet.

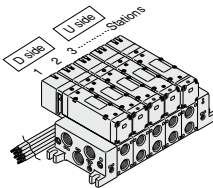



**Manifold Specifications**

Series	Base model	Type of connection	Porting specifications		Maximum applicable stations	Applicable solenoid valve	Weight (kg) (Formula)	
			4(A), 2(B) port location	Port size <small>Note)</small>				
				1(P), 5(R1), 3(R2)				4(A), 2(B)
VQ5000	VVQ5055-□□□	■ C kit-Grommet	Side	Rc 3/4 Option (Direct exhaust with silencer box)	Rc 3/8 Rc 1/2	2 to 12 stations	VQ5□50 VQ5□51	0.58n+0.9 • Except solenoid valve mass
			Bottom		Rc 1/2			

Note) For details about international standard threads other than Rc threads, refer to "Option" on page 1145.

n: Stations

**Flow Characteristics at the Number of Manifold Stations (Operated Individually)**

Model	Passage/Stations		Station 1	Station 5	Station 10
2 position metal seal VQ5 <sub>2</sub> 00	1 → 4/2 (P → A/B)	C [dm <sup>3</sup> /(s·bar)]	11	11	11
		b	0.24	0.24	0.24
		Cv	2.7	2.7	2.7
	4/2 → 5/3 (A/B → EA/EB)	C [dm <sup>3</sup> /(s·bar)]	12	12	12
		b	0.14	0.14	0.14
		Cv	2.9	2.9	2.9
2 position rubber seal VQ5 <sub>2</sub> 01	1 → 4/2 (P → A/B)	C [dm <sup>3</sup> /(s·bar)]	12	12	12
		b	0.33	0.33	0.33
		Cv	3.4	3.4	3.4
	4/2 → 5/3 (A/B → EA/EB)	C [dm <sup>3</sup> /(s·bar)]	16	16	16
		b	0.33	0.33	0.33
		Cv	4.4	4.4	4.4

Note) For port size Rc 1/2

**Manifold Options**

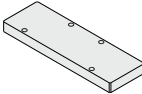
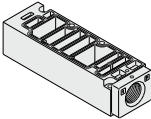
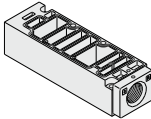
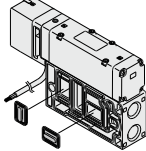
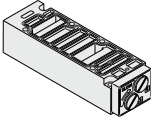
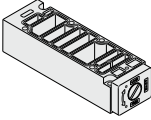
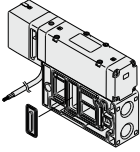
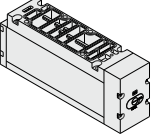
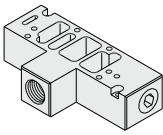
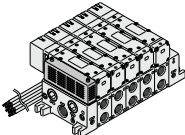
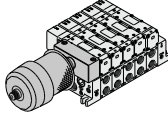
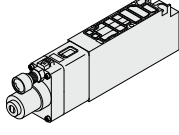
<b>Blanking plate assembly</b> VVQ5000-10A-5 	<b>Individual SUP spacer</b> VVQ5000-P-5 <sup>03</sup> / <sub>04</sub> 	<b>Individual EXH spacer</b> VVQ5000-R-5 <sup>03</sup> / <sub>04</sub> 	<b>EXH block plate</b> VVQ5000-16A-2 
<b>Throttle valve spacer</b> VVQ5000-20A-5 	<b>SUP stop valve spacer</b> VVQ5000-37A-5 	<b>SUP block plate</b> VVQ5000-16A-1 	<b>Double check spacer with residual pressure release valve</b> VVQ5000-25A-5 
<b>Release valve spacer</b> VVQ5000-24A-5D 	<b>Direct exhaust with silencerbox</b> [-S□] 	<b>For exhaust cleaner mounting</b> [-C□□] 	<b>Interface regulator</b> ARBQ5000-00- <sup>A</sup> / <sub>P</sub> 5 

- Refer to pages 1140 to 1144 for detailed dimensions of each option.
- For replacement parts, refer to page 1149.

SJ  
SY  
SY  
SV  
SYJ  
SZ  
VF  
VP4  
S0700  
VQ  
VQ4  
VQ5  
VQC  
VQC4  
VQZ  
SQ  
VFS  
VFR  
VQ7

# Series VQ5000

**C**

Kit (Connector)

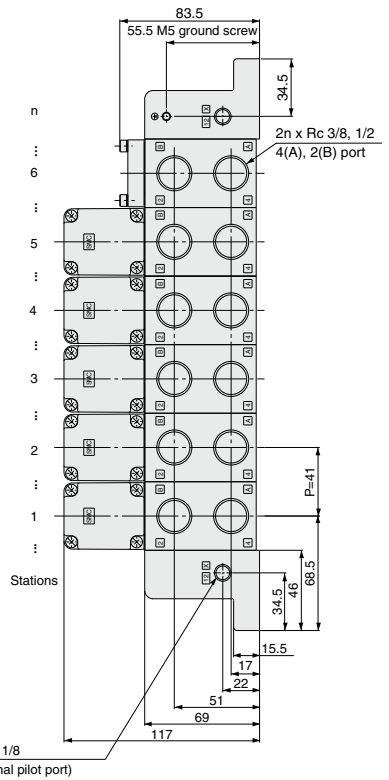
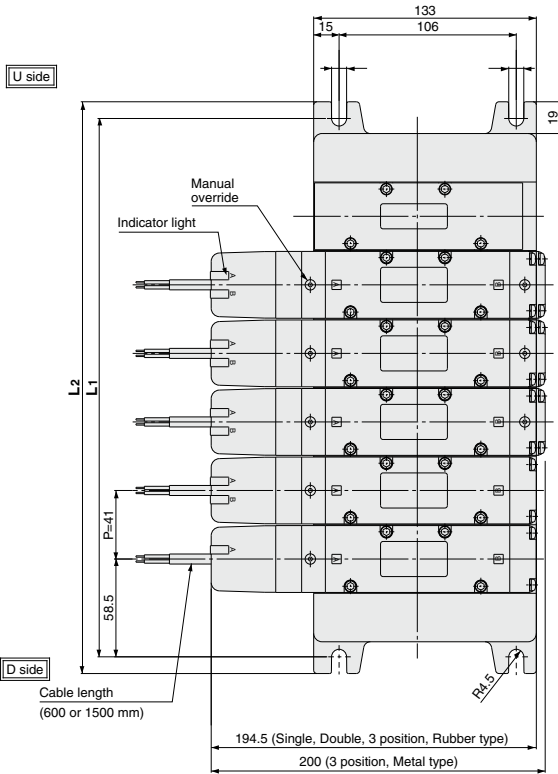
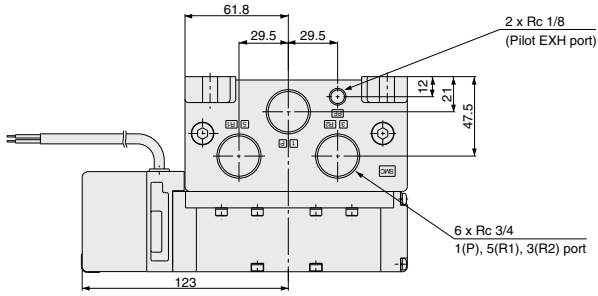

**Bottom ported drawing**

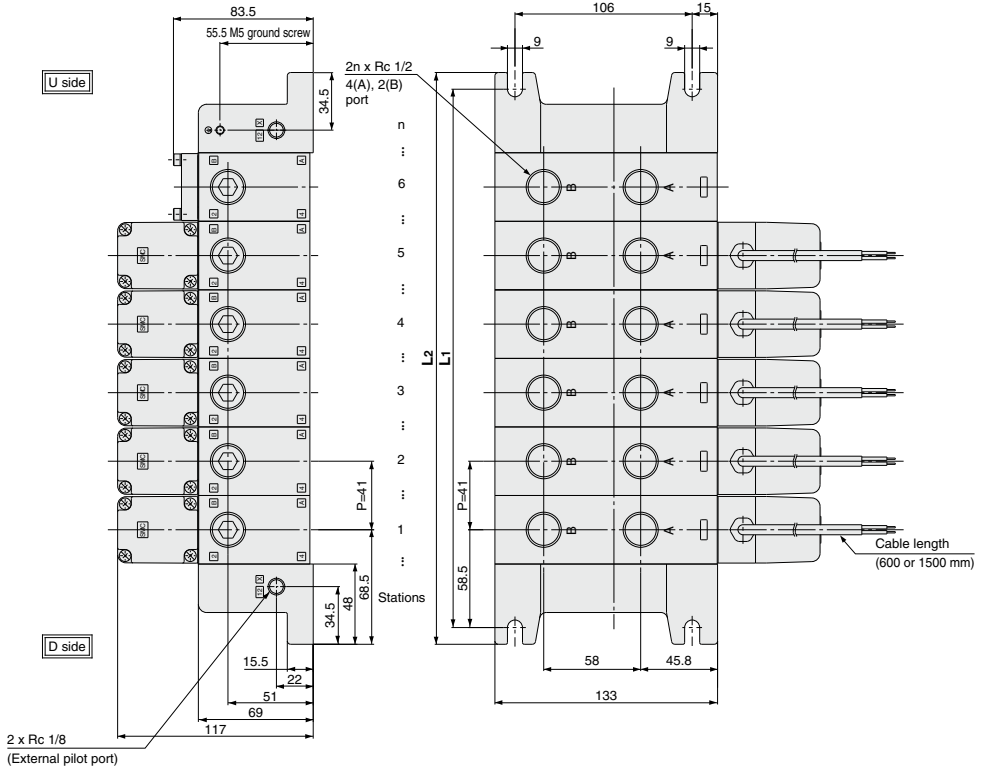

- SJ
- SY
- SY
- SV
- SYJ
- SZ
- VF
- VP4
- S0700
- VQ
- VQ4
- VQ5**
- VQC
- VQC4
- VQZ
- SQ
- VFS
- VFR
- VQ7

**Dimensions**

Formula:  $L_1 = 41n + 76$ ,  $L_2 = 41n + 96$   
 n: Stations (Maximum 12 stations)

L	n	1	2	3	4	5	6	7	8	9	10	11	12
L1		117	158	199	240	281	322	363	404	445	486	527	568
L2		137	178	219	260	301	342	383	424	465	506	547	588

# Series VQ5000

## Manifold Option Parts

### Blanking plate assembly

#### VVQ5000-10A-1 (Plug-in type) VVQ5000-10A-5 (Plug lead type)

It is used by attaching on the manifold block for being prepared for removing a valve for maintenance reasons or planning to mount a spare valve, etc.

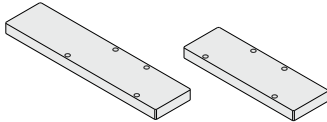

Plug-in type

Plug lead type

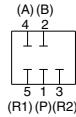

Circuit diagram

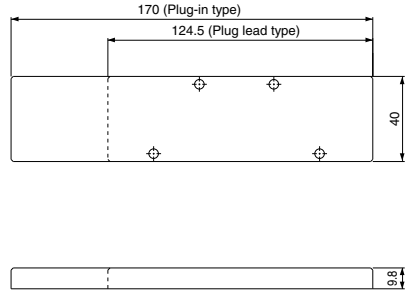

### Individual SUP spacer

#### VVQ5000-P-1-<sup>03</sup>/<sub>04</sub> (Plug-in type) VVQ5000-P-5-<sup>03</sup>/<sub>04</sub> (Plug lead type)

By mounting individual SUP spacers on a manifold block, it is possible to provide individual supply ports for each valve.

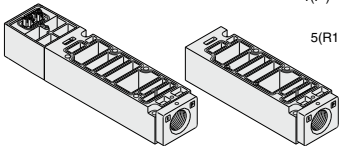

Plug-in type

Plug lead type

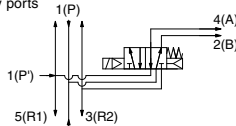

Circuit diagram

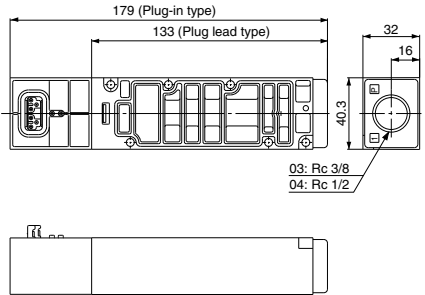

### Individual EXH spacer

#### VVQ5000-R-1-<sup>03</sup>/<sub>04</sub> (Plug-in type) VVQ5000-R-5-<sup>03</sup>/<sub>04</sub> (Plug lead type)

By mounting individual EXH spacers on a manifold block, exhaust ports can be provided individually for each valve. (Common EXH type)

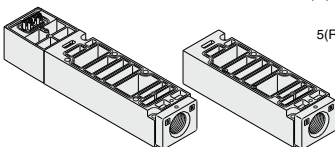

Plug-in type

Plug lead type

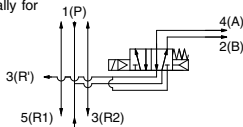

Circuit diagram

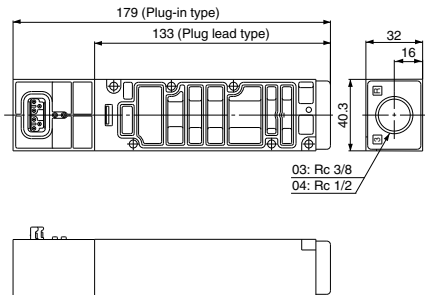

**Throttle valve spacer**

**VVQ5000-20A-1 (Plug-in type)**  
**VVQ5000-20A-5 (Plug lead type)**

A throttle valve spacer is mounted on a manifold block to control cylinder speed by throttling exhaust air flow.

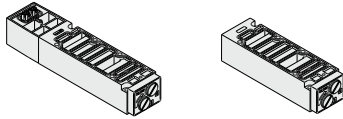

Plug-in type

Plug lead type

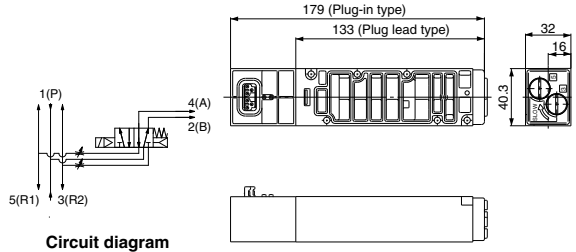

Circuit diagram

**SUP stop valve spacer**

**VVQ5000-37A-1 (Plug-in type)**  
**VVQ5000-37A-5 (Plug lead type)**

A SUP stop valve spacer is mounted on a manifold block, making it possible to individually shut off supply air to each valve.

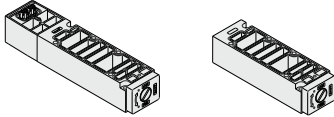

Plug-in type

Plug lead type

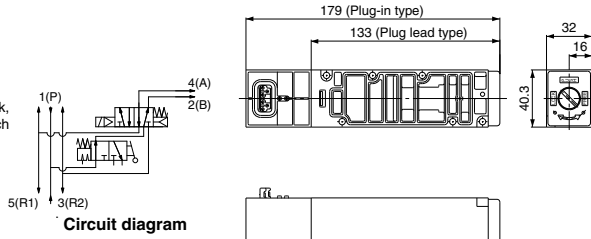

Circuit diagram

**Release valve spacer: For D side mounting**

**VVQ5000-24A-1D (Plug-in type)**  
**VVQ5000-24A-5D (Plug lead type)**

A VQ51□□ (single) valve can be used as an air release valve by combining it with a release valve spacer.  
 Note) 2 position double and 3 position cannot be mounted.

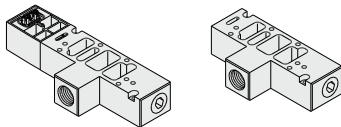

Plug-in type

Plug lead type

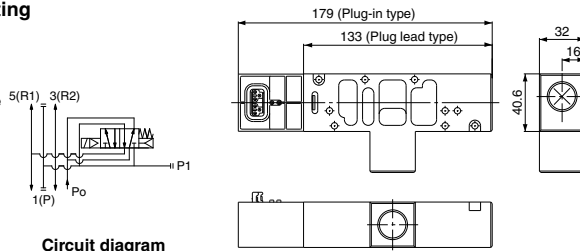

Circuit diagram

**SUP block plate**

**VVQ5000-16A-1**

**EXH block plate**

**VVQ5000-16A-2**

When supplying two different pressures to one manifold, this is used to shut off between stations with different pressures.

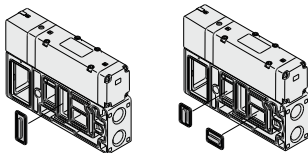

< SUP blocking plate >

< EXH blocking plate >

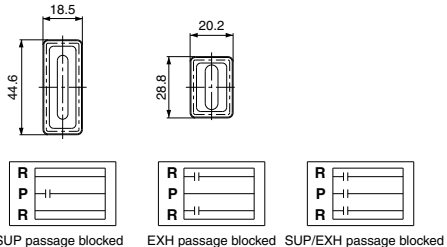

SUP passage blocked

EXH passage blocked

SUP/EXH passage blocked

SJ
SY
SY
SV
SYJ
SZ
VF
VP4
S0700
VQ
VQ4
<b>VQ5</b>
VQC
VQC4
VQZ
SQ
VFS
VFR
VQ7

## Manifold Option Parts

### Double check spacer with residual pressure release valve

#### VVQ5000-25A-1 (Plug-in type) VVQ5000-25A-5 (Plug lead type)

Can hold an intermediate cylinder position for an extended time.

When combined with a double check spacer with built-in double check valve, it is unaffected by air leakage between the spool valves, making it possible to hold a cylinder at an intermediate stopping position for an extended time.

Further, a combination of a 2 position type (VQ5<sub>2</sub> □□) and a double check spacer can be used for drop prevention.

#### Plug-in type

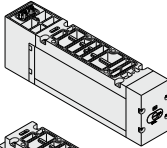

#### Plug lead type

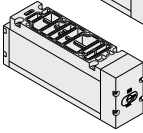

### Direct exhaust with silencer box

#### VV5Q5<sub>2</sub>-□□□-SD (D side exhaust) VV5Q5<sub>2</sub>-□□□-SU (U side exhaust) VV5Q5<sub>2</sub>-□□□-SB (Double side exhaust)

The EXH outlet is placed on the top side of the manifold end plate. The built-in silencer provides highly effective noise reduction. (Noise reduction of 35 dB or more)

Note) Note that when excessive drainage occurs in the air supply, the drainage will be released along with the exhaust.

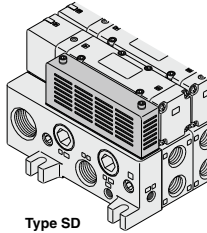

Type SD

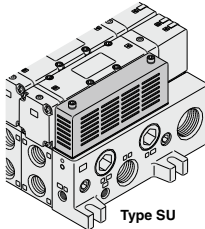

Type SU

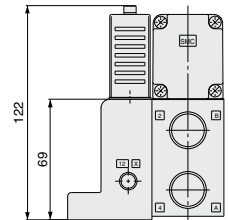
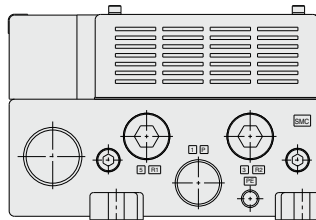
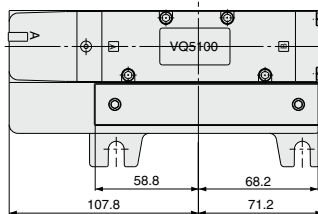

Note) The drawing shows a VV5Q51-□□□-SD.

#### Specifications

Double check spacer part no.	VVQ5000-25A- <sub>1</sub>	
	Intermediate stop	Drop prevention
Applicable solenoid valve	VQ54□□	VQ5 <sub>2</sub> □□

## ⚠ Caution

### Handling Precautions

- In the case of 3 position double check (VZS56<sub>2</sub>□0), check the leakage from piping and fittings in between valve and cylinder by means of synthetic detergent solutions, and ensure that there is no such leakage found there. Also check the leakage from cylinder seal and piston seal. If there is any leakage, sometimes the cylinder, when valve is de-energized, can move without stopping at intermediate position.
- Use caution, as excessive throttling of the double check spacer exhaust can cause a loss of intermediate stopping accuracy and malfunction.
- Combination with a 3 position VQ5<sub>2</sub>□□ is not possible.
- Set the cylinder load so that the cylinder pressure will be within two times that of the supply pressure.

Manifold Option Parts

Manifold mounted exhaust cleaner

VV5Q5<sub>5</sub>-□□□-CD<sub>2</sub> (D side mounting)  
 VV5Q5<sub>5</sub>-□□□-CU<sub>2</sub> (U side mounting)

An adapter plate for exhaust cleaner mounting is provided on the top of the manifold end plate. The exhaust cleaner collects drainage and oil mist (99.9% or more) and is highly effective for noise reduction. (Noise reduction of 35 dB or more)

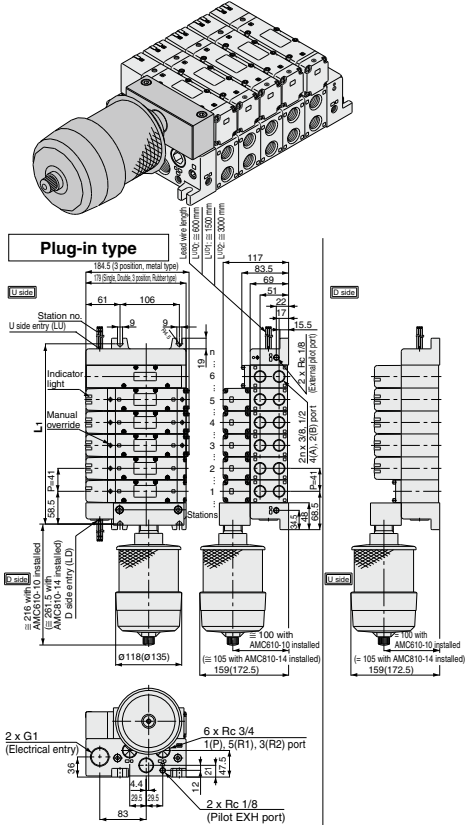

Formula: L1 = 41n + 76, L2 = 41n + 96  
 n: Stations (Maximum 12 stations)

L	n	2	3	4	5	6	7	8	9	10	11	12
L1	158	199	240	281	322	363	404	445	486	527	568	
L2	178	219	260	301	342	383	424	465	506	547	588	

Applicable exhaust cleaners

AMC610-10 (Port size Rc 1), AMC810-14 (Port size Rc 1 1/2)

- Note 1) Exhaust cleaner: AMC610-10 and MC810-14 are not included. (Order separately)
- Note 2) Mount so that the exhaust cleaner is at the lower side.
- Note 3) For details about the exhaust cleaner, refer to Best Pneumatics No. 6.

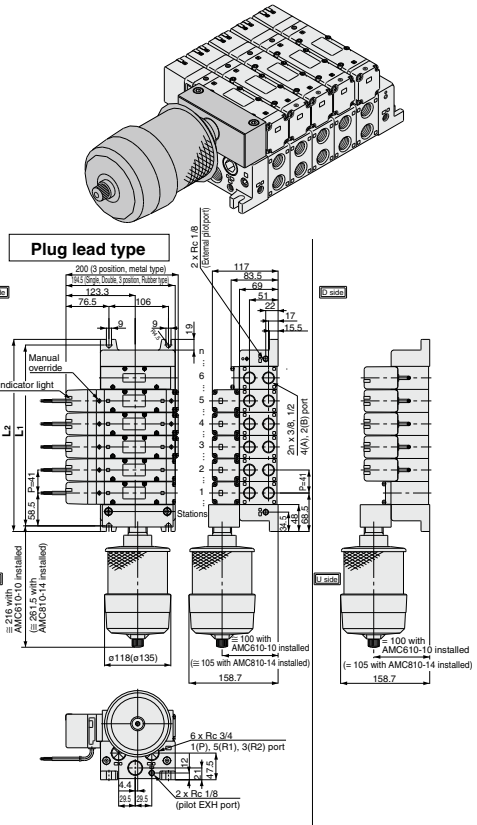

Formula: L1 = 41n + 76, L2 = 41n + 96  
 n: Stations (Maximum 12 stations)

L	n	2	3	4	5	6	7	8	9	10	11	12
L1	158	199	240	281	322	363	404	445	486	527	568	
L2	178	219	260	301	342	383	424	465	506	547	588	

- SJ
- SY
- SY
- SV
- SYJ
- SZ
- VF
- VP4
- S0700
- VQ
- VQ4
- VQ5**
- VQC
- VQC4
- VQZ
- SQ
- VFS
- VFR
- VQ7

# Series VQ5000

## Manifold Option Parts

### Interface regulator (P, A, B port regulation)

ARBQ5000-00-□-1 (Plug-in type)

ARBQ5000-00-□-5 (Plug lead type)

By mounting a spacer regulator on the manifold block, it enables to regulate pressure per every valve.

### Specifications

Interface regulator		ARBQ5000					
Regulating port		A		B		P	
Applicable solenoid valve		Plug-in	Plug lead	Plug-in	Plug lead	Plug-in	Plug lead
Maximum operating pressure		1.0 MPa					
Set pressure range		0.05 to 0.85 MPa					
Fluid		Air					
Ambient and fluid temperature		-5 to 60°C (No freezing)					
Port size for connection of pressure gauge		M5 x 0.8					
Weight (kg)		0.79	0.74	0.78	0.73	0.79	0.74
Effective area at supply side (mm <sup>2</sup> ) S at P1 = 0.7 MPa/P2 = 0.5 MPa	P → A	33		75		29	
	P → B	64		33		28	
Effective area at exhaust side (mm <sup>2</sup> ) S at P2 = 0.5 MPa	A → EA	36		75		78	
	B → EB	68		38		69	

Note 1) Set the pressure within the operating pressure range of the solenoid valve.

Note 2) Operate an interface regulator only by applying pressure from the P port of the base, except when using it as a reverse pressure valve. When using it as a reverse pressure valve, P port regulation is not allowed to use.

Note 3) When using a perfect spacer, assemble a valve, a spacer regulator and a perfect spacer in this order to use it.

Note 4) When using in A port regulation, B port regulation by closed center, since there is a problem in its operation, please contact SMC.

Note 5) Dusttight/splash proof enclosure (IP65) is not available with interface regulator.

### How to Order

Solenoid valve	Interface regulator	Regulating port
VQ5□□ (Plug-in type)	ARBQ5000-00-A-1	A
	ARBQ5000-00-B-1	B
	ARBQ5000-00-P-1	P
VQ5□□ (Plug lead type)	ARBQ5000-00-A-5	A
	ARBQ5000-00-B-5	B
	ARBQ5000-00-P-5	P

### Dimensions

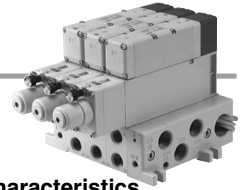
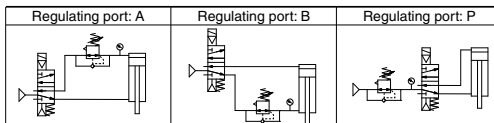
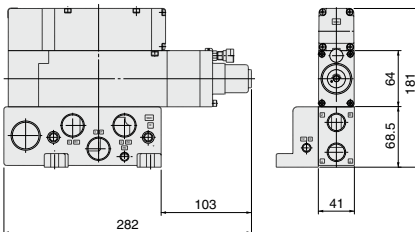

### Flow Characteristics

Conditions Inlet pressure: 0.7 MPa

ARBQ5000-00-A (P → A)

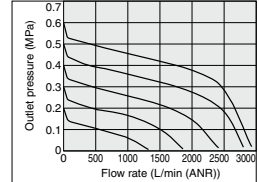

ARBQ5000-00-B (P → B)

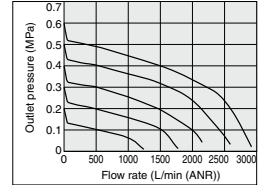

ARBQ5000-00-P (P → A)

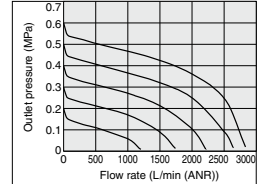

ARBQ5000-00-P (P → B)

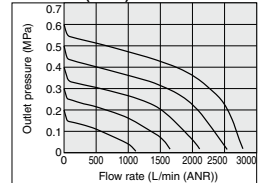

### Pressure Characteristics

Conditions

Inlet pressure: 0.7 MPa

Outlet pressure: 0.2 MPa

Flow rate: 20 L/min(ANR)

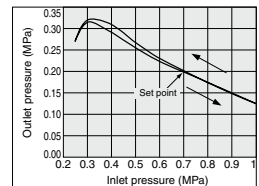



## Semi-standard Specifications

### External Pilot Specifications

When the supply pressure is

- lower than the minimum solenoid valve operating pressure of 0.1 to 0.2 MPa, or when it drops below this level,
- used for reverse pressure (R port pressure) or cylinder pressure (A, B port pressure),
- used for vacuum specifications (please contact SMC), it can be used for external pilot specifications.

Order a valve by adding the external pilot specification [R] to the part number.

External pilot is available as standard for manifolds and options.

- Compatibility with universal porting is possible for the single, double and 3P (excluding perfect spacer) types.

### How to Order Manifold

VQ5100 **[R]** - 5 - 04

External pilot specifications

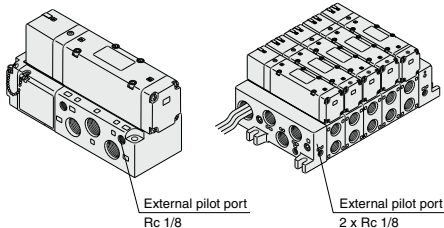

<Sub-plate>

<Manifold>

Note) Mixed mounting of internal and external pilots is possible

### Pressure Specifications

Valve construction		Metal seal	Rubber seal
Operating pressure range		Vacuum to 1.0 MPa	
External pilot <sup>Note)</sup> pressure range	Single	0.1 to 1.0 MPa (0.1 to 0.7 MPa)	0.2 to 1.0 MPa (0.2 to 0.7 MPa)
	Double		0.15 to 1.0 MPa (0.15 to 0.7 MPa)
	3 position	0.15 to 1.0 MPa (0.15 to 0.7 MPa)	0.2 to 1.0 MPa (0.2 to 0.7 MPa)

Note) Values inside ( ) denote the low wattage (0.5 W) specifications.

### International Thread Standards

Rc specifications are standard for all ports, however, NPT, NPTF and G are available for international markets.

Add the appropriate symbol following the port size in the standard part number.

### How to Order Single Valves (Example)

VQ5100 - 5 - 04

Cylinder port  
Port size

Thread type  
1(P), 5(R1), 3(R2) and 4(A),  
2(B) port

Nil	Rc
N	NPT
T	NPTF
F	G

### How to Order Manifold

VV5Q51 - 08 03 FU1

Cylinder port  
Port size

Thread type  
1(P), 5(R1), 3(R2) and 4(A),  
2(B) port

Nil	Rc
N	NPT
T	NPTF
F	G

### How to Order Sub-plates and Options (Example)

VQ5000 - P - B 04 (Sub-plate)

VVQ5000 - P - 1 - 04 (Option)

Port size

Thread type

Nil	Rc
N	NPT
T	NPTF
F	G

SJ  
SY  
SV  
SYJ  
SZ  
VF  
VP4  
S0700  
VQ  
VQ4  
VQ5  
VQC  
VQC4  
VQZ  
SQ  
VFS  
VFR  
VQ7

# Series VQ5000 Construction

## Plug-in Unit

### Metal seal type

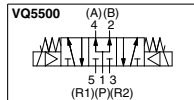
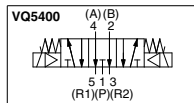
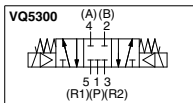
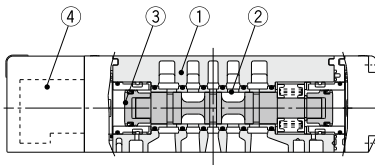
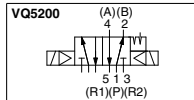
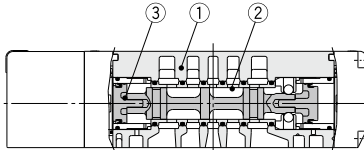
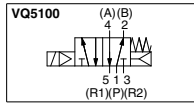
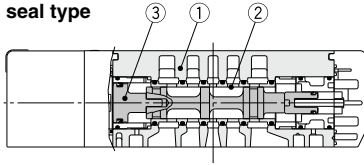

### Rubber seal type

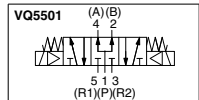
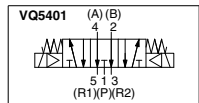
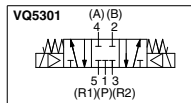
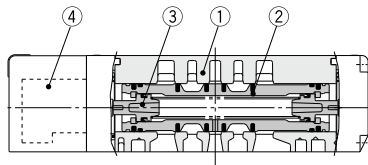
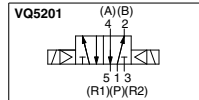
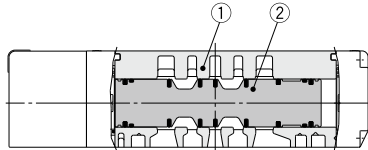
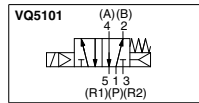
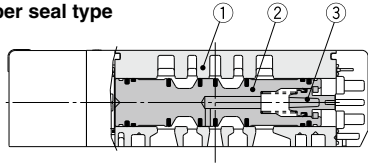

### Component Parts

Number	Description	Material	Note
1	Body	Aluminum die-casted	
2	Spool/Sleeve	Stainless steel	
3	Piston	Resin	

### Replacement Parts

4	Pilot valve assembly	VQZ111P-□-B A E	* Coil rated voltage Example) 24 VDC: 5 A: With A side light B: With B side light E: Without a light (Common for A and B)
---	----------------------	-----------------------	--

### Component Parts

Number	Description	Material	Note
1	Body	Aluminum die-casted	
2	Spool valve	Aluminum, HNBR	
3	Piston	Resin	

### Replacement Parts

4	Pilot valve assembly	VQZ111P-□-B A E	* Coil rated voltage Example) 24 VDC: 5 A: With A side light B: With B side light E: Without a light (Common for A and B)
---	----------------------	-----------------------	--

## Plug Lead Unit

### Metal seal type

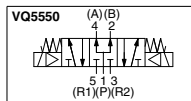
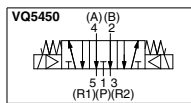
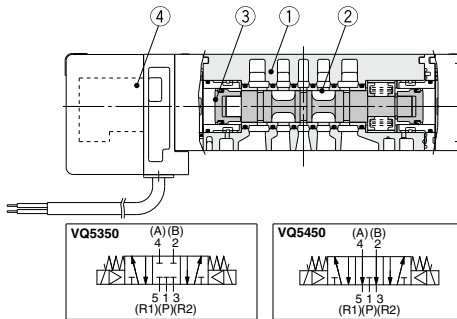
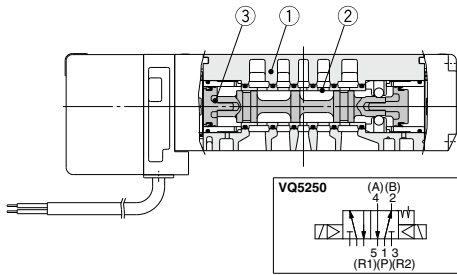
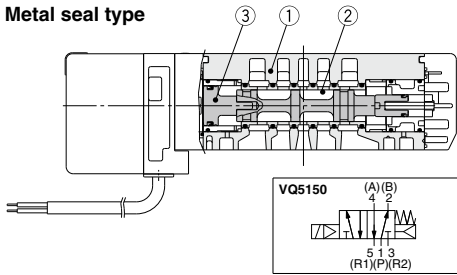

### Rubber seal type

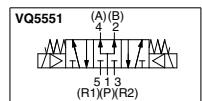
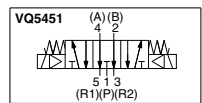
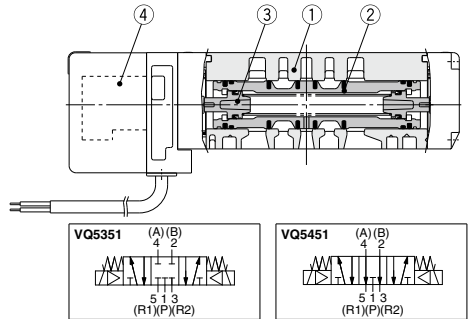
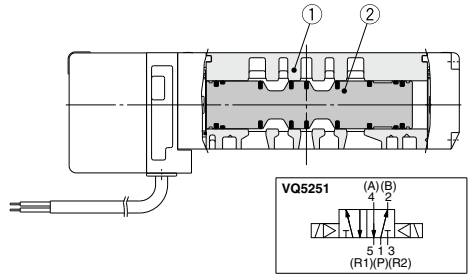
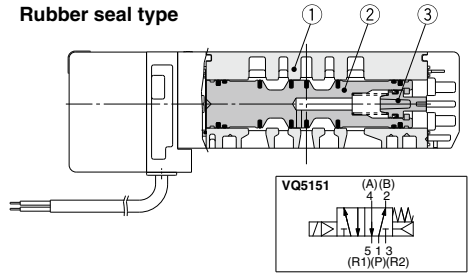

### Component Parts

Number	Description	Material	Note
1	Body	Aluminum die-casted	
2	Spool/Sleeve	Stainless steel	
3	Piston	Resin	

### Replacement Parts

4	Pilot valve assembly	VQZ111P-□-B A E	* Coil rated voltage Example) 24 VDC: 5 A: With A side light B: With B side light E: Without a light (Common for A and B)
---	----------------------	-----------------------	--

### Component Parts

Number	Description	Material	Note
1	Body	Aluminum die-casted	
2	Spool valve	Aluminum, NBR	
3	Piston	Resin	

### Replacement Parts

4	Pilot valve assembly	VQZ111P-□-B A E	* Coil rated voltage Example) 24 VDC: 5 A: With A side light B: With B side light E: Without a light (Common for A and B)
---	----------------------	-----------------------	--

SJ  
SY  
SY  
SV  
SYJ  
SZ  
VF  
VP4  
S0700  
VQ  
VQ4  
VQ5  
VQC  
VQC4  
VQZ  
SQ  
VFS  
VFR  
VQ7

Series VQ5000

# Exploded View of Manifold

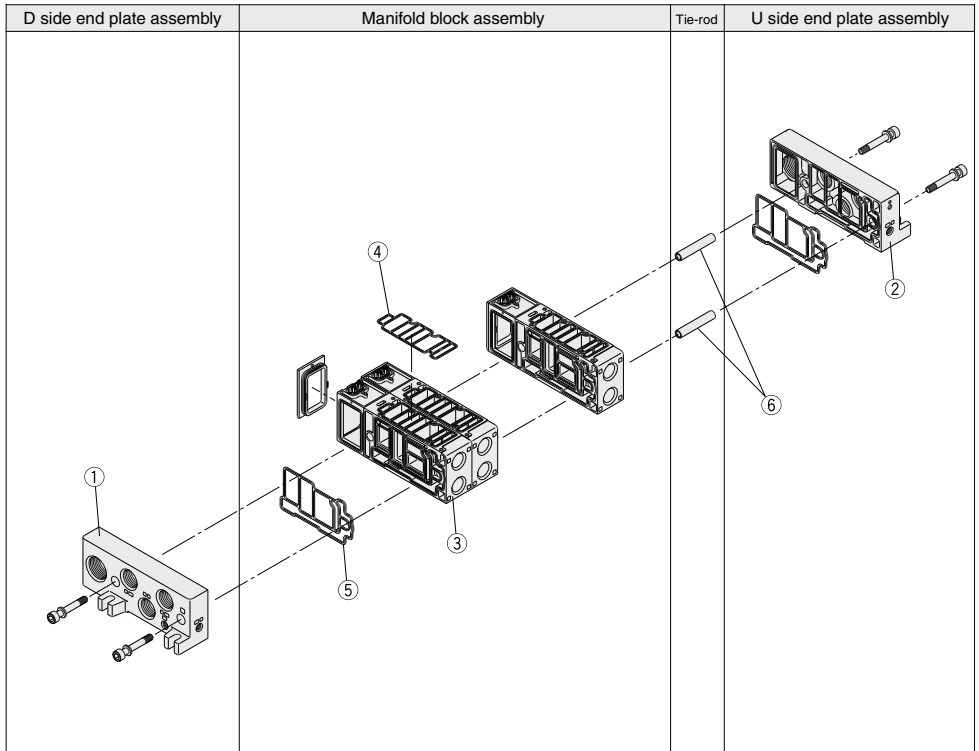

Note) The electrical entry cannot be changed.

The drawing shows a plug-in type.

## <D Side End Plate Assembly>

1. D side end plate assembly part no. (for F, L, S, T & T1 kits)

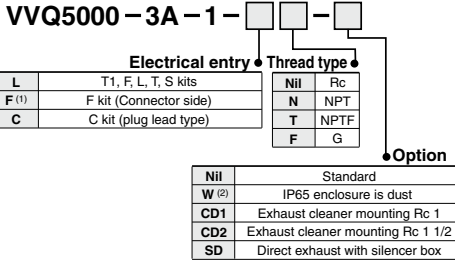

Note 1) D-sub connector for D side: VVQ4000-19A-D is not included. (Order separately)

Note 2) Splashproof specifications is not available for F and T1.

## <U Side End Plate Assembly Part No.>

2. U side end plate assembly part no. (for F, L, S, T & T1 kits)

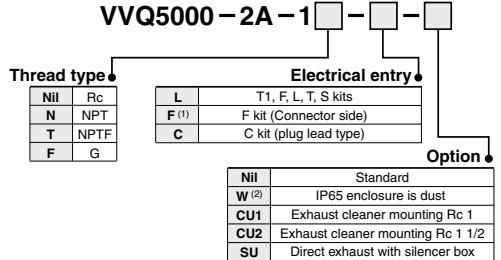

Note 1) D-sub connector for D side: VVQ4000-19A-D is not included. (Order separately)

Note 2) Splashproof specifications is not available for F and T1.

## <Manifold Block Assembly>

3. Manifold block assembly part no.

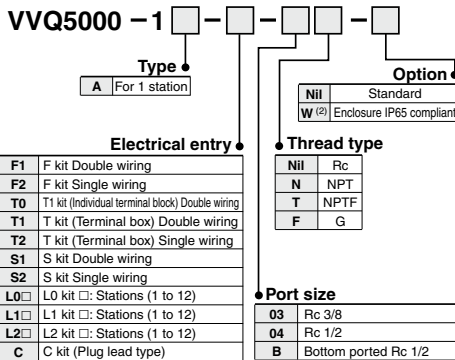

Note 1) Tie-rods (2 pcs.) and lead wire assembly for station addition included.

Note 2) Splashproof specifications is not available for F and T1.

## <Manifold Block Replacement Parts>

### Replacement Parts

No.	Part no.	Description	Material	Number
④	VVQ5000-80A-1	Gasket	NBR	10
⑤	VVQ5000-80A-2	Gasket	NBR	10

Note) Spare parts consist of sets containing 10 pcs. each.

## <D-sub connector assembly>

**VVQ4000 - 19A -** 

Electrical entry	
D	For D side entry
U	For U side entry

6. Tie-rods part no. (2 pcs.)

**VVQ5000 - TR -** 

Stations: 02 to 12

Note) When eliminating manifold stations, order this separately. When increasing manifold stations, it is not necessary to order since tie-rods are included in the manifold block assembly.

## <SI Unit>

SI Unit Part No.

Type	Model symbol	SI unit part no.		Description
		For U side mounting	For D side mounting	
Dedicated output model	F1	EX123U-SUW1	EX123D-SUW1	NKE Corp.: Fieldbus System
	H	EX123U-SUH1	EX123D-SUH1	NKE Corp.: Fieldbus H System
	J1	EX123U-SSL1	EX123D-SSL1	Panasonic Industrial Devices SUNX Co., Ltd.: S-LINK System (16 output points)
	J2	EX123U-SSL2	EX123D-SSL2	Panasonic Industrial Devices SUNX Co., Ltd.: S-LINK System (8 output points)
	Q	EX124U-SDN1	EX124D-SDN1	DeviceNet
	R1	EX124U-SCS1	EX124D-SCS1	OMRON Corp.: CompoBus/S (16 output points, 2 power supply systems)
	R2	EX124U-SCS2	EX124D-SCS2	OMRON Corp.: CompoBus/S (8 output points, 2 power supply systems)
	V	EX124U-SMJ1	EX124D-SMJ1	Mitsubishi Electric Corporation: CC-Link System (2 power supply systems)

## List of Valves, Options, and Mounting Bolts

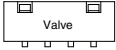
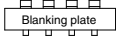
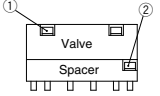
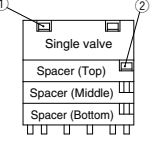
Number of options	Valve and options	Bolt part no.	Qty (pcs)	Note	Option mounting diagram
0	Single valve	AXT 632-25-4 (M4 x 50)	4		
	Blanking plate (VVQ5000-10A- $\frac{1}{5}$ )	AXT 632-25-8 (M4 x 17)	4	For manifold	
1	Valve + Individual SUP spacer (VVQ5000-P- $\frac{1}{5}$ - $\frac{03}{04}$ )	① AXT 632-25-5 (M4 x 82) ② AXT 632-25-10 (M4 x 34)	4 2	For manifold	
	Valve + Individual EXH spacer (VVQ5000-R- $\frac{1}{5}$ - $\frac{03}{04}$ )	① AXT 632-25-5 (M4 x 82) ② AXT 632-25-10 (M4 x 34)	4 2	For manifold	
	Valve + Throttle valve spacer (VVQ5000-20A- $\frac{1}{5}$ )	① AXT 632-25-5 (M4 x 82) ② AXT 632-25-10 (M4 x 34)	4 2	Not necessary when mounting the sub-plate.	
	Valve + Release valve spacer (VVQ5000-24A- $\frac{1}{5}$ D)	① AXT 632-25-5 (M4 x 82) ② AXT 632-25-10 (M4 x 34)	4 2	For manifold	
	Valve + Double check spacer with residual pressure release valve (VVQ5000-25A- $\frac{1}{5}$ )	① AXT 632-25-6 (M4 x 114) ② AXT 632-66-1 (M4 x 64)	4 2	Not necessary when mounting the sub-plate.	
	Valve + SUP stop valve spacer (VVQ5000-37A- $\frac{1}{5}$ )	① AXT 632-25-5 (M4 x 82) ② AXT 632-25-10 (M4 x 34)	4 2	Not necessary when mounting the sub-plate.	
	Valve + Interface regulator (ARBQ5000-00 $\frac{B}{C}$ - $\frac{1}{5}$ )	① AXT 632-25-6 (M4 x 114) ② AXT 632-66-1 (M4 x 64)	4 2	Not necessary when mounting the sub-plate.	
	Blanking plate + SUP stop valve (Top) (Bottom)	① AXT 632-25-4 (M4 x 50)	4	For manifold	
		② AXT 632-25-10 (M4 x 34)	2		
	2	Valve + Individual SUP + Individual EXH (Top) (Bottom) (Bottom) (Top)	① AXT 632-25-6 (M4 x 114) ② AXT 632-25-11 (M4 x 66)	4 2	
Valve + Throttle valve + Individual SUP or Individual EXH (Top) (Bottom) (Bottom) (Top)		① AXT 632-25-6 (M4 x 114) ② AXT 632-25-11 (M4 x 66)	4 2	For manifold * The individual EXH cannot be mounted on the top.	
Valve + SUP stop valve + Individual SUP, Individual EXH or Throttle valve (Bottom)		① AXT 632-25-6 (M4 x 114) ② AXT 632-25-11 (M4 x 66)	4 2	For manifold	
Valve + Double check spacer with + Individual SUP or residual pressure release valve Individual EXH (Top) (Bottom)		① AXT 632-25-7 (M4 x 146) ② AXT 632-66-2 (M4 x 96)	4 2	For manifold	
Valve + Interface regulator + Double check spacer with residual pressure release valve (Bottom)		① AXT 632-25-14 (M4 x 178) ② AXT 632-66-3 (M4 x 128)	4 2	For manifold	
Valve + Interface regulator + Individual SUP, Individual EXH or Throttle valve (Bottom)		① AXT 632-25-7 (M4 x 146) ② AXT 632-66-2 (M4 x 96)	4 2	For manifold * The individual EXH and throttle valve cannot be mounted on the top.	
		Blanking plate + SUP stop valve + Individual SUP (Top) (Bottom)	① AXT 632-25-5 (M4 x 82)	4	For manifold
② AXT 632-25-11 (M4 x 66)			2		
3	Valve + SUP stop valve (Top) + Individual SUP (Middle, Bottom) + Individual EXH (Middle, Bottom)	① AXT 632-25-7 (M4 x 146) ② AXT 632-25-12 (M4 x 98)	4 2	For manifold	
	Valve + Double check spacer with residual pressure release valve (Top) + Individual SUP (Middle, Bottom) + Individual EXH (Middle, Bottom)	① AXT 632-25-14 (M4 x 178) ② AXT 632-66-3 (M4 x 128)	4 2	For manifold	
	Valve + Spacer (Top); Interface regulator Spacer (Middle); Individual SUP or Individual EXH/Throttle valve Spacer (Bottom); Throttle valve*/Individual SUP or Individual EXH	① AXT 632-25-14 (M4 x 178)	4	For manifold * The individual EXH and throttle valve cannot be mounted on the top.	
		② AXT 632-66-3 (M4 x 128)	2		

Note 1) When the SUP stop valve and individual SUP are mounted, the stop valve is mounted on the top of the individual SUP.



# Series VQ5000

## Specific Product Precautions 1

Be sure to read before handling.

Refer to front matter 53 for Safety Instructions and pages 3 to 8 for 3/4/5 Port Solenoid Valve Precautions.

### Manual Override Operation

#### Warning

Since connected equipment will be actuated when the manual override is operated, first confirm that conditions are safe.

Non-locking push type (Tool required) is standard. As a semi-standard specification, slotted locking type (Tool required) is available.

#### Push type (Tool required)

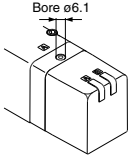

Push down the manual override button with a small screwdriver, etc.  
Release the screwdriver and the manual override will return.

#### Locking type (Tool required) <Semi-standard>

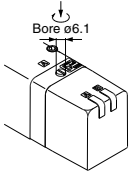

Push down completely on the manual override button with a small screwdriver. While down, turn clockwise 90° to lock it. Turn it counterclockwise to release it.

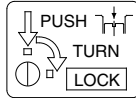

### Mounting of Valves

#### Caution

After confirming the gasket is correctly placed under the valve, securely tighten the bolts with the proper torque shown in the table below.

Proper tightening torque (N·m)

1 to 1.8

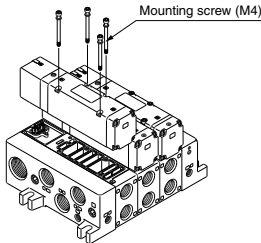

### Lead Wire Connection

#### Caution

#### Plug-in sub-plate (With terminal block)

● If the junction cover ① of the sub-plate is removed, you can see the plug-in type terminal block ② mounted inside the sub-plate.

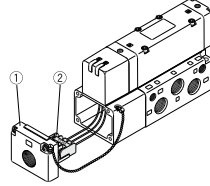

● The terminal block is marked as follows. Connect wiring to each of the power supply terminals.

Model	Terminal block marking	A	COM	B	⎓
VQ510 <sup>0</sup>		A side	COM	—	—
VQ520 <sup>0</sup>		A side	COM	B side	—
VQ530 <sup>0</sup>		A side	COM	B side	—

Note 1) There is no polarity. It can also be used as -COM.

Note 2) The sub-plate is double wired even for the VQ510<sup>0</sup>.

● Applicable terminal 1.25-3s, 1.25Y-3, 1.25Y-3N, 1.25Y-3.5.

#### Plug lead: Grommet type

Make connections to each corresponding wire.

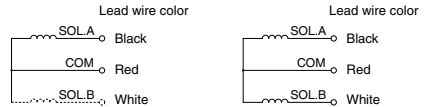

#### Single solenoid

#### Double solenoid

	Single solenoid	Double solenoid
Standard		
Enclosure IP65 compliant		

Note) There is no polarity.

SJ  
SY  
SV  
SYJ  
SZ  
VF  
VP4  
S0700  
VQ  
VQ4  
VQ5  
VQC  
VQC4  
VQZ  
SQ  
VFS  
VFR  
VQ7



# Series VQ5000

## Specific Product Precautions 2

Be sure to read before handling.

Refer to front matter 53 for Safety Instructions and pages 3 to 8 for 3/4/5 Port Solenoid Valve Precautions.

### Installation and Removal of Light Cover

#### ⚠ Caution

##### Installation/Removal of light cover

###### ● Removal

To remove the pilot cover pull it straight off. If it is pulled off at an angle, the pilot valve may be damaged or the protective O-ring may be scratched.

###### ● Installation

Place the cover straight over the pilot assembly so that the pilot valve is not touched, and push it until the cover hook locks without twisting the protective O-ring. (When pushed in, the hook opens and locks automatically.)

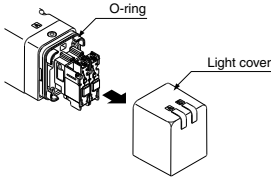

### Replacement of Pilot Valve

#### ⚠ Caution

###### ● Removal

1. Remove the mounting screw that holds the pilot valve using a small screwdriver.

###### ● Installation

1. After confirming the gasket is correctly placed under the valve, securely tighten the bolts with the proper torque shown in the table below.

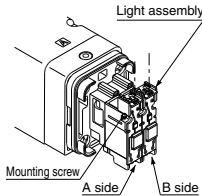

Proper tightening torque (N·m)

0.1 to 0.13

Note) The light circuit boards: A side is orange and the B side is green. It must be mounted on the pilot valve in accordance with the mounting indicators.

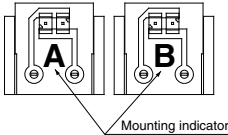

### For Plug Lead Type

#### Attaching and detaching connectors

- To attach a connector, hold the lever and connector unit between your fingers and insert straight onto the pins of the solenoid valve so that the lever's pawl is pushed into the groove and locks.
- To detach a connector, remove the pawl from the groove by pushing the lever downward with your thumb, and pull the connector straight out.

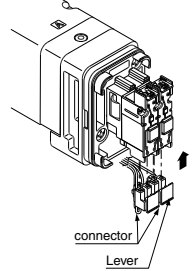

Note) Do not pull on the lead wires with excessive force. This can cause faulty and/or broken contacts.

### Internal Wiring Specifications

#### ⚠ Caution

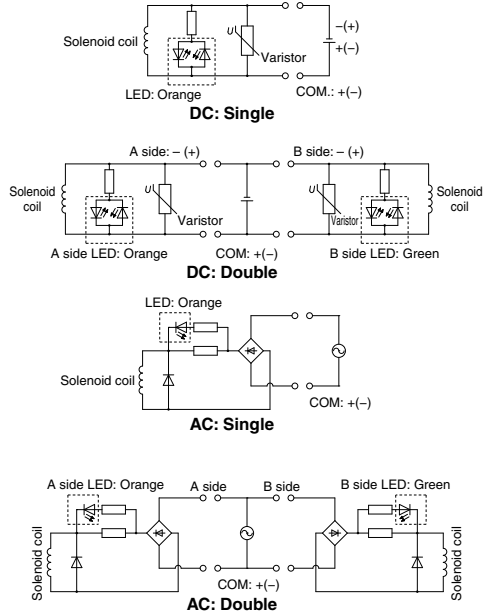

### How to Calculate the Flow Rate

For obtaining the flow rate, refer to front matters 42 to 45.

#### ■ Trademark Information

DeviceNet™ is a trademark of ODVA.