

Quick Exhaust Valve

AQ Series

RoHS

Excellent exhaust characteristics

Large flow capacity

Compact and lightweight

A wide selection of models

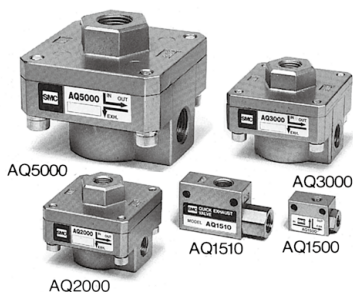

Model

Model	Port size	Sonic conductance dm ³ /(s·bar)		Critical pressure ratio		Weight (g)
		IN → OUT	OUT → EXH	IN → OUT	OUT → EXH	
AQ1500-M5	M5 x 0.8	0.4	0.56	0.35	0.3	25
AQ1510-01	1/8	0.8	1.16			45
AQ2000-01	1/8	5	5	0.45	0.35	110
AQ2000-02	1/4	7	8			105
AQ3000-02	1/4	8	8.4			215
AQ3000-03	3/8	12	14			205
AQ5000-04	1/2	21	23			690
AQ5000-06	3/4	27	36			650

Specifications

Fluid		Air
Proof pressure		1.5 MPa
Max. operating pressure	AQ15□0	0.7 MPa
	AQ2000 to 5000	1 MPa
Min. operating pressure	AQ15□0	0.1 MPa
	AQ2000 to 5000	0.05 MPa
Ambient and fluid temperature		-5 to 60°C (No freezing)

Symbol

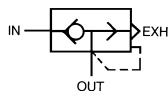

How to Order

AQ 2 0 0 0 - □ 02 - □

Standard size

1	1/8
2	1/4
3	3/8
5	3/4

Type

Symbol	Type	Applicable model
0	Diaphragm	AQ2 to AQ5
5	Lip	AQ1 Only

Standard

0	M5 x 0.8
1	1/8

Note) *AQ15□0" only

Thread type

Nil	Metric thread (M5)
N	Rc
N	NPT
F	G

Option

Nil	Standard (-5 to 60°C)
H	High temperature (-5 to 80°C)
L	Low temperature (-30 to 60°C)

Note) AQ1500 and AQ1510 are not available.

Port size

Port size	Applicable series
M5	M5 x 0.8
01	1/8
02	1/4
03	3/8
04	1/2
06	3/4

Construction

AQ1500/1510

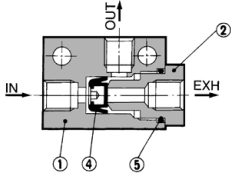

AQ2000/3000/5000

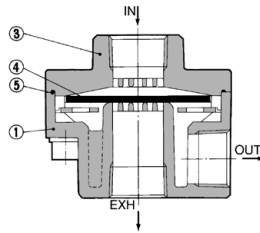

Component Parts

No.	Description	Material/Model		
		AQ1500	AQ1510	AQ2000, 3000, 5000
1	Body	Zinc die-casted	Zinc die-casted	Aluminum die-casted
2	Guide	Brass	Brass	—
3	Cover	—	—	Aluminum die-casted

Replacement Parts

No.	Description	Material	Part no.				
			AQ1500	AQ1510	AQ2000	AQ3000	AQ5000
4	Valve	NBR	30083	30093	30073	30053	30063
5	O-ring	NBR	KA00327 9 x 7 x 1	KA00476 JISB2401P-7	CA40-1601	CA50-1602	30066

Dimensions

AQ1500/1510

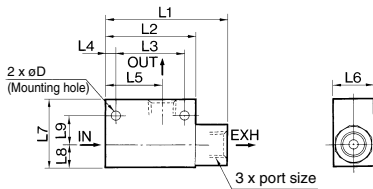

Model	Port size	L1	L2	L3	L4	L5	L6	L7	L8	L9	D
AQ1500	M5 x 0.8	23	20	14	3	12.5	12	15	5.5	6.5	3.1
AQ1510	1/8	45	33	25	4	21	15	25	8	11	4.3

AQ2000/3000/5000

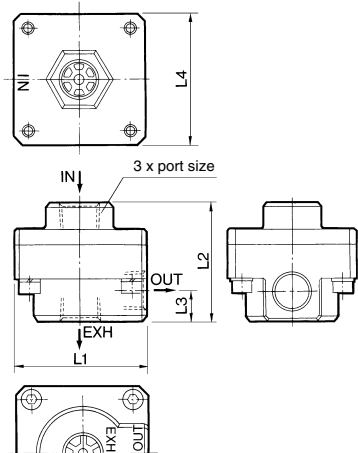

Model	Port size	L1	L2	L3	L4
AQ2000	1/8, 1/4	45	40	10	45
AQ3000	1/4, 3/8	56	50	12.5	56
AQ5000	1/2, 3/4	85	75	18	85

⚠ Specific Product Precautions

Be sure to read this before handling the products. Refer to back page 50 for Safety Instructions and pages 543 to 546 for Flow Control Equipment Precautions.

Design/Selection

⚠ Caution

1. In the following cases, insufficient exhaust or vibration may cause noise.

- (a) With residual pressure or back pressure on the IN side.
- (b) When the differential pressure between the IN and OUT sides is smaller than the minimum operating pressure.
- (c) When the effective area of the IN side piping of AQ, or the solenoid valve, is smaller than AQ.

2. In the case of applications where the IN side is constantly pressurized, there is a risk of exhaust failure.

Compared to the state where the IN side is open to the atmosphere (no pressurization), the differential pressure that operate the valve become larger, which may cause exhaust failure.

AS-F

TMH

ASD

AS

AS-FE

KE

AS-FG

AS-FP

AS-FM

AS-D

AS-T

ASP

ASN

AQ

ASV

AK

VCHC

ASR
ASQ

Quick Exhaust Valve with One-touch Fittings

RoHS

AQ240F/340F Series



With exhaust port fitting

With silencer

Symbol

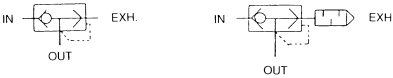

With exhaust port fitting

With silencer

How to Order

AQ 2 4 0 F - 06 - 06

Quick exhaust valve

Body size

2	M5
3	1/8

In-line type

Exhaust port

00	With silencer
04	Applicable tubing O.D. $\phi 4$
06	Applicable tubing O.D. $\phi 6$
07	Applicable tubing O.D. $\phi 1/4"$

IN, OUT port applicable tubing O.D.

04	$\phi 4$
06	$\phi 6$
07	$\phi 1/4"$

With One-touch fittings

Note) Brass parts are all electroless nickel plated.

Specific Product Precautions

Be sure to read this before handling the products.
Refer to back page 50 for Safety Instructions and pages 543 to 546 for Flow Control Equipment Precautions.

Design/Selection

Caution

1. In the following cases, insufficient exhaust or vibration may cause noise.

- With residual pressure or back pressure on the IN side.
- When the differential pressure between the IN and OUT sides is smaller than the minimum operating pressure.
- When the effective area of the IN side piping of AQ, or the solenoid valve, is smaller than AQ.

2. In the case of applications where the IN side is constantly pressurized, there is a risk of exhaust failure.

Compared to the state where the IN side is open to the atmosphere (no pressurization), the differential pressure that operate the valve become larger, which may cause exhaust failure.

Space-saving

Rectilinear IN-OUT tubing connections

- With One-touch fittings and silencer
- With silencer
- Lightweight (Resin body)

Specifications

Fluid	Air
Proof pressure	1.5 MPa
Max. operating pressure	1 MPa
Min. operating pressure	0.1 MPa
Ambient and fluid temperature	-5 to 60°C (No freezing)
Applicable tubing material ⁽¹⁾	Nylon, Soft nylon, Polyurethane

Note 1) Use caution regarding the max. operating pressure when soft nylon or polyurethane tubing is used. (Refer to pages 464 and 465 for details.)

Model

Model	Applicable tubing O.D.			Sonic conductance dm ³ /(s·bar)		Critical pressure ratio	
	4	6	1/4"	IN → OUT	OUT → EXH.	IN → OUT	OUT → EXH.
AQ240F-04-□	●			0.34	0.5	0.15	0.15
AQ240F-06-□		●		0.48	0.54		
AQ340F-06-□			●	0.8	0.8		
AQ240F-07-□			●	0.48	0.54		
AQ340F-07-□			●	0.8	0.8		

Circuit

With silencer

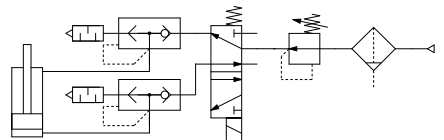

With exhaust port fitting

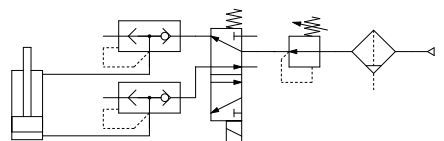

Construction

With silencer

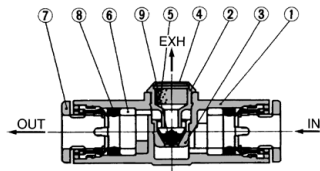

No.	Description	Material	Note
1	Body A	PBT	
2	Seat ring	Brass	Electroless nickel plated
3	Valve seat	Brass	Electroless nickel plated
4	Silencer cover	Stainless steel 304	
5	Silencer	PVA sponge	
6	Spacer	POM	
7	Cassette	—	
8	Seal	NBR	
9	Valve	HNBR	

With exhaust port fitting

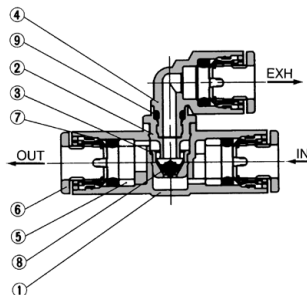

No.	Description	Material	Note
1	Body A	PBT	
2	Seat ring	Brass	Electroless nickel plated
3	Valve seat	Brass	Electroless nickel plated
4	Elbow union body	PBT	
5	Spacer	POM	
6	Cassette	—	
7	Seal	NBR	
8	Valve	HNBR	
9	O-ring	NBR	

Dimensions

With silencer

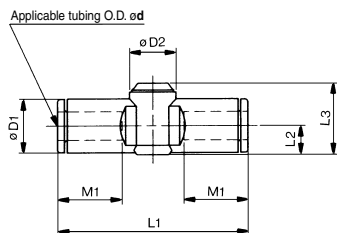

Model	Tubing O.D. ød	D1	D2	L1	L2	L3	M1	Weight (g)
AQ240F-04-00	4	9.3	10.0	39.2	5.2	14.3	12.9	5
AQ240F-06-00	6	11.6	10.0	40.7	6.2	15.4	13.7	6
AQ340F-06-00	6	11.6	11.8	44.8	6.3	19.5	13.7	11
AQ240F-07-00	1/4"	12	10.0	40.7	6.2	15.4	13.7	6
AQ340F-07-00	1/4"	13.2	11.8	52.2	7.1	20.3	16.8	11

With exhaust port fitting

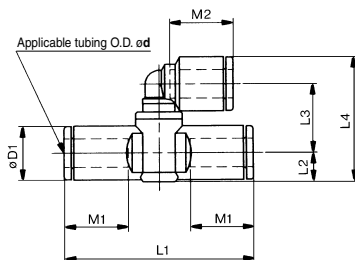

Model	Tubing O.D. ød	D1	L1	L2	L3	L4	M1	M2	Weight (g)
AQ240F-04-04	4	9.3	39.2	5.2	13.7	23.5	12.9	12.9	6
AQ240F-06-06	6	11.6	40.7	6.2	14.7	26.7	13.7	13.7	8
AQ340F-06-06	6	11.6	44.8	6.3	19.6	31.7	13.7	13.7	13
AQ240F-07-07	1/4"	12	40.7	6.2	15.1	27.3	13.7	13.7	8
AQ340F-07-07	1/4"	13.2	52.2	7.1	20.0	33.1	16.8	13.7	13

AS-F
TMH
ASD
AS
AS-FE
KE
AS-FG
AS-FP
AS-FM
AS-D
AS-T
ASP
ASN
AQ
ASV
AK
VCHC
ASR
ASQ