

4-Port Solenoid Valve Cassette Type Manifold

SJ1000/2000/3000 Series

Rubber Seal

The connection cable and various units for PLC connection in PC wiring systems have been discontinued by the manufacturer. Therefore, while they can no longer be provided, the valve manifold (manifold with built-in valves) can still be ordered. For details, refer to the [Web Catalog](#).



Valve width
A **6.5 mm** type has been added.

SJ1000, SJ2000, and SJ3000 valves can be mounted together.

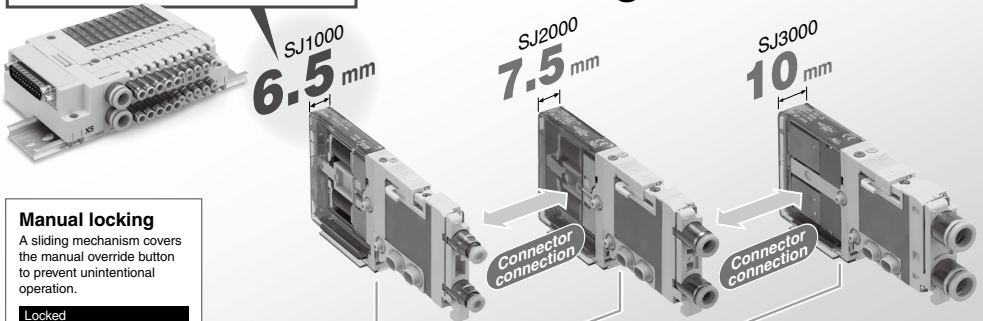

Manual locking
A sliding mechanism covers the manual override button to prevent unintentional operation.

Locked

Unlocked

A low-profile SUP/ EXH block has been added.
(Made to order)

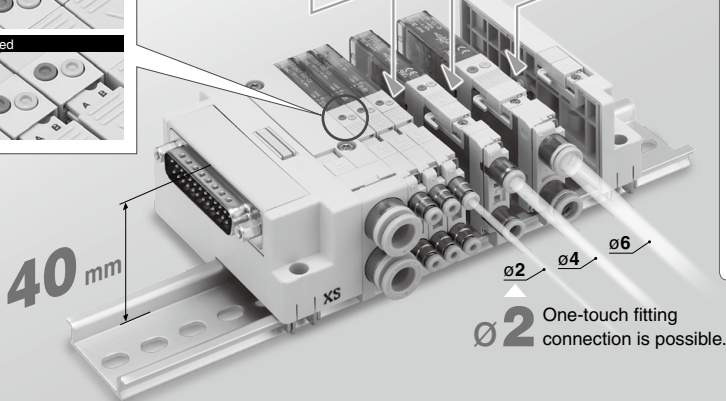

Non plug-in type
Individual wiring manifold



Vacuum release valve with restrictor
Suction and release can be controlled with a single unit.

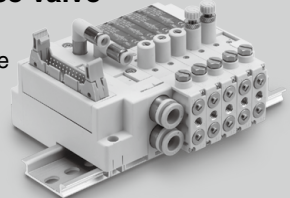

● Power consumption

- 0.15 W*¹ (SJ3000 with power-saving circuit)
- 0.23 W*¹ (SJ1000/2000 with power-saving circuit)
- *1 Refer to page 379 for details.

● Connector type (Card edge type)

SJ1000, SJ2000, and SJ3000 series valves can be mounted together.

- Easily increase or decrease the number of stations and easily replace valves
- The 34-pin connector allows for up to 16 stations with double solenoids or 32 stations with single solenoids.

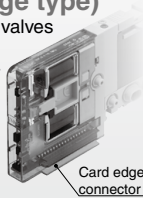

● Non plug-in individual wiring compliant

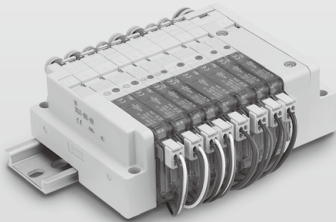

● The manifold uses halogen-free lead wires.

● Plug-in cable type manifold

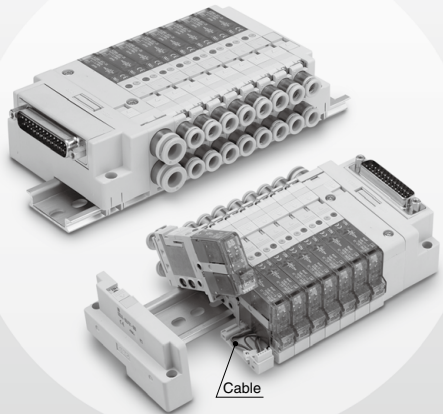

Piping variations

With One-touch fittings

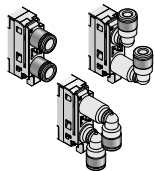

Threaded type

The threaded type is not available for the 1(P) or 3/5(E) ports.



Fittings are replaceable.

Fittings (including type and size) can be easily changed by removing a clip.

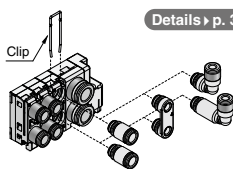

Details ▶ p. 381

With switch (Connector type)

- It is possible to shut off the signal of each valve individually.
- Manual operation is possible by switching the valve OFF, even if it is in an energized state.

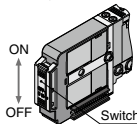

The valve coil is kept in a deenergized state even when there is an electric signal from the manifold side connector, and this enables manifold operation.

Manual locking

A sliding mechanism covers the manual override button to prevent unintentional operation.

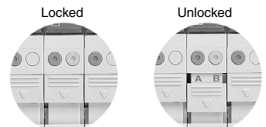

Valve connection mechanism

Connection between valves can be secured using the valve lock switch. Connection can be confirmed by checking to see whether the connection hook is inserted into the connection groove of the adjacent valve.

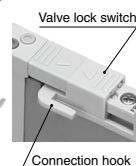
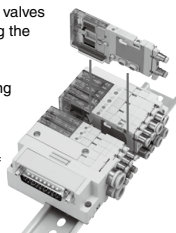

The word "FREE" can be seen when connection is unlocked.

Connector mounting direction

Connector mounting direction can be changed by sliding the switch.

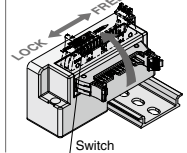

Light indication

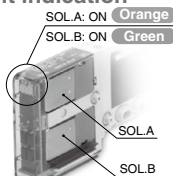

Type of manual override

Non-locking push type

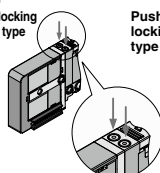

Push-turn locking slotted type

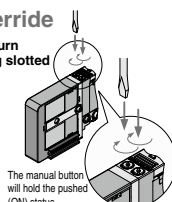

Slide locking type

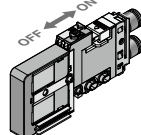

A side manual (Blue)

B side manual (Yellow)

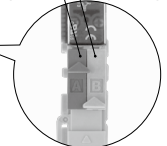

4-Port Solenoid Valve Cassette Type Manifold SJ1000/2000/3000 Series

D-sub connector

SJ1000

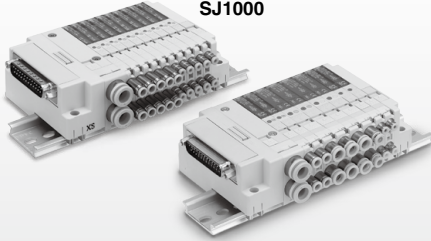

EX180 Integrated type (for output) serial transmission system

* Connector type only

SJ1000

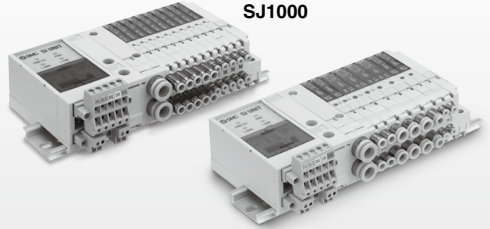

Flat ribbon cable

SJ1000

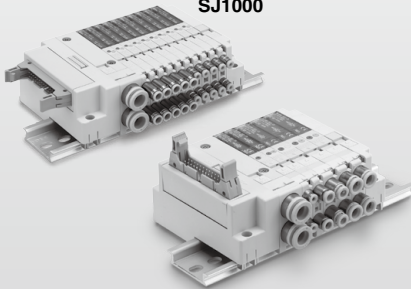

EX510 Gateway type serial transmission system

* Connector type only

SJ1000

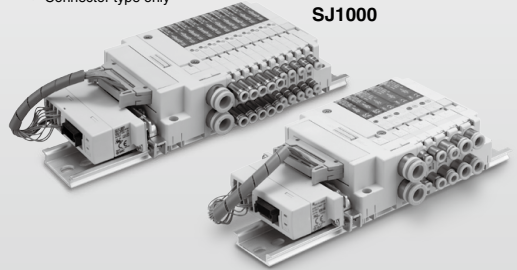

EX180 Integrated type (for output) serial transmission system*1

*1 Connector type only

- **CC-Link (32 outputs), DeviceNet® (16 or 32 outputs)**
- The connector allows for easy attaching/detaching of the SI unit and wiring.
- Separated valve power unit and transmission power unit/Improved maintenance safety
- Select between a T-branch or a straight type communication connector

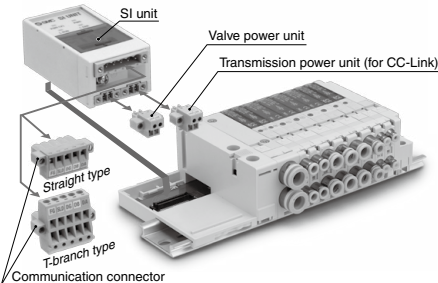

For DeviceNet®, a transmission power unit exists in the communication connector side of the T-branch or straight type.

EX510 Gateway type serial transmission system*1

*1 Connector type only

- **Max. 128 points (Input 64 points/ Output 64 points)**
- All wires can be plugged into the connector units.
- **CC-Link, DeviceNet®, and PROFIBUS-DP compliant**

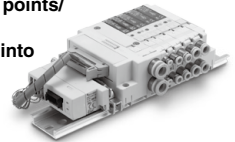

System configuration

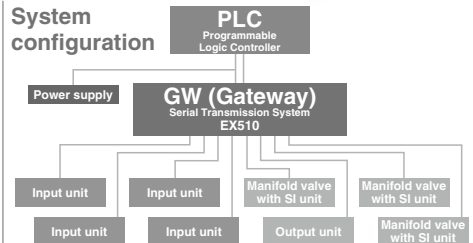

4-position dual 3-port valve

- 3-port valves integrated into a single valve
- It is possible to control the 4(A) and 2(B) ports individually.
- Can be mounted on the same manifold as a 4-port valve
- 3 types of combinations are available.
- A label with the same colors as the manual override is attached to show the functions of the A side and B side.

A side	B side	Symbol
N.C. valve	N.C. valve	
N.O. valve	N.O. valve	
N.C. valve	N.O. valve	

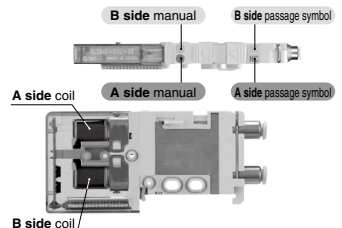

4-Port Solenoid Valve Cassette Type Manifold SJ1000/2000/3000 Series

Regulator block Details ▶ p. 348

This is a regulator block with the same width (10 mm) as the SJ3000. Pressure supplied from the D side is used to reduce pressure in the manifold. The U side valves are all depressurized by the regulator block.

Regulator block

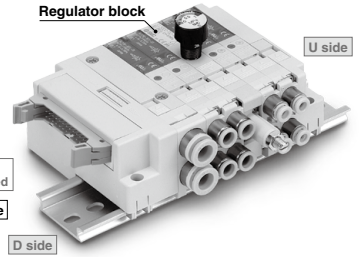

● Pneumatic circuit (Example of a regulator block installation)

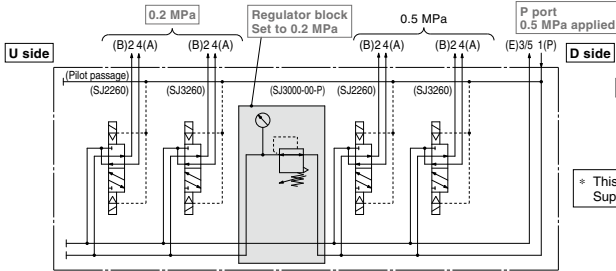

• This reduces supply pressure from the D side of the manifold. Supply pressure from the U side cannot be reduced.

● Both the pressure gauge mounting position and the method of operating the pressure adjustment screw can be selected.

SJ3000-00-P(H)

SJ3000-01-P(H)

SJ3000-M1-P(H)

With manual operation of the pressure adjustment screw

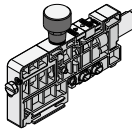

Pressure gauge, top mounting

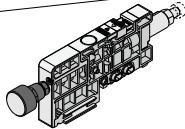

Pressure gauge, side mounting

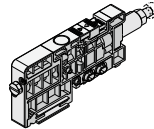

Without pressure gauge

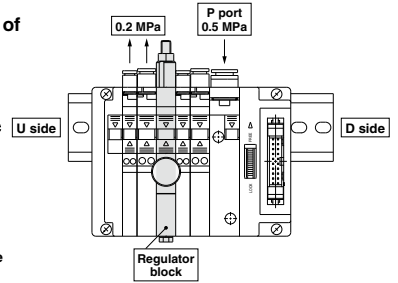

Intermediate connector block assembly Details ▶ p. 354

This connector block can be used by inserting it into the middle of the manifold. It can be used, for example, when you wish to separate electrical control of valves in the same manifold or when the number of control points is insufficient.

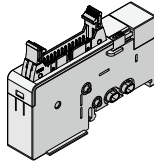

Intermediate connector block assembly

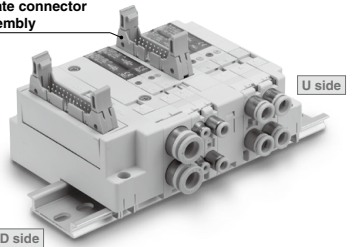

● Intermediate connector block assembly wiring example

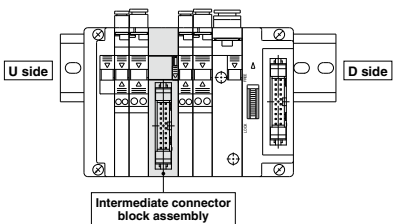
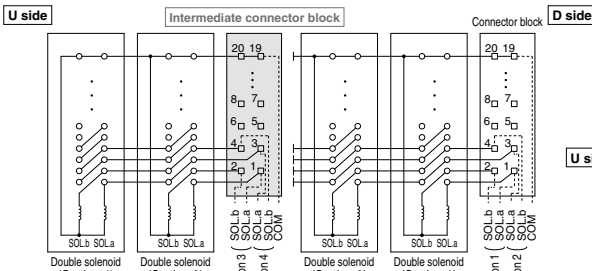

• The U side solenoid valves can be controlled from the position where the intermediate connector block assembly is mounted.

SUP/EXH block assembly with regulator and pressure switch Details ▶ p. 350

This pressure regulator is intended to adjust the SUP pressure of the manifold. Additionally, a pressure switch and pressure gauge can be mounted on it.

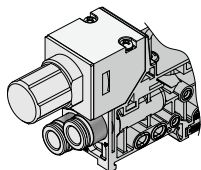

Lateral knob

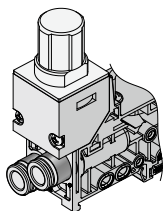

Upward knob

SUP/EXH block assembly with regulator and pressure switch

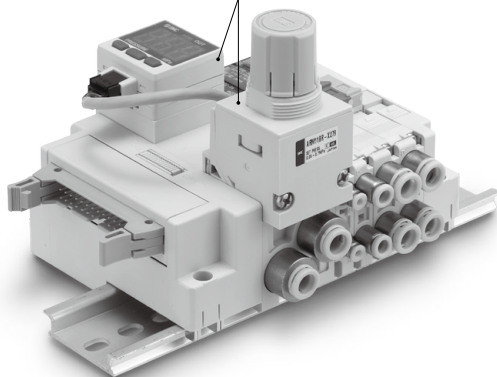

Valve with speed controller Details ▶ p. 350

As a speed controller is built into this valve, the cylinder speed can be adjusted on the valve side. 2 types, meter-in and meter-out, are provided.

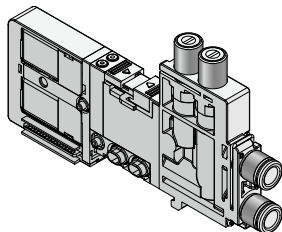

Valve with speed controller
Meter-in: Black
Meter-out: Silver

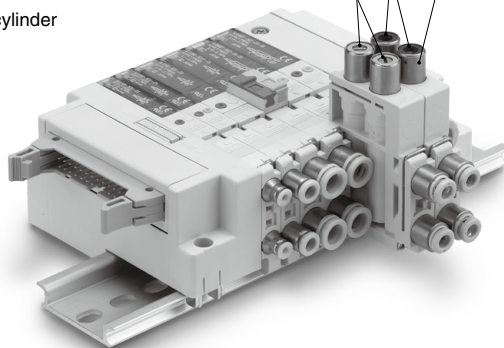

Pneumatic circuit (Installation example of a SUP/EXH block assembly with regulator and pressure switch and a valve with speed controller)

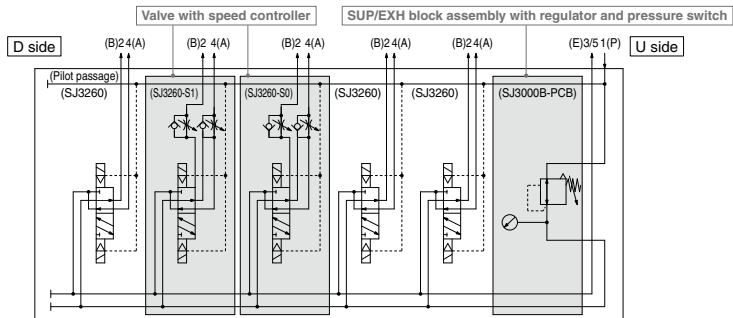

4-Port Solenoid Valve Cassette Type Manifold *SJ1000/2000/3000 Series*

Low-profile SUP/EXH block assembly Details ▶ p. 356 (Made to order)

The width dimension of the SUP/EXH block is only 10.2 mm, smaller than the 15.5 mm width of the standard product, which allows for the length of the entire manifold to be reduced.

	Width	Reduction
Low-profile SUP/EXH block assembly	10.2	5.3
Standard product	15.5	—

[mm]

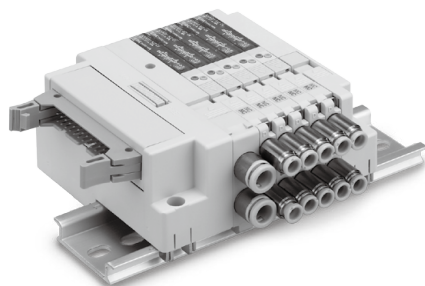
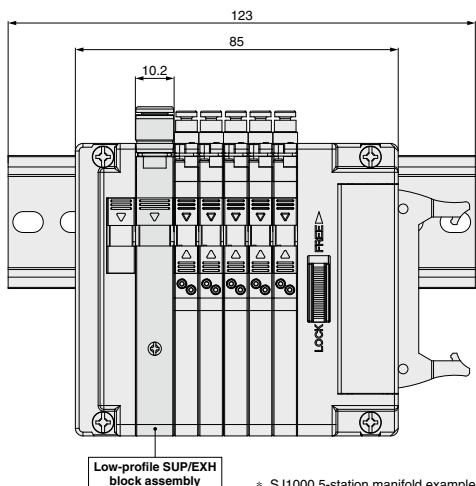
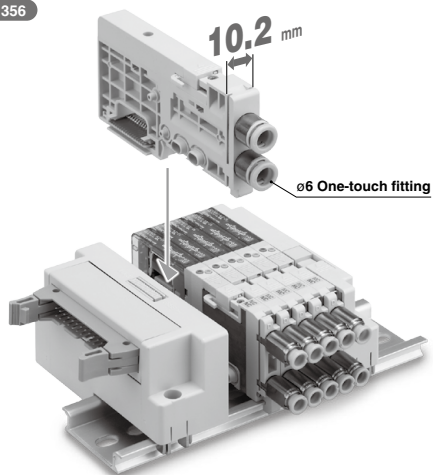

Flow Rate Characteristics

Series	Port size		Flow rate characteristics	
	1 (P) 3/5 (E)	4, 2 (A, B)	1 → 4/2 (P → A/B) C [dm ³ /(s·bar)]	4/2 → 3/5 (A/B → E) C [dm ³ /(s·bar)]
SJ1000	C6	C2	0.12	0.13
		C4	0.26	0.30
SJ2000	C6	C2	0.13	0.13
		C4	0.30	0.34
		M3	0.18	0.20
SJ3000	C6	C2	0.13	0.14
		C4	0.38	0.45
		C6	0.45	0.51
		M5	0.40	0.45

* The values are for an individually operated 2-position type manifold base with 5 stations.

Vacuum Release Valve with Restrictor

With 2 built-in spool valves
Vacuum suction and release can be
controlled with a single valve.

Plug-in
Connector connection
Cable connection

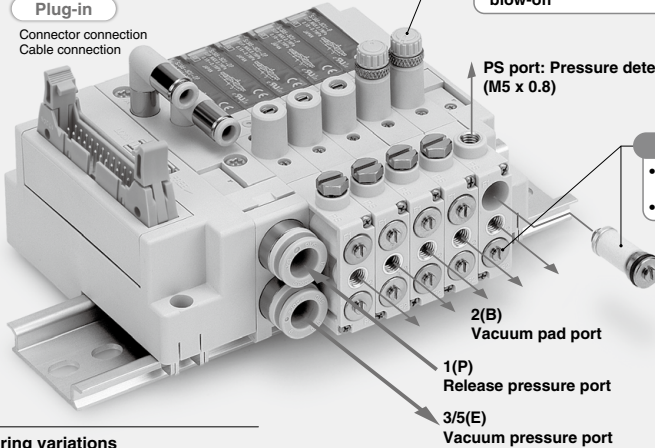

Restrictor

- Flow rate adjustment of release air
- Prevents workpiece blow-off

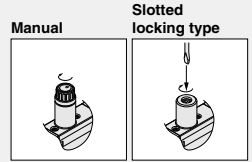

Filter

- Eliminates foreign matter on the vacuum and release sides
- Replaceable

PS port: Pressure detection port
(M5 x 0.8)

2(B)
Vacuum pad port

1(P)
Release pressure port

3/5(E)
Vacuum pressure port

Wiring variations

- <Connector connection>
- D-sub connector
 - Serial (EX180)
 - Flat ribbon cable
 - Serial (EX510)
- <Cable connection>
- D-sub connector
 - Flat ribbon cable

Non plug-in

- Individual wiring

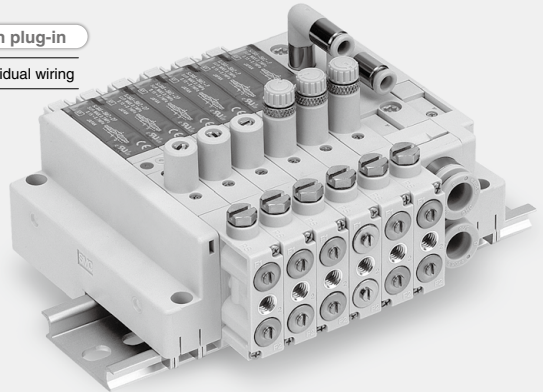

SJ3A6 Series

- **Power consumption:** 0.15 W^{*1} (with power-saving circuit)
- **Width:** 10 mm (same as the SJ3000 series)
- **Equipped with restrictor to enable flow rate adjustment of release air**
- **Replaceable filters are built-in on the vacuum and release sides.**
- **Equipped with a pressure detection port which allows for the connection of a pressure switch, etc.**
- **Can be combined with 4-port solenoid valves, as well as SJ1000, 2000, and 3000 series valves (Special order)**
(Please contact SMC for details.)
- **Enables 2-system pressure switching where the 1(P) port and the 3/5(E) port are set to different positive pressures**
(In this case, flow can be adjusted on the P-port side only.)



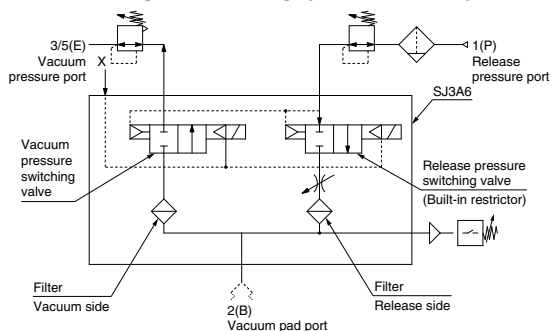

*1 Refer to page 379 for details.

Adsorbing and Transferring System Circuit Example

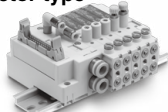
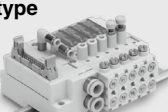

Manifold Variations

4-Port Solenoid Valve SJ1000/2000/3000 Series Vacuum Release Valve with Restrictor SJ3A6 Series

Manifold type			Connection				
			Parallel wiring		Serial transmission		Individual wiring
Item	D-sub connector	Flat ribbon cable	EX180 (For output)	EX510 (Gateway type)			
	4-port solenoid valve	Plug-in 	Connector type SJ1000/2000/3000 SS5J1/2/3-60□	● p. 290	● p. 290	● p. 312	● p. 322
Cable type 		SJ2000/3000 SS5J2/3-60L□	● p. 292	● p. 292	—	—	—
Non plug-in 		SJ2000/3000 SS5J2/3-60□	—	—	—	—	● p. 337
Vacuum release valve with restrictor	Plug-in 	Connector type SJ3A6 SS3J3-V60□	● p. 366	● p. 366	● p. 366	● p. 366	● ^{#1} p. 367
	Cable type 	SJ3A6 SS3J3-V60L□	● p. 368	● p. 368	—	—	—
	Non plug-in 	SJ3A6 SS3J3-V60□	—	—	—	—	● p. 373

*1 A linkage-printed circuit board is built into individual wiring valves so as to allow for use in combination with the plug-in types.

*2 Specify the required specifications on the manifold specification sheet.

*3 All single wiring or all double wiring can be specified.

*4 The vacuum release valve can only use double wiring.

*5 Only the SJ3000 size is available.

*6 Adding 1 additional station is possible up to the max. number of stations.

*7 Only the SJ2000 and SJ3000 sizes are available.

Manifold options												Solenoid valve specifications			
Mixed wiring Single/Double	Mixed type M60 SJ1000/2000/3000	Block disk assembly/ Different pressure pneumatic circuit diagram	Blanking block assembly	Dual flow fitting	Regulator block	SUP/EXH block assembly with regulator and pressure switch	Valve with speed controller	Intermediate connector block assembly	Increase of manifold stations	Low-profile SUP/EXH block assembly	Voltage suppressor			Main valve fluororubber specification	
											Non-polar	+/- common Polar	With power-saving circuit	With individual switch	
● ^{*2}	● p. 290	● p. 344	● p. 345	● ^{*5} p. 347	● p. 348	● p. 350	● ^{*5} p. 350	● p. 354	● p. 333	● p. 356	● ^{*7}	●	●	● ^{*7}	● ^{*7} p. 355
— ^{*3}	—	● p. 344	● p. 345	● ^{*5} p. 347	—	—	● ^{*5} p. 350	—	● ^{*6} p. 334	● p. 356	—	●	●	—	● p. 355
●	● ^{*7} p. 336	● p. 344	● p. 345	● ^{*5} p. 347	● p. 348	● p. 350	● ^{*5} p. 350	—	● p. 333	● p. 356	—	●	—	—	● p. 355
— ^{*4}	—	● p. 344	● p. 345	—	—	—	—	● p. 354	● p. 333	● p. 356	●	●	●	●	● p. 355
— ^{*4}	—	● p. 344	● p. 345	—	—	—	—	—	● ^{*6} p. 334	● p. 356	—	●	●	—	● p. 355
— ^{*4}	—	● p. 344	● p. 345	—	—	—	—	—	● p. 333	● p. 356	—	●	—	—	● p. 355

CONTENTS

Manifold Variations p. 274

4-Port Solenoid Valve *SJ1000/2000/3000 Series*

Common Specifications p. 278

Construction p. 281

Plug-in Connector Type Manifold/Cable Type Manifold

p. 289

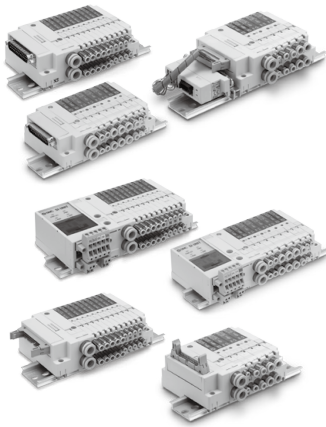

D-sub Connector/Flat Ribbon Cable

How to Order: Connector Type p. 290

How to Order: Cable Type p. 292

Manifold Electrical Wiring: Connector Type, Cable Type p. 294

Dimensions: Connector Type, Cable Type p. 296

EX180 Integrated Type (For Output) Serial Transmission System

How to Order: Connector Type p. 312

Dimensions: Connector Type p. 314

EX510 Gateway Type Serial Transmission System

How to Order: Connector Type p. 322

Dimensions: Connector Type p. 324

Manifold Exploded View: Connector Type, Cable Type p. 331, 332

How to Increase Manifold Stations: Connector Type, Cable Type ... p. 333, 334

Non Plug-in Individual Wiring Manifold

p. 335



Individual Wiring

How to Order p. 336

Dimensions p. 338

Manifold Exploded View: Individual Wiring p. 343

Manifold Options p. 344

Made to Order p. 355

Vacuum Release Valve with Restrictor *SJ3A6 Series* **p. 363**

Common Specifications	p. 364
Construction/Circuit Example	p. 365

Plug-in Connector Type Manifold/Cable Type Manifold

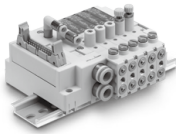

D-sub Connector/Flat Ribbon Cable/Serial Wiring (EX180/EX510)

How to Order: Connector Type	p. 366
How to Order: Cable Type	p. 368
Dimensions: Connector Type, Cable Type	p. 370

Non Plug-in Individual Wiring Manifold

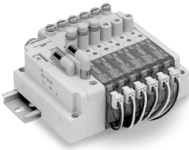

Individual Wiring

How to Order	p. 372
Dimensions	p. 374

Manifold Exploded View: Connector Type, Cable Type, Individual Wiring	p. 375, 376
Specific Product Precautions	p. 377

4-Port Solenoid Valve

SJ1000/2000/3000 Series

Common Specifications

Manifold Specifications

Model*1	D-sub connector		Flat ribbon cable		Serial wiring		Individual wiring
	Type 60F (Connector type/ Cable type)	Type 60P (Connector type/ Cable type)	Type 60PG (Connector type/ Cable type)	Type 60PH (Connector type/ Cable type)	Type 60S□ EX180/ (Connector type)	Type 60S6B EX510/ (Connector type)	Type 60
Manifold type	Plug-in, Connector type/Cable type				Plug-in, Connector type		Non plug-in
1(P: SUP), 3/5(E: EXH)	Common SUP, EXH						
Valve stations	Connector type: 1 to 24 stations Cable type: 2 to 20 stations		1 to 18 stations (Type PG)	1 to 8 stations	1 to 32 stations	1 to 16 stations	1 to 20 stations
Applicable connector	D-sub connector Compliant with MIL-C-24308 JIS-X-5101	Flat ribbon cable connector Socket: 26 pins MIL type with strain relief Compliant with MIL-C-83503	Flat ribbon cable connector Socket: 20 pins MIL type with strain relief Compliant with MIL-C-83503	Flat ribbon cable connector Socket: 10 pins MIL type with strain relief Compliant with MIL-C-83503	—	—	—
Internal wiring	SJ1000	Connector type: positive common, negative common					—
	SJ2000/3000	Connector type: non-polar, positive common, negative common/Cable type: positive common, negative common					—
4(A), 2(B) port piping specification	Location	Valve					
	Direction	Horizontal, Upward, Downward (Elbow fittings are used for upward or downward. Upward and downward are not available for the SJ1000.)					
Port size	1(P), 3/5(E) port	C6, C8, N7, N9 (Inch size elbow fittings are not available.)					
	4(A), 2(B) port	C2, C4					
	SJ1000	C2, C4, N1, N3, M3					
	SJ2000	C2, C4, C6, N1, N3, N7, M5					
Weight W [g]*2	n: Number of SUP/EXH blocks	Standard: $W = 51n + m + 133$					—
	m: Weight of DIN rail	Low-profile SUP/EXH block assembly specification: $W = 32n + m + 133^{*3}$					—

*1 The SJ1000 series does not support cable connection or individual wiring.

*2 The weight W is the value for the D-sub connector manifold with internal pilot and SUP/EXH block straight fittings specifications only. To obtain the weight with solenoid valves mounted, add the solenoid valve weights given on page 280 for the appropriate number of stations. Refer to page 346 for the weight of the DIN rail. (Please contact SMC for the weight of the external pilot specification with elbow fittings.)

*3 Refer to page 356 for low-profile SUP/EXH block assembly specifications.

* When many valves are operated simultaneously, use the B type (SUP/EXH both sides), supplying pressure to the 1(P) ports on both sides and exhausting from the 3/5(E) ports on both sides.

Flow Rate Characteristics

SJ1000 Series

Port size		Flow rate characteristics					
1(P) 3/5(E)	4, 2 (A, B)	1 → 4/2 (P → A/B)			4/2 → 3/5 (A/B → E)		
		C [dm ³ /(s·bar)]	b	Cv	C [dm ³ /(s·bar)]	b	Cv
C8	C2	0.12	0.64	0.04	0.13	0.59	0.04
	C4	0.28	0.35	0.08	0.32	0.33	0.08

SJ2000 Series

Port size		Flow rate characteristics					
1(P) 3/5(E)	4, 2 (A, B)	1 → 4/2 (P → A/B)			4/2 → 3/5 (A/B → E)		
		C [dm ³ /(s·bar)]	b	Cv	C [dm ³ /(s·bar)]	b	Cv
C8	C2	0.13	0.55	0.04	0.13	0.50	0.04
	C4	0.33	0.16	0.08	0.36	0.13	0.08
	M3	0.18	0.52	0.06	0.20	0.29	0.06

SJ3000 Series

Port size		Flow rate characteristics					
1(P) 3/5(E)	4, 2 (A, B)	1 → 4/2 (P → A/B)			4/2 → 3/5 (A/B → E)		
		C [dm ³ /(s·bar)]	b	Cv	C [dm ³ /(s·bar)]	b	Cv
C8	C2	0.13	0.56	0.04	0.14	0.51	0.04
	C4	0.42	0.17	0.11	0.45	0.16	0.11
	C6	0.55	0.10	0.12	0.56	0.11	0.12
	M5	0.40	0.28	0.11	0.45	0.15	0.11

* The values are for an individually operated 2-position type manifold base with 5 stations. Please contact SMC for details on 4-position dual 3-port valves.

Solenoid Valve Specifications

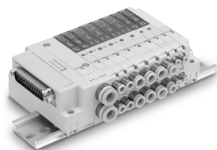

D-sub connector

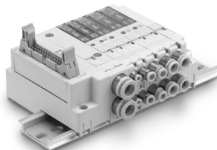

Flat ribbon cable

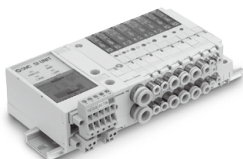

EX180 Integrated type (for output serial transmission system)

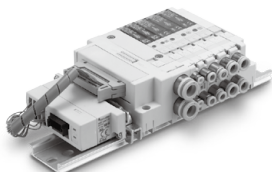

EX510 Gateway type serial transmission system

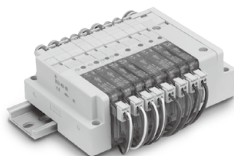

Individual wiring

Fluid		Air
Internal pilot operating pressure range [MPa]	2-position single	0.15 to 0.7
	4-position dual 3-port valve	
	2-position double	0.1 to 0.7
	3-position	0.2 to 0.7
External pilot operating pressure range [MPa]		Operating pressure range
External pilot operating pressure range [MPa]	2-position single	-100 kPa to 0.7
	2-position double	
	3-position	
Ambient and fluid temperatures [°C]		-10 to 50 (No freezing)
Max. operating frequency [Hz]	2-position single, double	10
	4-position dual 3-port valve	
	3-position	3
Manual override (Manual operation)		Non-locking push type Push-turn locking slotted type
Pilot exhaust method	Internal pilot	Main and pilot valve common exhaust
	External pilot	Pilot valve individual exhaust
Lubrication		Not required
Mounting orientation		Unrestricted
Impact/Vibration resistance [m/s ²]		150/30
Enclosure		Dustproof

* Impact resistance : No malfunction occurred when it is tested with a drop tester in the axial direction and at the right angles to the main valve and armature in both energized and de-energized states every once for each condition. (Value in the initial state)

Vibration resistance: No malfunction occurred in one sweep test between 45 and 2000 Hz in the axial direction and at the right angles to the main valve and armature in both energized and de-energized states for each condition. (Value in the initial state)

Solenoid Specifications

Coil rated voltage		24 VDC, 12 VDC	
Allowable voltage fluctuation		±10% of rated voltage*1	
Power consumption [W]	Standard	SJ2000	0.55
		SJ3000	0.4
	With power-saving circuit*3 (Continuous duty type)	SJ1000/2000	0.23*2 [Starting 0.55, Holding 0.23]
		SJ3000	0.15*2 [Starting 0.4, Holding 0.15]
Surge voltage suppressor		Diode	
Indicator light		LED	

*1 For the allowable voltage fluctuation for Z and T types (with power-saving circuit), please observe the following range because they have voltage drop due to internal circuit.

Z type 24 VDC: -7% to +10%

12 VDC: -4% to +10%

T type 24 VDC: -5% to +10%

12 VDC: -6% to +10%

*2 Refer to page 379 for details.

*3 SJ1000 series available as power-saving type only. Standard type (without power-saving circuit) cannot be selected.

Response Time

Type of actuation	Response time [ms] (at 0.5 MPa)		
	SJ1000	SJ2000	SJ3000
2-position single	16	16	16
2-position double	10	10	10
3-position	20	34	22
4-position dual 3-port valve	18	30	30

* Based on dynamic performance test. JIS B 8419:2010 (Coil temperature: 20°C, at rated voltage)

SJ1000/2000/3000 Series

Weight

Model: SJ1000/2000 Series

Valve model	Type of actuation		Port size 4(A), 2(B)	Weight [g]
SJ1□60T-C2	2-position	Single	C2 ($\varnothing 2$ One- touch fitting)	34
		Double		38
	3-position	Closed center		41
		Exhaust center		
		Pressure center		
	4-position	Dual 3-port valve		38
SJ1□60T-C4	2-position	Single	C4 ($\varnothing 4$ One- touch fitting)	36
		Double		40
	3-position	Closed center		43
		Exhaust center		
		Pressure center		
	4-position	Dual 3-port valve		40
SJ2□60-C2	2-position	Single	C2 ($\varnothing 2$ One- touch fitting)	43
		Double		46
	3-position	Closed center		50
		Exhaust center		
		Pressure center		
	4-position	Dual 3-port valve		46
SJ2□60-C4	2-position	Single	C4 ($\varnothing 4$ One- touch fitting)	41
		Double		44
	3-position	Closed center		48
		Exhaust center		
		Pressure center		
	4-position	Dual 3-port valve		44
SJ2□60-M3	2-position	Single	M3 x 0.5	39
		Double		42
	3-position	Closed center		46
		Exhaust center		
		Pressure center		
	4-position	Dual 3-port valve		42

* Please contact SMC for the weight of elbow fittings.

Model: SJ3000 Series

Valve model	Type of actuation		Port size 4(A), 2(B)	Weight [g]
SJ3□60-C2	2-position	Single	C2 ($\varnothing 2$ One- touch fitting)	63
		Double		71
	3-position	Closed center		75
		Exhaust center		
		Pressure center		
	4-position	Dual 3-port valve		71
SJ3□60-C4	2-position	Single	C4 ($\varnothing 4$ One- touch fitting)	65
		Double		73
	3-position	Closed center		77
		Exhaust center		
		Pressure center		
	4-position	Dual 3-port valve		73
SJ3□60-C6	2-position	Single	C6 ($\varnothing 6$ One- touch fitting)	61
		Double		69
	3-position	Closed center		73
		Exhaust center		
		Pressure center		
	4-position	Dual 3-port valve		69
SJ3□60-M5	2-position	Single	M5 x 0.8	57
		Double		65
	3-position	Closed center		69
		Exhaust center		
		Pressure center		
	4-position	Dual 3-port valve		65

* Please contact SMC for the weight of elbow fittings.

Connector Wiring Diagram

For both serial and parallel wiring, additional valves are sequentially assigned pins on the connector. This makes it completely unnecessary to disassemble the connector unit.

■ Single solenoid and double solenoid

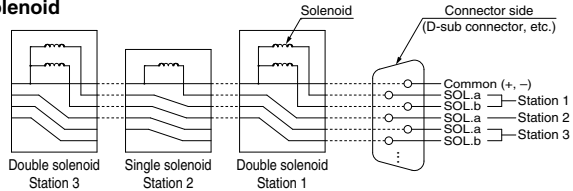

■ Single solenoid with double wiring

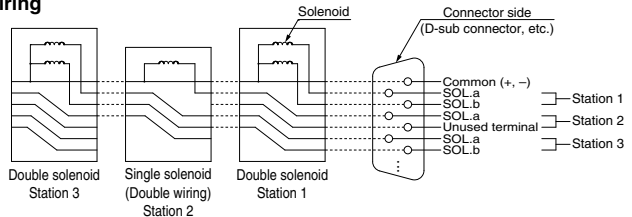

■ Mounting a valve with individual wiring

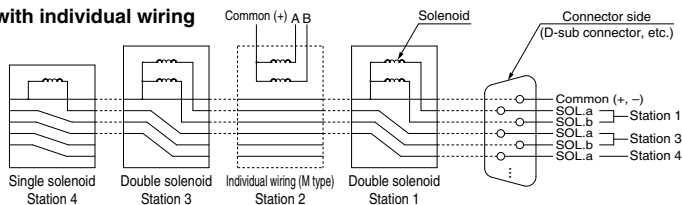

SJ1000/2000/3000 Series Construction

SJ1000/2000: Connector Type

Symbol

2-position single

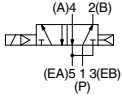

2-position single with back pressure check valve

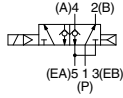

2-position double

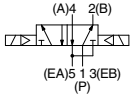

2-position double with back pressure check valve

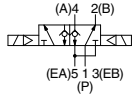

3-position closed center

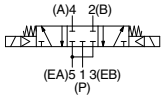

3-position exhaust center

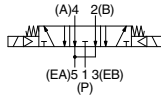

3-position pressure center

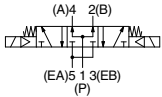

2-position single

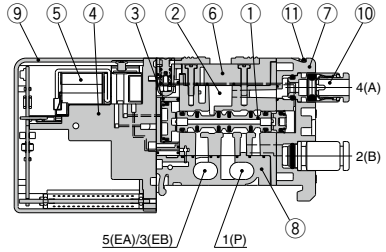

2-position double

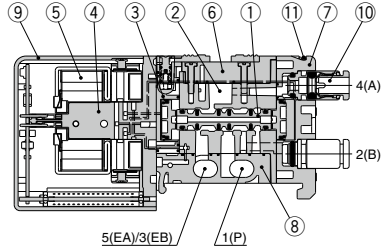

3-position closed center/exhaust center/pressure center

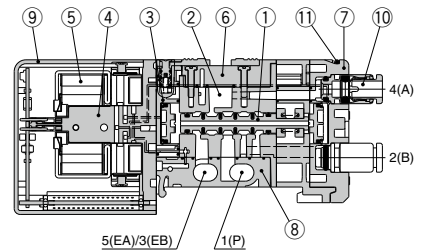

Component Parts

No.	Description	Material	Note
1	Spool valve assembly	Resin/HNBR (3-position solenoid valve: Aluminum/HNBR)	—
2	Body	Zinc die-cast	—
3	Adapter plate	Resin	White
4	Pilot adapter	Resin	White
5	Pilot valve assembly	—	—
6	Body cover	Resin	White
7	Port block	Resin	White
8	Bottom cover	Resin	White
9	Light cover	Resin	Light blue

Replacement Parts

No.	Description	Part no.	
10	One-touch fitting	Refer to the One-touch fitting part no. on page 381.	
11	Clip	SJ1000 SJ2000	SJ1000-CL-1 (10 pcs.) SJ2000-CL-1 (10 pcs.)

SJ1260KT/SJ2260K

[With back pressure check valve]

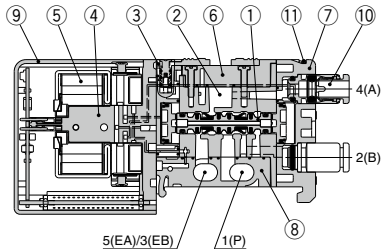

SJ1000/2000/3000 Series

SJ1000/2000: Connector Type

Symbol

4-position dual 3-port valve
SJ1A60T/SJ2A60
[N.C. valve x 2]

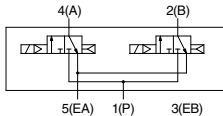

SJ1A60KT/SJ2A60K
with back pressure check valve

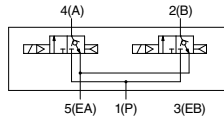

SJ1B60T/SJ2B60
[N.O. valve x 2]

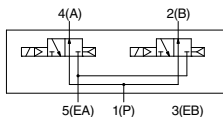

SJ1B60KT/SJ2B60K
with back pressure check valve

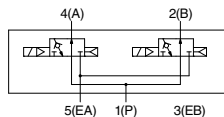

SJ1C60T/SJ2C60
[N.C., N.O. valve x 1 (each)]

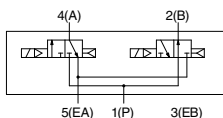

SJ1C60KT/SJ2C60K
with back pressure check valve

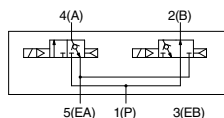

SJ1A60T/SJ2A60 [N.C. valve x 2]

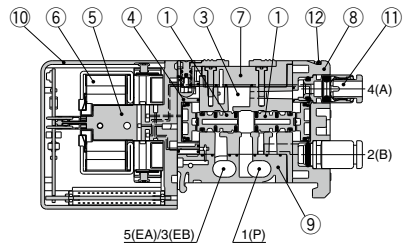

SJ1B60T/SJ2B60 [N.O. valve x 2]

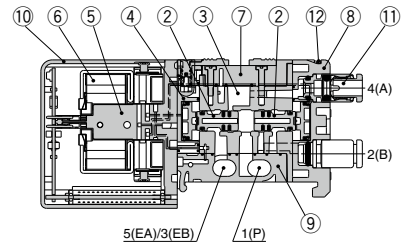

SJ1C60T/SJ2C60 [N.C., N.O. valve x 1 (each)]

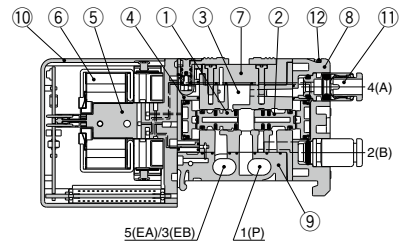

Component Parts

No.	Description	Material	Note
1	Spool valve assembly	Resin/HNBR	N.C. (Normally closed)
2	Spool valve assembly	Resin/HNBR	N.O. (Normally open)
3	Body	Zinc die-cast	—
4	Adapter plate	Resin	White
5	Pilot adapter	Resin	White
6	Pilot valve assembly	—	—
7	Body cover	Resin	White
8	Port block	Resin	White
9	Bottom cover	Resin	White
10	Light cover	Resin	Light blue

Replacement Parts

No.	Description	Part no.
11	One-touch fitting	Refer to the One-touch fitting part no. on page 381.
12	Clip	SJ1000 SJ1000-CL-1 (10 pcs.)
		SJ2000 SJ2000-CL-1 (10 pcs.)

SJ1A60KT/SJ2A60K

[With back pressure check valve]

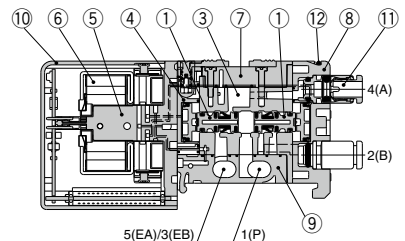

SJ3000: Connector Type

Symbol

2-position single

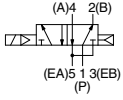

2-position single with back pressure check valve

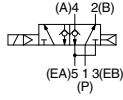

2-position double

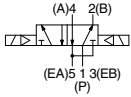

2-position double with back pressure check valve

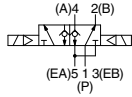

3-position closed center

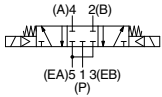

3-position exhaust center

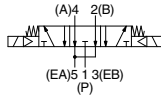

3-position pressure center

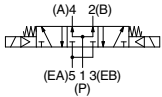

2-position single

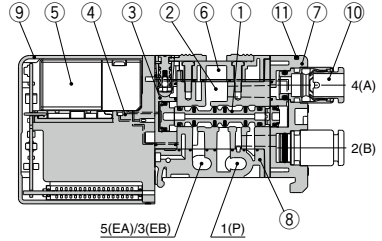

2-position double

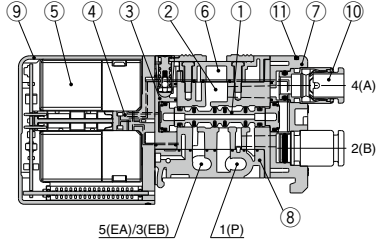

3-position closed center/exhaust center/pressure center

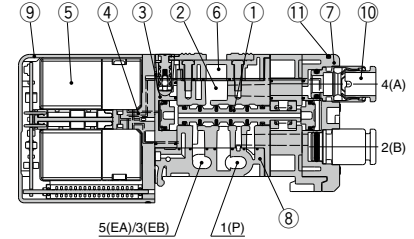

Component Parts

No.	Description	Material	Note
1	Spool valve assembly	Resin/HNBR (3-position solenoid valve: Aluminum/HNBR)	—
2	Body	Zinc die-cast	—
3	Adapter plate	Resin	White
4	Pilot adapter	Resin	White
5	Pilot valve assembly	—	—
6	Body cover	Resin	White
7	Port block	Resin	White
8	Bottom cover	Resin	White
9	Light cover	Resin	Light blue

Replacement Parts

No.	Description	Part no.
10	One-touch fitting	Refer to the One-touch fitting part no. on page 381.
11	Clip	SJ3000-CL-1 (10 pcs.)

SJ3260K [With back pressure check valve]

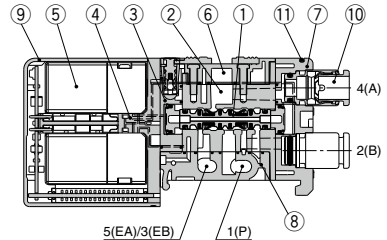

SJ1000/2000/3000 Series

SJ3000: Connector Type

Symbol

4-position dual 3-port valve
SJ3A60 [N.C. valve x 2]

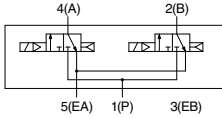

SJ3A60K with back pressure check valve

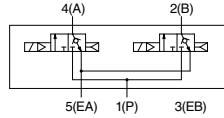

SJ3B60 [N.O. valve x 2]

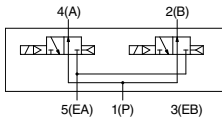

SJ3B60K with back pressure check valve

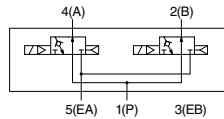

SJ3C60 [N.C., N.O. valve x 1 (each)]

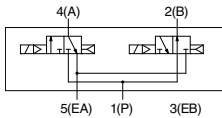

SJ3C60K with back pressure check valve

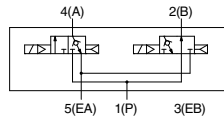

SJ3A60 [N.C. valve x 2]

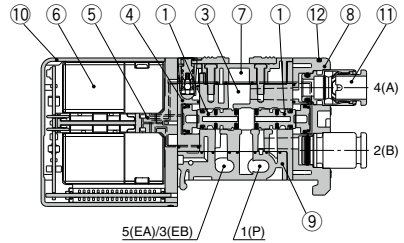

SJ3B60 [N.O. valve x 2]

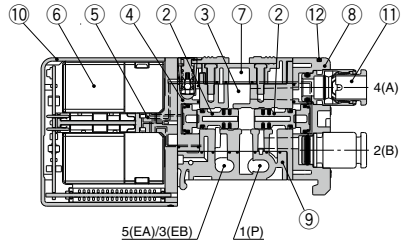

SJ3C60 [N.C. valve, N.O. valve x 1 (each)]

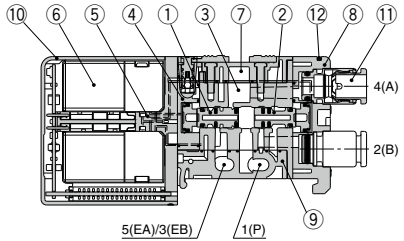

Component Parts

No.	Description	Material	Note
1	Spool valve assembly	Resin/HNBR	N.C. (Normally closed)
2	Spool valve assembly	Resin/HNBR	N.O. (Normally open)
3	Body	Zinc die-cast	—
4	Adapter plate	Resin	White
5	Pilot adapter	Resin	White
6	Pilot valve assembly	—	—
7	Body cover	Resin	White
8	Port block	Resin	White
9	Bottom cover	Resin	White
10	Light cover	Resin	Light blue

Replacement Parts

No.	Description	Part no.
11	One-touch fitting	Refer to the One-touch fitting part no. on page 381.
12	Clip	SJ3000-CL-1 (10 pcs.)

SJ3A60K [With back pressure check valve]

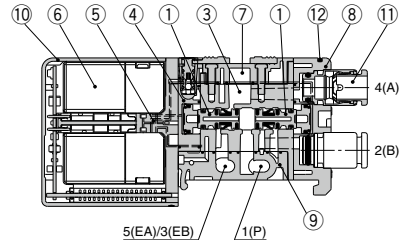

SJ2000: Cable Type

Symbol

2-position single

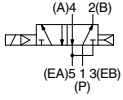

2-position single with back pressure check valve

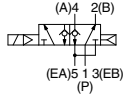

2-position double

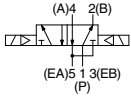

2-position double with back pressure check valve

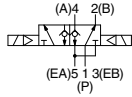

3-position closed center

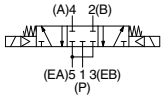

3-position exhaust center

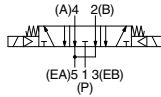

3-position pressure center

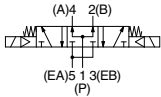

2-position single

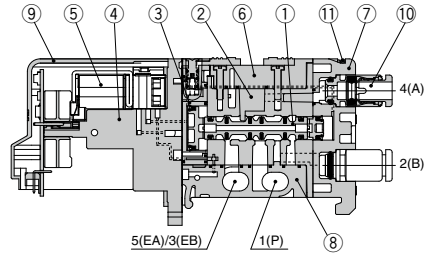

2-position double

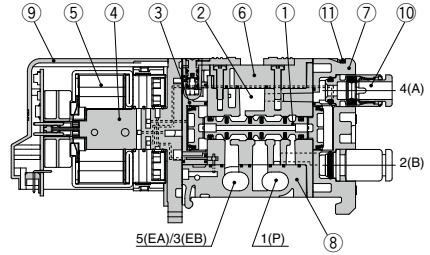

3-position closed center/exhaust center/pressure center

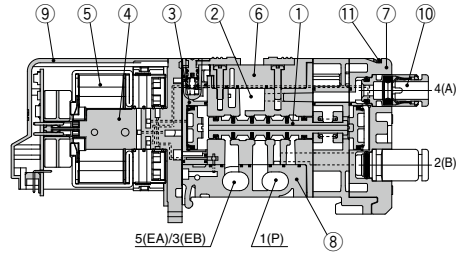

Component Parts

No.	Description	Material	Note
1	Spool valve assembly	Resin/HNBR (3-position solenoid valve: Aluminum/HNBR)	—
2	Body	Zinc die-cast	—
3	Adapter plate	Resin	White
4	Pilot adapter	Resin	White
5	Pilot valve assembly	—	—
6	Body cover	Resin	White
7	Port block	Resin	White
8	Bottom cover assembly	Resin	White
9	Light cover	Resin	Light blue

Replacement Parts

No.	Description	Part no.
10	One-touch fitting	Refer to the One-touch fitting part no. on page 381.
11	Clip	SJ2000-CL-1 (10 pcs.)

SJ2260K [With back pressure check valve]

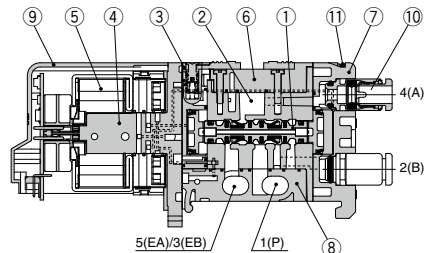

SJ1000/2000/3000 Series

SJ2000: Cable Type

Symbol

4-position dual 3-port valve
SJ2A60 [N.C. valve x 2]

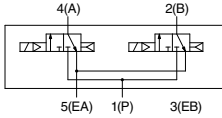

SJ2A60K with back pressure check valve

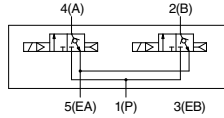

SJ2B60 [N.O. valve x 2]

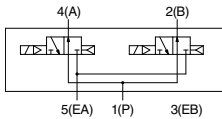

SJ2B60K with back pressure check valve

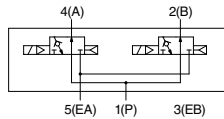

SJ2C60 [N.C., N.O. valve x 1 (each)]

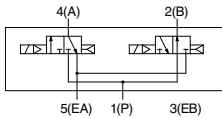

SJ2C60K with back pressure check valve

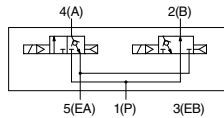

SJ2A60 [N.C. valve x 2]

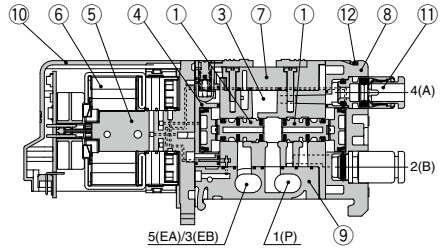

SJ2B60 [N.O. valve x 2]

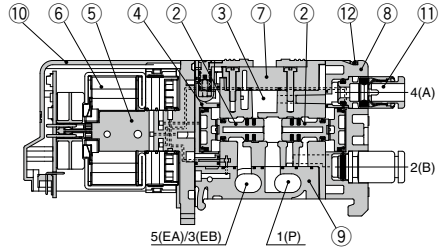

SJ2C60 [N.C. valve, N.O. valve x 1 (each)]

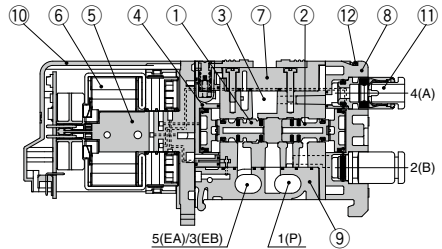

Component Parts

No.	Description	Material	Note
1	Spool valve assembly	Resin/HNBR	N.C. (Normally closed)
2	Spool valve assembly	Resin/HNBR	N.O. (Normally open)
3	Body	Zinc die-cast	—
4	Adapter plate	Resin	White
5	Pilot adapter	Resin	White
6	Pilot valve assembly	—	—
7	Body cover	Resin	White
8	Port block	Resin	White
9	Bottom cover assembly	Resin	White
10	Light cover	Resin	Light blue

Replacement Parts

No.	Description	Part no.
11	One-touch fitting	Refer to the One-touch fitting part no. on page 381.
12	Clip	SJ2000-CL-1 (10 pcs.)

SJ2A60K [With back pressure check valve]

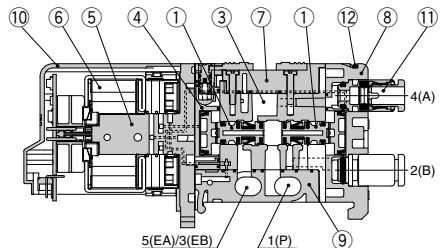

SJ3000: Cable Type

Symbol

2-position single

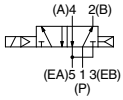

2-position single with back pressure check valve

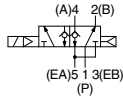

2-position double

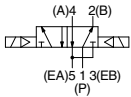

2-position double with back pressure check valve

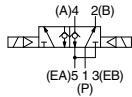

3-position closed center

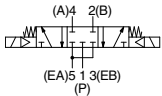

3-position exhaust center

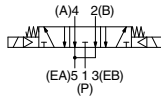

3-position pressure center

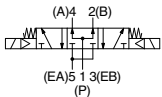

Component Parts

No.	Description	Material	Note
1	Spool valve assembly	Resin/HNBR (3-position solenoid valve: Aluminum/HNBR)	—
2	Body	Zinc die-cast	—
3	Adapter plate	Resin	White
4	Pilot adapter	Resin	White
5	Pilot valve assembly	—	—
6	Body cover	Resin	White
7	Port block	Resin	White
8	Bottom cover assembly	Resin	White
9	Light cover	Resin	Light blue

Replacement Parts

No.	Description	Part no.
10	One-touch fitting	Refer to the One-touch fitting part no. on page 381.
11	Clip	SJ3000-CL-1 (10 pcs.)

2-position single

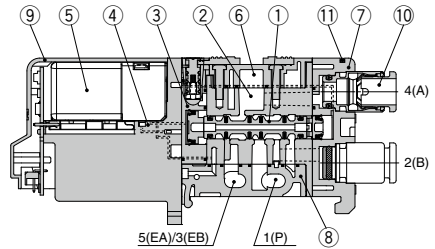

2-position double

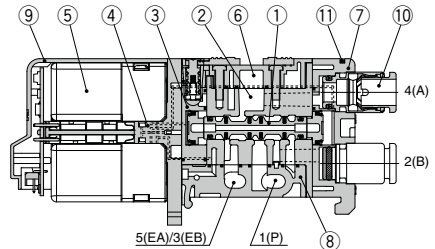

3-position closed center/exhaust center/pressure center

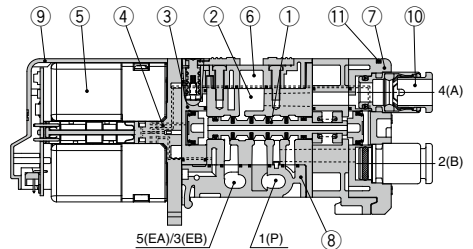

SJ3260K [With back pressure check valve]

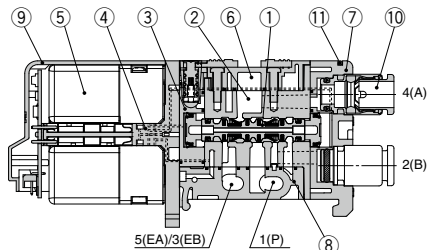

SJ1000/2000/3000 Series

SJ3000: Cable Type

Symbol

4-position dual 3-port valve
SJ3A60 [N.C. valve x 2]

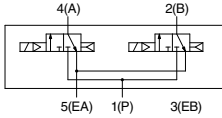

SJ3A60K with back pressure check valve

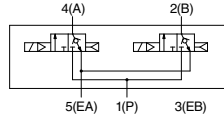

SJ3B60 [N.O. valve x 2]

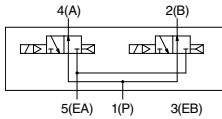

SJ3B60K with back pressure check valve

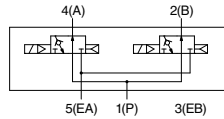

SJ3C60 [N.C., N.O. valve x 1 (each)]

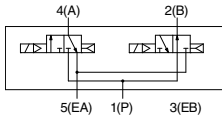

SJ3C60K with back pressure check valve

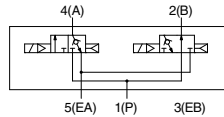

SJ3A60 [N.C. valve x 2]

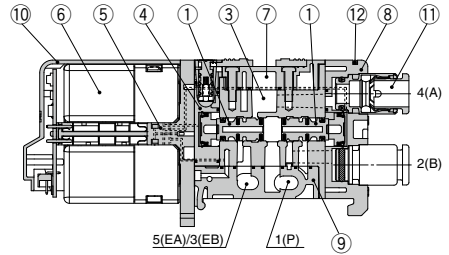

SJ3B60 [N.O. valve x 2]

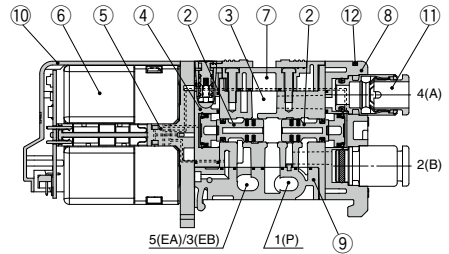

SJ3C60 [N.C. valve, N.O. valve x 1 (each)]

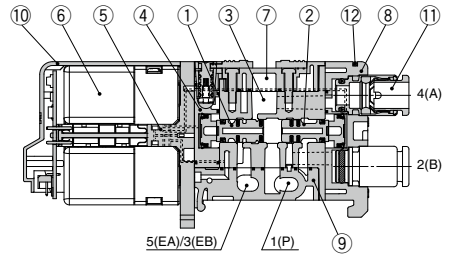

SJ3A60K [With back pressure check valve]

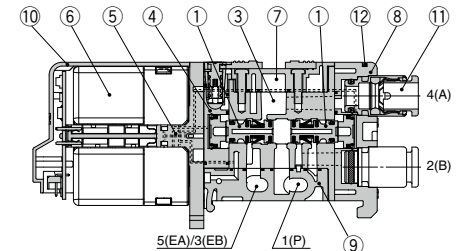

Component Parts

No.	Description	Material	Note
1	Spool valve assembly	Resin/HNBR	N.C. (Normally closed)
2	Spool valve assembly	Resin/HNBR	N.O. (Normally open)
3	Body	Zinc die-cast	—
4	Adapter plate	Resin	White
5	Pilot adapter	Resin	White
6	Pilot valve assembly	—	—
7	Body cover	Resin	White
8	Port block	Resin	White
9	Bottom cover assembly	Resin	White
10	Light cover	Resin	Light blue

Replacement Parts

No.	Description	Part no.
11	One-touch fitting	Refer to the One-touch fitting part no. on page 381.
12	Clip	SJ3000-CL-1 (10 pcs.)

**Plug-in
Connector Type Manifold
Cable Type Manifold**

SJ1000/2000/3000 Series

p. 290

**Connector Type Manifold
D-sub Connector/Flat Ribbon Cable**

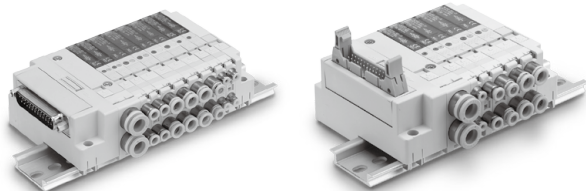

p. 292

**Cable Type Manifold
D-sub Connector/Flat Ribbon Cable**

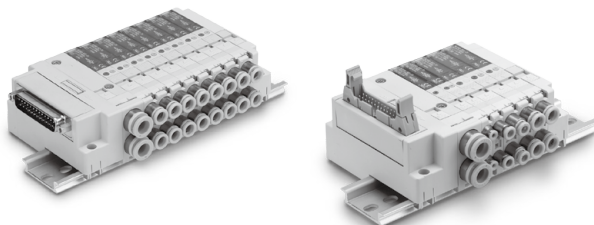

p. 312

**Connector Type Manifold
EX180 Integrated Type (For
Output) Serial Transmission
System**

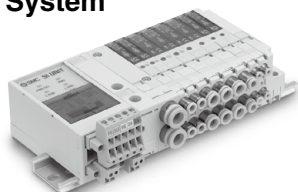

p. 322

**Connector Type Manifold
EX510 Gateway Type
Serial Transmission System**

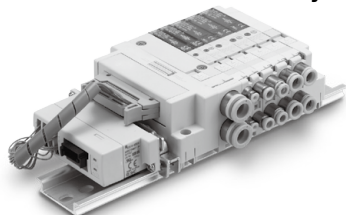

Plug-in Connector Type



D-sub Connector/Flat Ribbon Cable

RoHS

SJ1000/2000/3000 Series

An order cannot be placed with only the manifold part no. Be sure to order solenoid valves for mounting at the same time while referring to the ordering example.

How to Order

● Connector type manifold

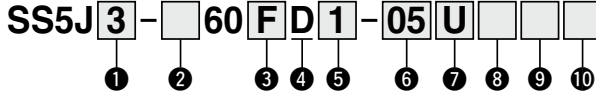

1 Series

1	SJ1000
2	SJ2000
3	SJ3000 (SJ1000/2000/3000 mixed*)

*1 Select "3" for the combination of SJ1000 and SJ2000 valves.

2 Mixed mounting type

Nil	Standard*1
M	Mixed mounting*2

*1 For SJ1000, 2000, and 3000 series valves, select "Nil" when only using a single series.
*2 Select "M" when SJ1000, SJ2000, or SJ3000 series valves will be mounted on the same manifold base together.

3 Connector type

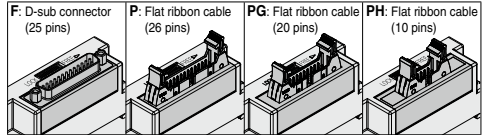

4 Connector mounting position

Symbol	Mounting position
D	D side

5 Connector entry direction

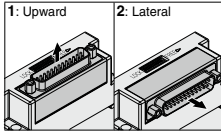

6 Valve stations

F: D-sub connector

Symbol	Stations	Note
01	1 station	Up to 24 solenoids can be selected.
⋮	⋮	
24	24 stations	

Symbol	Stations	Note
01	1 station	Up to 18 solenoids can be selected.
⋮	⋮	
18	18 stations	

P: Flat ribbon cable (26 pins)

Symbol	Stations	Note
01	1 station	Up to 24 solenoids can be selected.
⋮	⋮	
24	24 stations	

PG: Flat ribbon cable (20 pins)

Symbol	Stations	Note
01	1 station	Up to 8 solenoids can be selected.
⋮	⋮	
08	8 stations	

7 SUP/EXH block mounting position

U	U side
D	D side
B	Both sides
M*	Special specifications

*1 Specify the required specifications (including port sizes other than Ø8) on the manifold specification sheet.

* This number also includes the blanking block assembly. Since single and double wiring are available for the blanking block assembly, select a model compatible with the valve wiring specification to be used. (Refer to page 345.)

8 Pilot type

Nil	Internal pilot
S	Internal pilot, Built-in silencer
R	External pilot
RS	External pilot, Built-in silencer

* There is no need to enter anything when the SUP/EXH block mounting position "M" is selected.
* The 3/5(E) port is plugged for the built-in silencer type.

9 SUP/EXH block fitting specification

Nil	L	B
Straight fitting With external pilot spec. X, PE port: Elbow fitting	Elbow fitting (Upward) With external pilot spec. X, PE port: Straight fitting	Elbow fitting (Downward) With external pilot spec. X, PE port: Elbow fitting

* There is no need to enter anything when the SUP/EXH block mounting position "M" is selected.

10 DIN rail length specified

Nil	Standard length
2	2 stations
⋮	⋮
24	24 stations

* Specify the number of valve stations without exceeding the max. number of stations.

How to Order Manifold Assembly

Ordering example (SS5J3-60PD2-□)

Double solenoid, individual wiring/
lead wire length 300 mm (24 VDC)
SJ3260-5MZ-C6 (1 set)

Double solenoid, with switch (24 VDC)
SJ3260-5CZJ-C6 (1 set)

Double solenoid (24 VDC)
SJ3260-5CU-C6 (2 sets)

Single solenoid (24 VDC)
SJ3160-5CU-C6 (2 sets)

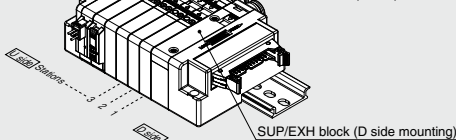

- SS5J3-60PD2-06D 1 set (Manifold part no.)
- * SJ3160-5CU-C6 2 sets (Single solenoid part no.)
- * SJ3260-5CU-C6 2 sets (Double solenoid part no.)
- * SJ3260-5CZJ-C6 1 set (Double solenoid, with switch part no.)
- * SJ3260-5MZ-C6 1 set (Double solenoid, individual wiring/
lead wire length 300 mm part no.)

The asterisk denotes the symbol for the assembly.
Prefix it to the part numbers of the solenoid valve, etc.

- * For the valve arrangement, the valve closest to the D side is considered the 1st station.
- * Under the manifold part number, state the valves to be mounted in order starting with the 1st station as shown in the figure. If the arrangement becomes too complicated, specify the details on a manifold specification sheet.
- * When ordering a manifold, specify the part nos. of the valves to be mounted on it. (An order cannot be placed with only the manifold part no.)

How to Order Solenoid Valves

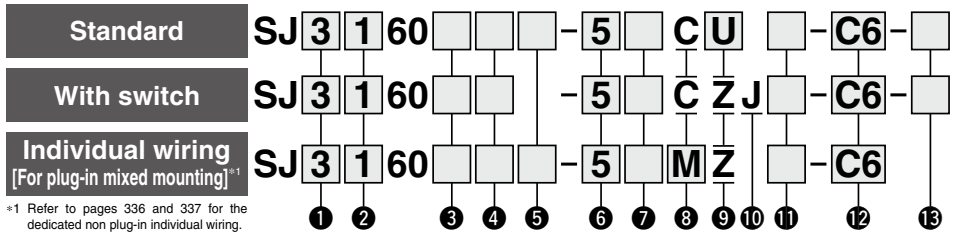

*1 Refer to pages 336 and 337 for the dedicated non plug-in individual wiring.

1 Series

1	SJ1000
2	SJ2000
3	SJ3000

2 Type of actuation

1	2-position single solenoid
2	2-position double solenoid
3	3-position closed center
4	3-position exhaust center
5	3-position pressure center
A	Dual 3-port valve: N.C./N.C.
B	Dual 3-port valve: N.O./N.O.
C	Dual 3-port valve: N.C./N.O.

* Refer to pages 281 to 284 for the symbol.

3 Pilot type

Nil	Internal pilot
R	External pilot

* External pilot specification is not applicable for 4-position dual 3-port valves.

4 Back pressure check valve

Nil	None
K	Built-in

* Back pressure check valve is not applicable for 3-position valve.

5 Coil type

Symbol	Coil type	SJ1000	SJ2000	SJ3000
Nil	Standard	—	●	●
T	With power-saving circuit (Continuous duty type)	●	●	●

* Be sure to select the power-saving circuit type if the valve is to be continuously energized for long periods of time.
 * For the SJ1000 series, only the power-saving circuit type is available.

6 Rated voltage

5	24 VDC
6	12 VDC

7 Common specification

Nil	Positive common
N	Negative common

* For the non-polar type, there is no need to select a symbol.

8 Connector entry

Symbol	C: Dedicated for centralized wiring	M: Individual wiring. With lead wire Length 300 mm	MN: Individual wiring. Without lead wire (With connector, socket)	MO: Individual wiring. Without connector
SJ1000	●	—	—	—
SJ2000	●	●	●	●
SJ3000	●	●	●	●

* Connector entries with the symbol "MCT" cannot use the switch signal from the common wiring on the manifold. For details, refer to the "Connector Wiring Diagram" on page 280.
 * When ordering a connector assembly separately, refer to pages 383 and 384.

9 Light/surge voltage suppressor

Symbol	Specification	SJ1000	SJ2000	SJ3000
U	With light/surge voltage suppressor (Non-polar type)	—	●	●
Z	With light/surge voltage suppressor (Polar type)	●	●	●

* When the types with power-saving circuit, with switches, and individual wiring are used, the non-polar type cannot be selected.

10 With switch

	SJ1000	SJ2000	SJ3000
	—	●	●

11 Manual override

Symbol/Specification	SJ1000	SJ2000	SJ3000
Nil: Non-locking push type	●	●	●
D: Push-turn locking slotted type	●	●	●
F: Slide locking type	—	●	●

12 A, B port size

Metric/One-touch fitting

Symbol	A, B port	SJ1000	SJ2000	SJ3000
C2	Straight	●	●	●
C4		●	●	●
C6		●	●	●
L2	Elbow	—	●	●
L4		—	●	●
L6		—	●	●
B2		—	●	●
B4	Downward entry	—	●	●
B6		—	●	●

Thread piping

Symbol	A, B port	SJ1000	SJ2000	SJ3000
M3	M3 x 0.5	—	●	—
M5	M5 x 0.8	—	—	●

Inch/One-touch fitting

Symbol	A, B port	SJ1000	SJ2000	SJ3000
N1	Straight	—	●	●
N3		—	●	●
N7		—	—	●
LN1	Upward entry	—	●	●
LN3		—	●	●
LN7		—	—	●
BN1	Downward entry	—	●	●
BN3		—	●	●
BN7		—	—	●

13 Single solenoid wiring specification

Nil	Single wiring
D	Double wiring

* There is no need to enter anything for 2-position double, 3-position, and 4-position solenoid valves. Select this when the unused numbers to wiring are set. Refer to page 280 for details.

Protective class class III (Mark:)

Plug-in Cable Type



D-sub Connector/Flat Ribbon Cable



SJ2000/3000 Series

An order cannot be placed with only the manifold part no. Be sure to order solenoid valves for mounting at the same time while referring to the ordering example.

How to Order

● Cable type manifold

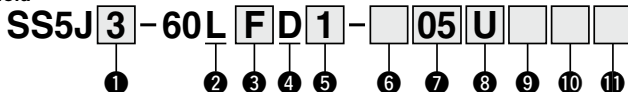

1 Series

2	SJ2000
3	SJ3000

2 Cable type

4 Connector mounting position

Symbol	Mounting position
D	D side

6 Manifold wiring specification

NII	All double wiring*1
S	All single wiring*2

*1 All double wiring: 2-position single, 2-position double, 3-position, and 4-position valves can be used on all manifold stations.

*2 All single wiring: Available only for manifolds which have 2-position single valves on all stations.

Note that 2-position double, 3-position, or 4-position valves cannot be used.

* If a mixture of single wiring and double wiring is required, it is available as a special order.

3 Connector type

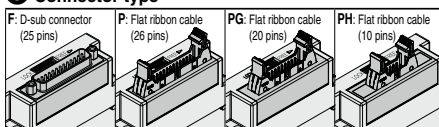

5 Connector entry direction

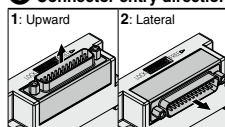

7 Valve stations

F: D-sub connector (25 pins)			P: Flat ribbon cable (26 pins)		
Symbol	Stations	Note	Symbol	Stations	Note
02	2 stations	All double wiring	02	2 stations	All double wiring
10	10 stations		10	10 stations	
02	2 stations	All single wiring	02	2 stations	All single wiring
20	20 stations		20	20 stations	
PG: Flat ribbon cable (20 pins)			PH: Flat ribbon cable (10 pins)		
Symbol	Stations	Note	Symbol	Stations	Note
02	2 stations	All double wiring	02	2 stations	All double wiring
09	9 stations		04	4 stations	
02	2 stations	All single wiring	02	2 stations	All single wiring
18	18 stations		08	8 stations	

8 SUP/EXH block mounting position

U	U side
D	D side
B	Both sides
M*1	Special specifications

*1 Specify the required specifications (including port sizes other than ø8) on the manifold specification sheet.

* Due to the length of the cable assembly, the max. number of supply and exhaust blocks that can be installed is 3 in total: one set between stations, one set on the D-side, and one set on the U-side end of the manifold.

9 Pilot type

NII	Internal pilot
S	Internal pilot, Built-in silencer
R	External pilot
RS	External pilot, Built-in silencer

* There is no need to enter anything when the SUP/EXH block mounting position "M" is selected.

10 SUP/EXH block fitting specification

NII	L	B
Straight fitting	Elbow fitting (Upward)	Elbow fitting (Downward)
With external pilot spec. X, PE port: Elbow fitting	With external pilot spec. X, PE port: Straight fitting	With external pilot spec. X, PE port: Elbow fitting

* There is no need to enter anything when the SUP/EXH block mounting position "M" is selected.

11 DIN rail length specified

NII	Standard length
3	3 stations
2	Specify a length longer than that of the standard rail.
20	20 stations

* Specify the number of valve stations without exceeding the max. number of stations.

How to Order Manifold Assembly

Ordering example (SS5J3-60LPD2)

Double solenoid (24 VDC)
SJ3260-5FZ-C6 (4 sets)

Single solenoid (24 VDC)
SJ3160-5FZ-C6 (2 sets)

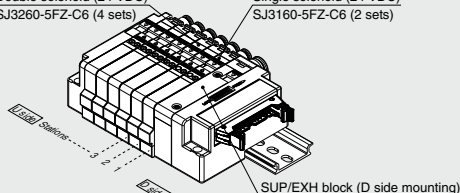

SS5J3-60LPD2-06D.....1 set (Manifold part no.)
 * SJ3160-5FZ-C62 sets (Single solenoid part no.)
 * SJ3260-5FZ-C64 sets (Double solenoid part no.)
 The asterisk denotes the symbol for the assembly.
 Prefix it to the part numbers of the solenoid valve, etc.

• For the valve arrangement, the valve closest to the D side is considered the 1st station.

• Under the manifold part number, state the valves to be mounted in order starting with the 1st station as shown in the figure. If the arrangement becomes too complicated, specify the details on a manifold specification sheet.

* When ordering a manifold, specify the part nos. of the valves to be mounted on it. (An order cannot be placed with only the manifold part no.)

How to Order Solenoid Valves

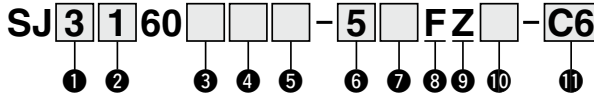

① Series

2	SJ2000
3	SJ3000

② Type of actuation

1	2-position single solenoid
2	2-position double solenoid
3	3-position closed center
4	3-position exhaust center
5	3-position pressure center
A	Dual 3-port valve: N.C./N.C.
B	Dual 3-port valve: N.O./N.O.
C	Dual 3-port valve: N.C./N.O.

* Refer to pages 285 to 288 for the symbol.

③ Pilot type

Nil	Internal pilot
R	External pilot

* External pilot specification is not applicable for 4-position dual 3-port valves.

④ Back pressure check valve

Nil	None
K	Built-in

* Back pressure check valve is not applicable for 3-position valve.

⑤ Coil type

Nil	Standard
T	With power-saving circuit (Continuous duty type)

* Be sure to select the power-saving circuit type if the valve is to be continuously energized for long periods of time.

⑥ Rated voltage

5	24 VDC
6	12 VDC

⑧ Connector entry

F: Dedicated for centralized wiring, cable type

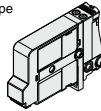

⑦ Common specification

Nil	Positive common
N	Negative common

⑨ Light/surge voltage suppressor

Z	With light/surge voltage suppressor
---	-------------------------------------

⑩ Manual override

<p>Nil: Non-locking push type</p>	<p>D: Push-turn locking slotted type</p>	<p>F: Slide locking type</p>
--	---	---

⑪ A, B port size

<p>Straight (Metric size) C2: ø2 One-touch fitting C4: ø4 One-touch fitting C6: ø6 One-touch fitting (SJ3000 only)</p> <p>(Inch size) N1: ø1/8" One-touch fitting N3: ø5/32" One-touch fitting N7: ø1/4" One-touch fitting (SJ3000 only)</p>	<p>M3: M3 x 0.5 (SJ2000 only) M5: M5 x 0.8 (SJ3000 only)</p>	<p>Elbow fitting (Upward entry) (Metric size) L2: ø2 elbow fitting L4: ø4 elbow fitting L6: ø6 elbow fitting (SJ3000 only)</p> <p>(Inch size) LN1: ø1/8" elbow fitting LN3: ø5/32" elbow fitting LN7: ø1/4" elbow fitting (SJ3000 only)</p>	<p>Elbow fitting (Downward entry) (Metric size) B2: ø2 elbow fitting B4: ø4 elbow fitting B6: ø6 elbow fitting (SJ3000 only)</p> <p>(Inch size) BN1: ø1/8" elbow fitting BN3: ø5/32" elbow fitting BN7: ø1/4" elbow fitting (SJ3000 only)</p>
---	--	--	--

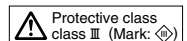

SJ1000/2000/3000 Series

Manifold Electrical Wiring: Connector Type (Non-polar Type)

Type 60F: D-sub connector (25 pins)

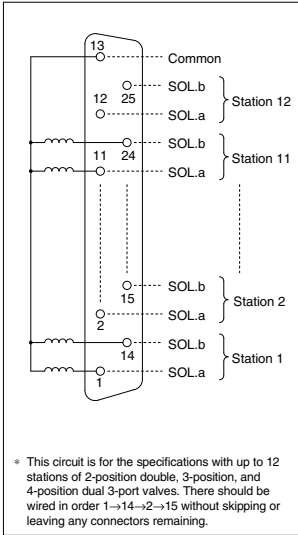

Type 60P: Flat ribbon cable (26 pins)

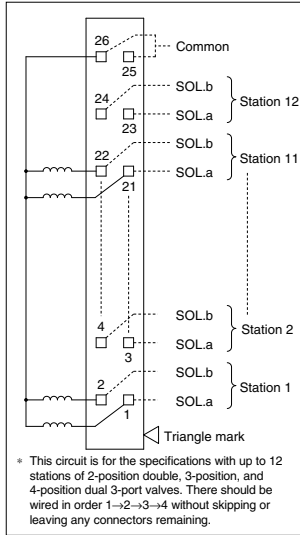

Type 60PG: Flat ribbon cable (20 pins)

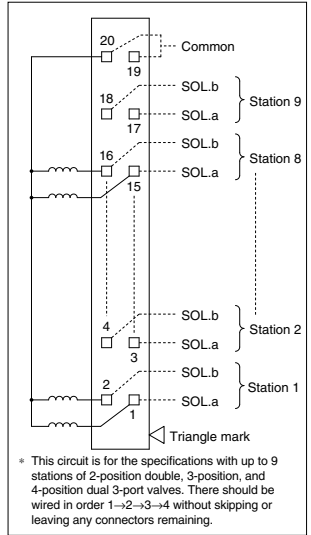

Type 60PH: Flat ribbon cable (10 pins)

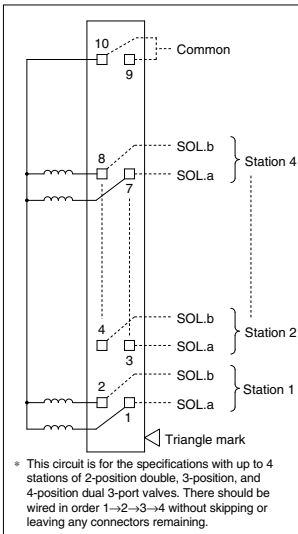

⚠ Caution

When the non-polar U type valves are used, either positive common or negative common wiring of the manifold is possible. However, when the Z type valves are used, select the positive common or negative common according to the wiring specifications.

Manifold Electrical Wiring: Cable Type

Type 60LF: D-sub connector (25 pins)

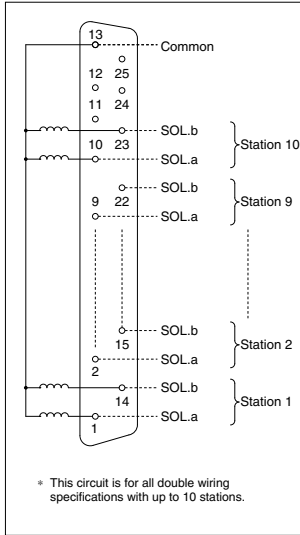

Type 60LP: Flat ribbon cable (26 pins)

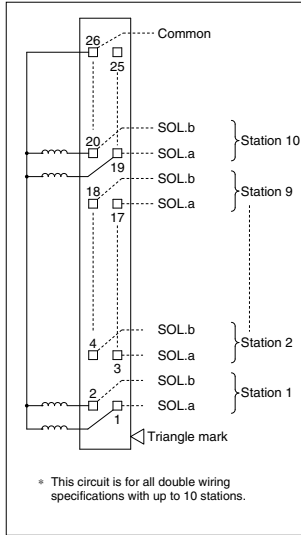

Type 60LPG: Flat ribbon cable (20 pins)

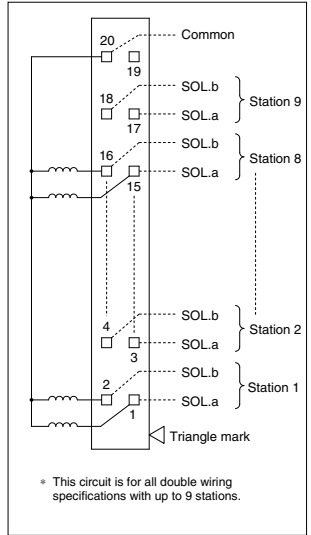

Type 60LPH: Flat ribbon cable (10 pins)

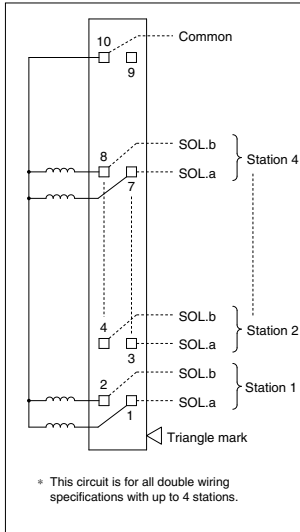

⚠ Caution

For electrical connections, select the positive common or negative common according to the wiring specifications.

SJ1000/2000/3000 Series

Dimensions: SJ1000 Series for D-sub Connector

SS5J1-60FD₂-[Stations]U(S, R, RS)

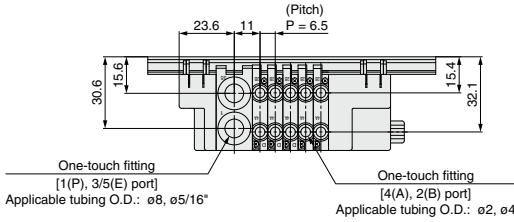

[External pilot specification]

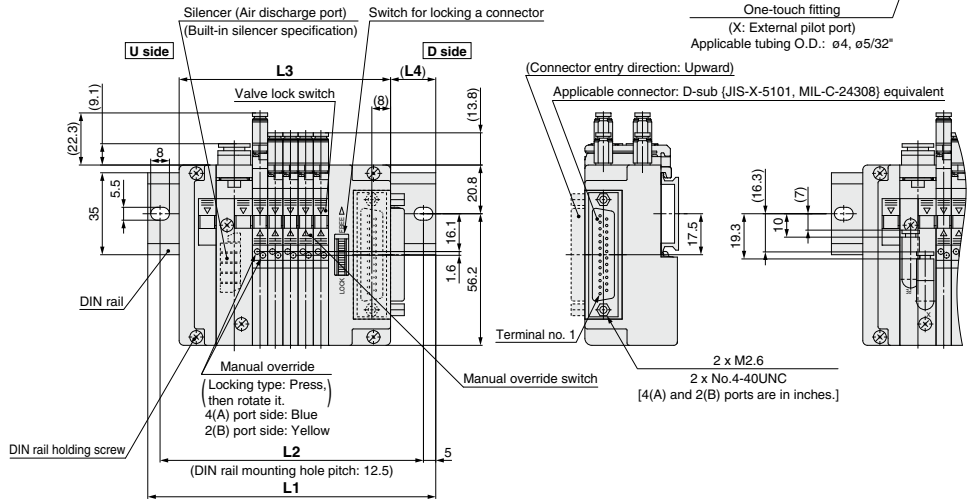
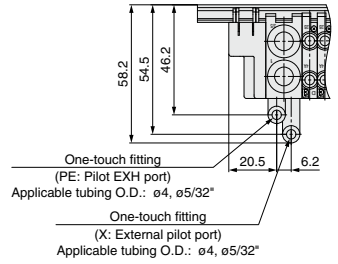

(Station n)----- (Station 1)

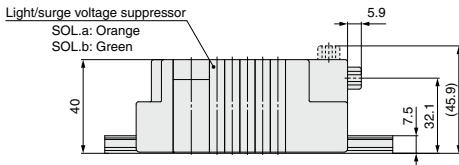

L: Dimensions

n: Stations

L/n	1	2	3	4	5	6	7	8	9	10	11	12	13	14	15	16	17	18	19	20	21	22	23	24
L1	98	110.5	110.5	123	123	135.5	135.5	148	148	160.5	160.5	173	173	185.5	185.5	198	198	210.5	210.5	223	235.5	235.5	248	248
L2	87.5	100	100	112.5	112.5	125	125	137.5	137.5	150	150	162.5	162.5	175	175	187.5	187.5	200	200	212.5	225	225	237.5	237.5
L3	64.3	70.8	77.3	83.8	90.3	96.8	103.3	109.8	116.3	122.8	129.3	135.8	142.3	148.8	155.3	161.8	168.3	174.8	181.3	187.8	194.3	200.8	207.3	213.8
L4	20	23	19.5	22.5	19.5	22.5	19	22	19	22	18.5	21.5	18.5	21.5	18	21	18	21	17.5	20.5	23.5	20.5	23.5	20

Dimensions: SJ1000 Series for D-sub Connector

SS5J1-60FD₂-[Stations]B(S, R, RS)

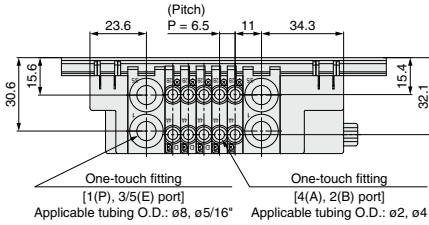

[External pilot specification]
 (There are piping of X and PE ports on both sides.)

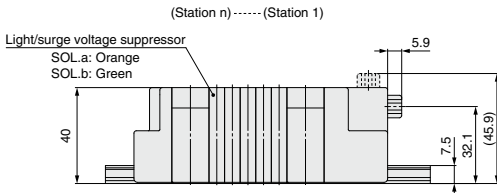
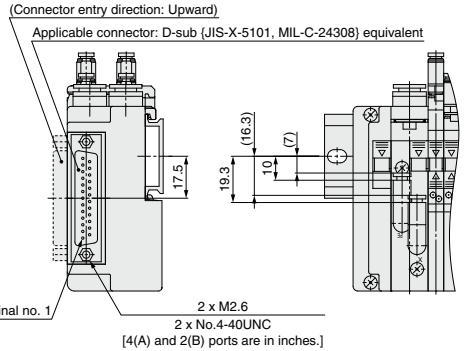
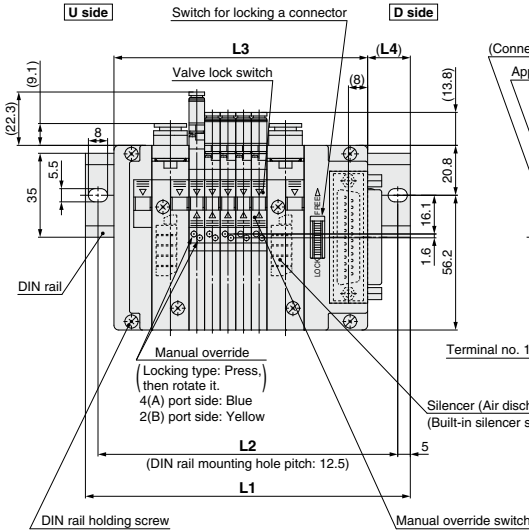
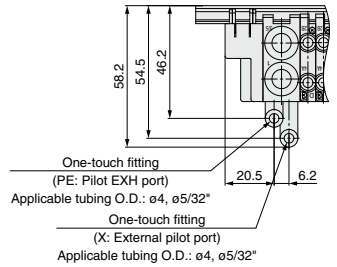

L: Dimensions

n: Stations

L \ n	1	2	3	4	5	6	7	8	9	10	11	12	13	14	15	16	17	18	19	20	21	22	23	24
L1	110.5	123	123	135.5	135.5	148	148	160.5	173	173	185.5	185.5	198	198	210.5	210.5	223	223	235.5	235.5	248	248	260.5	260.5
L2	100	112.5	112.5	125	125	137.5	137.5	150	162.5	162.5	175	175	187.5	187.5	200	200	212.5	212.5	225	225	237.5	237.5	250	250
L3	79.8	86.3	92.8	99.3	105.8	112.3	118.8	125.3	131.8	138.3	144.8	151.3	157.8	164.3	170.8	177.3	183.8	190.3	196.8	203.3	209.8	216.3	222.8	229.3
L4	18.5	21.5	18	21	18	21	17.5	20.5	23.5	20.5	23.5	20	23	20	23	19.5	22.5	19.5	22.5	19	22	19	22	18.5

SJ1000/2000/3000 Series

Dimensions: SJ2000 Series for D-sub Connector

SS5J2-60FD₂-[Stations] U(S, R, RS)

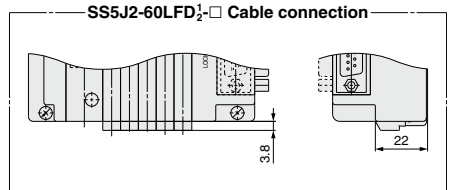
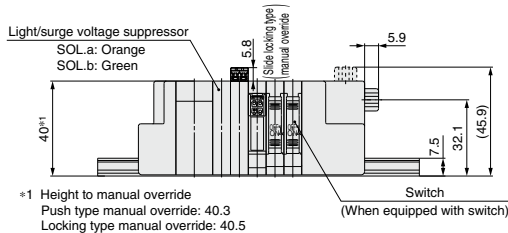
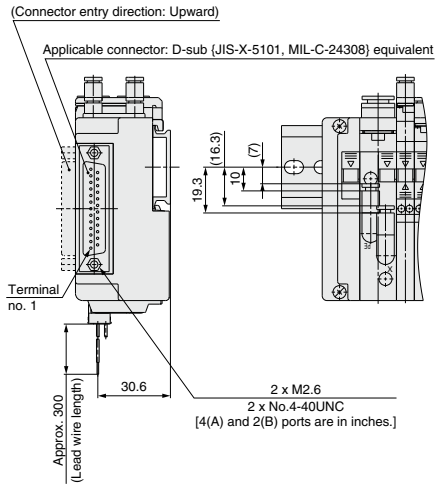
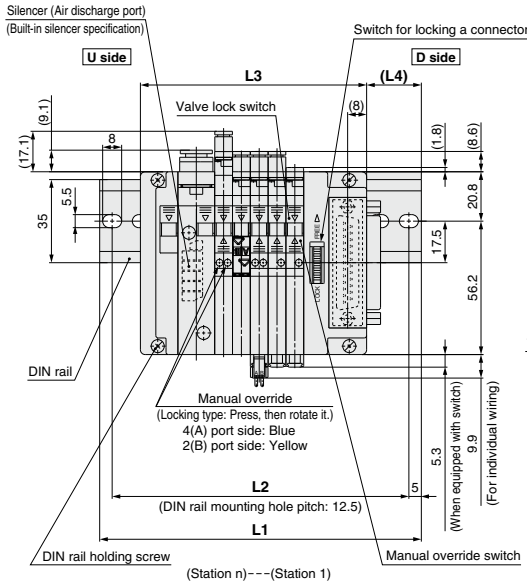
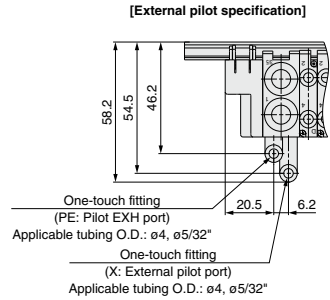
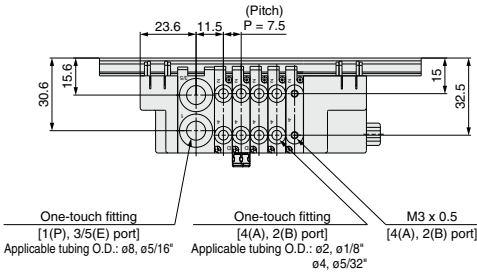

* For manifold dimensions including elbow fitting, refer to page 310.

L: Dimensions

n: Stations

L/n	1	2	3	4	5	6	7	8	9	10	11	12	13	14	15	16	17	18	19	20	21	22	23	24
L1	98	110.5	110.5	123	135.5	135.5	148	148	160.5	173	173	185.5	185.5	198	210.5	210.5	223	223	235.5	248	248	260.5	260.5	273
L2	87.5	100	100	112.5	125	125	137.5	137.5	150	162.5	162.5	175	175	187.5	200	200	212.5	212.5	225	237.5	237.5	250	250	262.5
L3	65.3	72.8	80.3	87.8	95.3	102.8	110.3	117.8	125.3	132.8	140.3	147.8	155.3	162.8	170.3	177.8	185.3	192.8	200.3	207.8	215.3	222.8	230.3	237.8
L4	19.5	22	18	20.5	23	19.5	22	18	20.5	23	19.5	22	18	20.5	23	19.5	22	18	20.5	23	19.5	22	18	20.5

Dimensions: SJ2000 Series for D-sub Connector

SS5J2-60FD₂ - [Stations] B(S, R, RS)

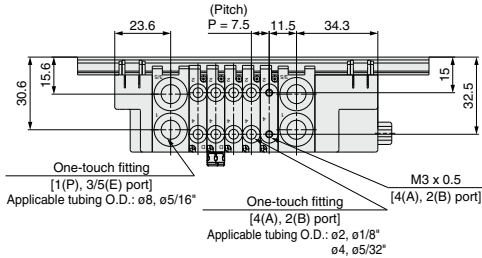

[External pilot specification]
 (There are piping of X and PE ports on both sides.)

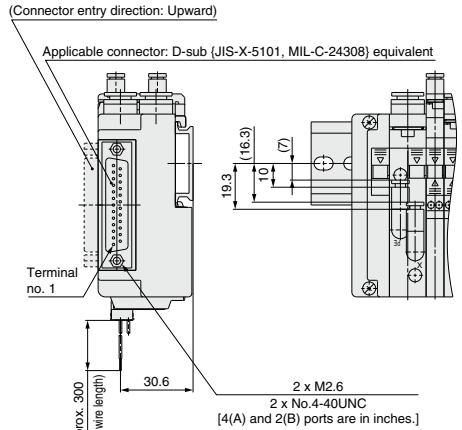
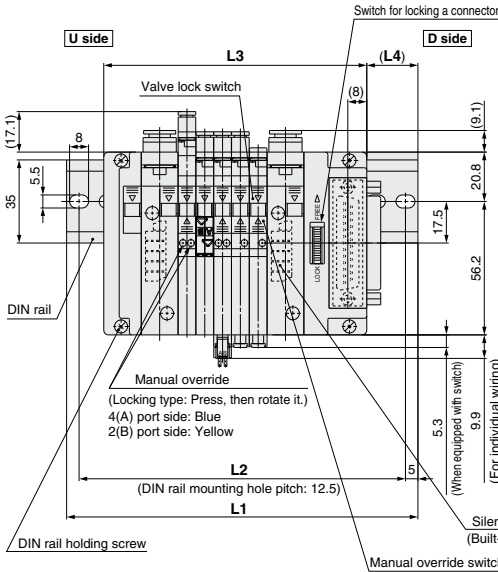
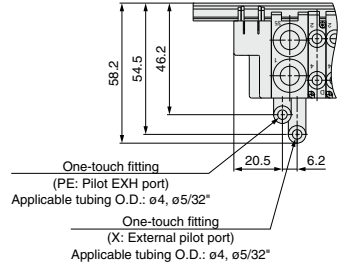

(Station n) ----- (Station 1)

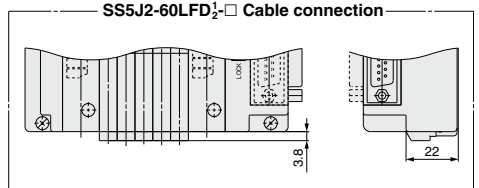
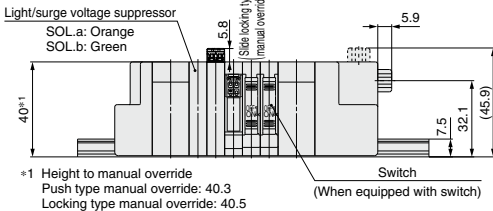

* For manifold dimensions including elbow fitting, refer to page 310.

L: Dimensions

n: Stations

L	1	2	3	4	5	6	7	8	9	10	11	12	13	14	15	16	17	18	19	20	21	22	23	24
L1	110.5	123	135.5	135.5	148	148	160.5	173	173	185.5	185.5	198	210.5	210.5	223	223	235.5	248	248	260.5	260.5	273	285.5	285.5
L2	100	112.5	125	125	137.5	137.5	150	162.5	162.5	175	175	187.5	200	200	212.5	212.5	225	237.5	237.5	250	250	262.5	275	275
L3	80.8	88.3	95.8	103.3	110.8	118.3	125.8	133.3	140.8	148.3	155.8	163.3	170.8	178.3	185.8	193.3	200.8	208.3	215.8	223.3	230.8	238.3	245.8	253.3
L4	18	20.5	23	19	21.5	18	20.5	23	19	21.5	18	20.5	23	19	21.5	18	20.5	23	19	21.5	18	20.5	23	19

SJ1000/2000/3000 Series

Dimensions: SJ3000 Series for D-sub Connector

SS5J3-60FD₂-[Stations]U(S, R, RS)

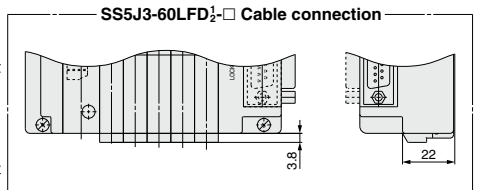
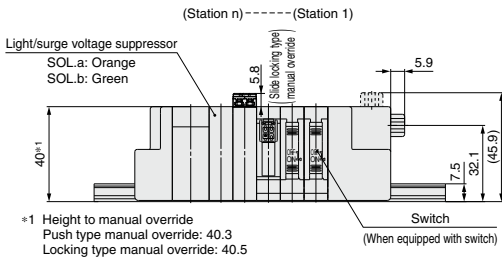
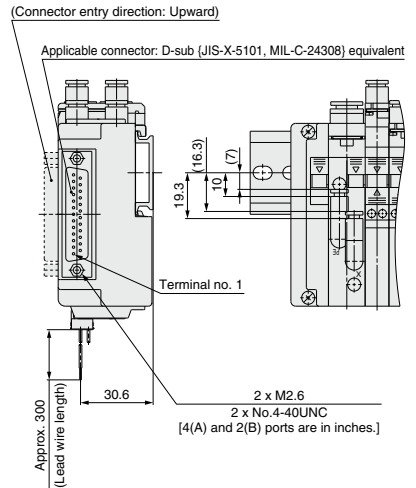
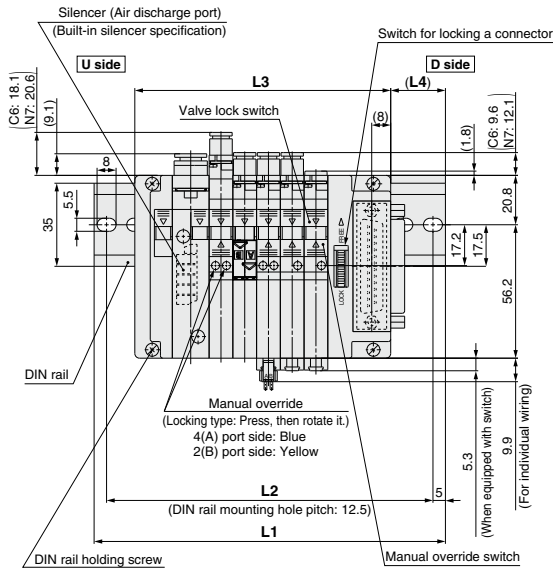
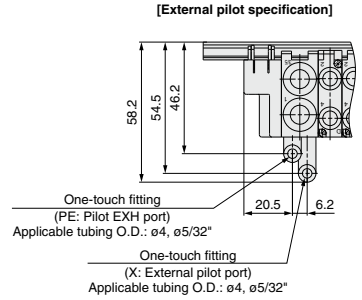
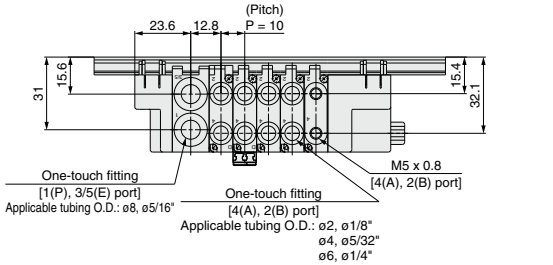

* For manifold dimensions including elbow fitting, refer to page 311.

L: Dimensions

n	1	2	3	4	5	6	7	8	9	10	11	12	13	14	15	16	17	18	19	20	21	22	23	24
L1	98	110.5	123	135.5	148	148	160.5	173	185.5	198	210.5	210.5	223	235.5	248	260.5	260.5	273	285.5	298	310.5	323	323	335.5
L2	87.5	100	112.5	125	137.5	137.5	150	162.5	175	187.5	200	200	212.5	225	237.5	250	250	262.5	275	287.5	300	312.5	312.5	325
L3	67.8	77.8	87.8	97.8	107.8	117.8	127.8	137.8	147.8	157.8	167.8	177.8	187.8	197.8	207.8	217.8	227.8	237.8	247.8	257.8	267.8	277.8	287.8	297.8
L4	18	19	20.5	21.5	22.5	17.5	18.5	20	21	22	23	18	19.5	20.5	21.5	22.5	17.5	19	20	21	22	23.5	18.5	19.5

Dimensions: SJ3000 Series for D-sub Connector

SS5J3-60FD₂-[Stations]B(S, R, RS)

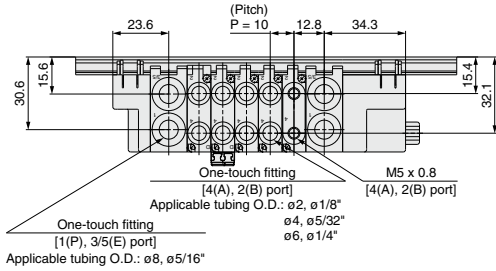

[External pilot specification]
 (There are piping of X and PE ports on both sides.)

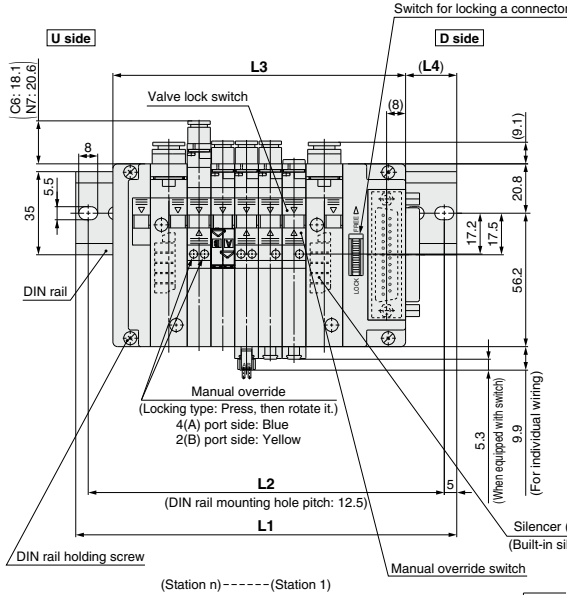
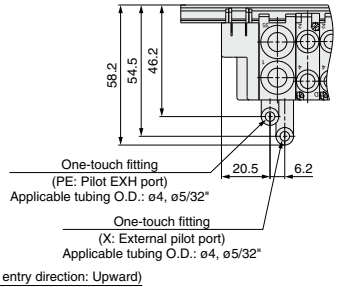

Applicable connector: D-sub [JIS-X-5101, MIL-C-24308] equivalent

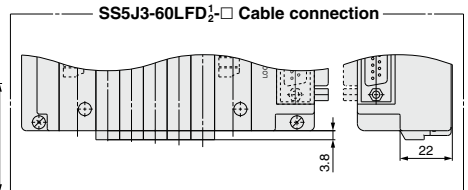
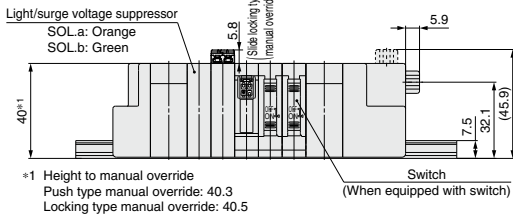
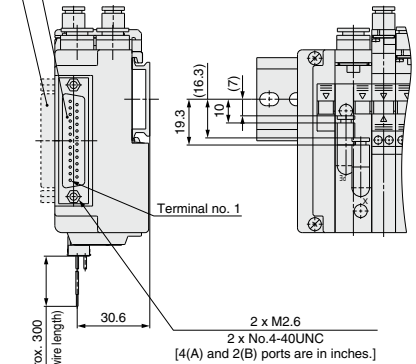

* For manifold dimensions including elbow fitting, refer to page 311.

L: Dimensions

n: Stations

L/n	1	2	3	4	5	6	7	8	9	10	11	12	13	14	15	16	17	18	19	20	21	22	23	24
L1	123	123	135.5	148	160.5	173	185.5	185.5	198	210.5	223	235.5	235.5	248	260.5	273	285.5	298	298	310.5	323	335.5	348	348
L2	112.5	112.5	125	137.5	150	162.5	175	175	187.5	200	212.5	225	225	237.5	250	262.5	275	287.5	287.5	300	312.5	325	337.5	337.5
L3	83.3	93.3	103.3	113.3	123.3	133.3	143.3	153.3	163.3	173.3	183.3	193.3	203.3	213.3	223.3	233.3	243.3	253.3	263.3	273.3	283.3	293.3	303.3	313.3
L4	22.5	17.5	19	20	21	22	23.5	18.5	19.5	20.5	21.5	23	18	19	20	21	22.5	23.5	18.5	19.5	20.5	22	23	18

SJ1000/2000/3000 Series

Dimensions: SJ1000/2000/3000 Mixed Manifold

SS5J3-M60FD₂-[Stations] U(S, R, RS)

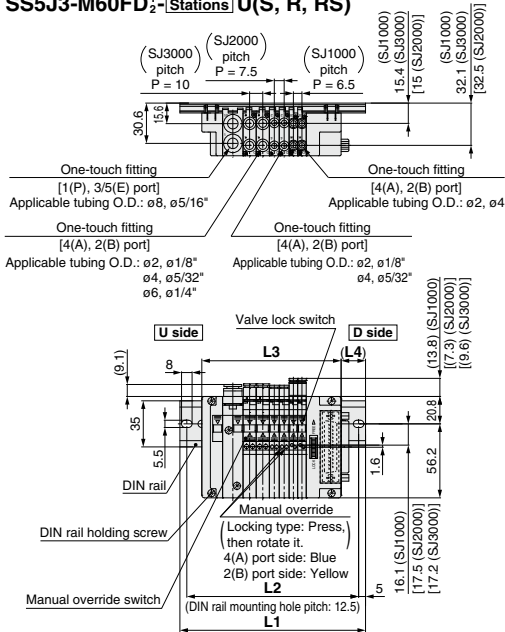

L dimension: Formula, L1 to L4
 $L3 = 6.5 \times n1 + 7.5 \times n2 + 10 \times n3 + 57.8$
 $M = (L3 + 9.9)/12.5 + 1$
 Decimal fractions are truncated.
 $L1 = M \times 12.5 + 23$
 $L2 = L1 - 10.5$
 $L4 = (L1 - L3)/2 + 1$

n1 = Number of SJ1000
 n2 = Number of SJ2000
 n3 = Number of SJ3000

* The dimensions of L1 to L4 for SS5J3-M60FD1/2-[Stations] D are the same as those of SS5J3-M60FD1/2-[Stations] U.

Applicable connector: D-sub (JIS-X-5101, MIL-C-24308) equivalent

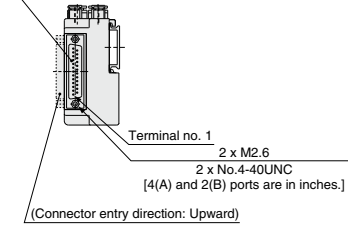

SS5J3-M60FD₁-[Stations] B(S, R, RS)

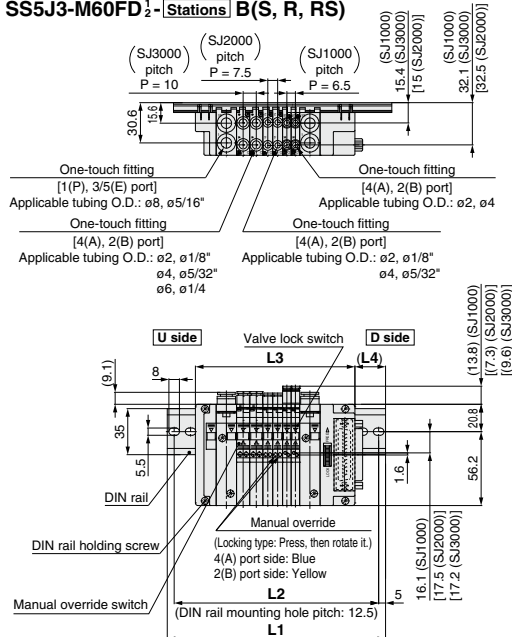

L3 = 6.5 x n1 + 7.5 x n2 + 10 x n3 + 73.3
 $M = (L3 + 9.9)/12.5 + 1$
 Decimal fractions are truncated.
 $L1 = M \times 12.5 + 23$
 $L2 = L1 - 10.5$
 $L4 = (L1 - L3)/2 + 1$

n1 = Number of SJ1000
 n2 = Number of SJ2000
 n3 = Number of SJ3000

Applicable connector: D-sub (JIS-X-5101, MIL-C-24308) equivalent

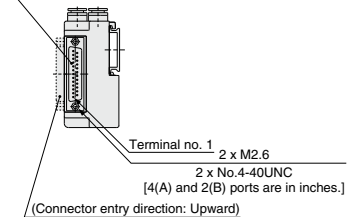

Dimensions: SJ1000 Series for Flat Ribbon Cable

SS5J1-60PD₂-[Stations]U(S, R, RS)

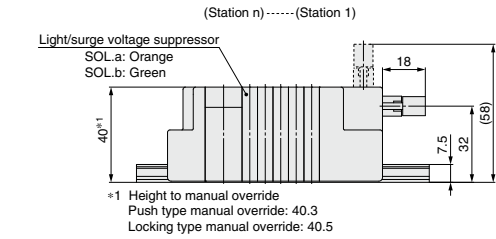
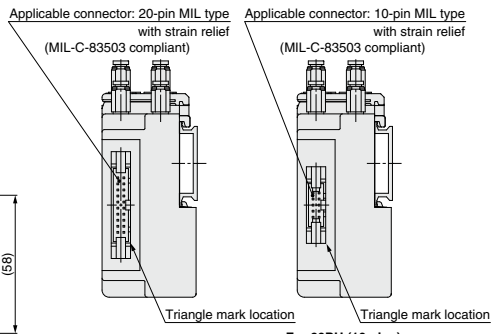
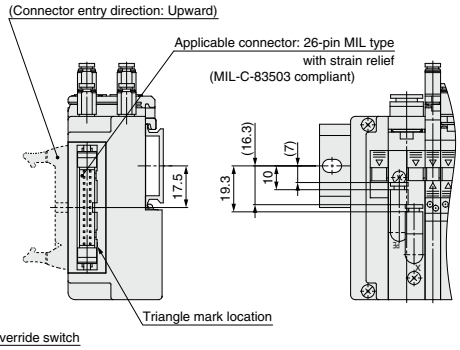
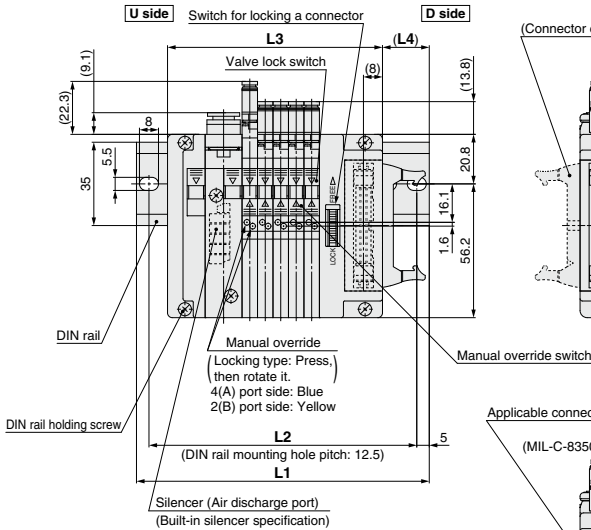
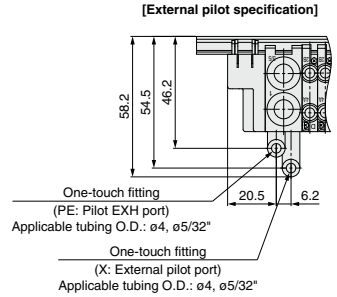
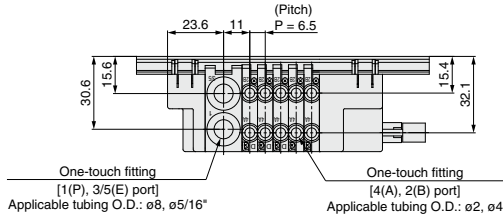

For 60GP (20 pins) For 60PH (10 pins)
 * Type 60GP and 60PH differ only in their connectors, and the L1 through L4 dimensions are the same as type 60P.

L: Dimensions

L	n	1	2	3	4	5	6	7	8	9	10	11	12	13	14	15	16	17	18	19	20	21	22	23	24	
L1	98	110.5	110.5	123	123	135.5	135.5	148	148	160.5	160.5	173	173	185.5	185.5	198	198	210.5	210.5	223	235.5	235.5	248	248	248	
L2	87.5	100	100	112.5	112.5	125	125	137.5	137.5	150	150	162.5	162.5	175	175	187.5	187.5	200	200	212.5	225	235.5	235.5	248	248	237.5
L3	64.3	70.8	77.3	83.8	90.3	96.8	103.3	109.8	116.3	122.8	129.3	135.8	142.3	148.8	155.3	161.8	168.3	174.8	181.3	187.8	194.3	200.8	207.3	213.8	213.8	213.8
L4	20	23	20	23	19.5	22.5	19.5	22.5	19	22	19	22	18.5	21.5	18.5	21.5	18	21	24	21	24	20.5	23.5	20.5	20.5	20.5

n: Stations

SJ1000/2000/3000 Series

Dimensions: SJ1000 Series for Flat Ribbon Cable

SS5J1-60PD₂-[Stations]B(S, R, RS)

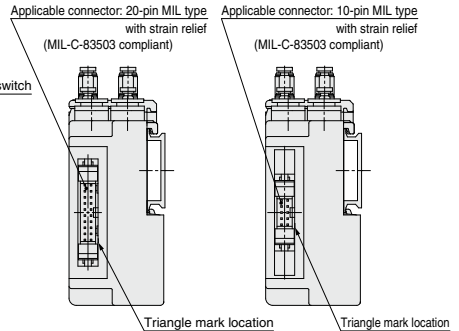
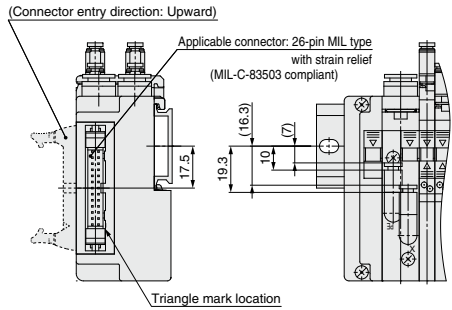
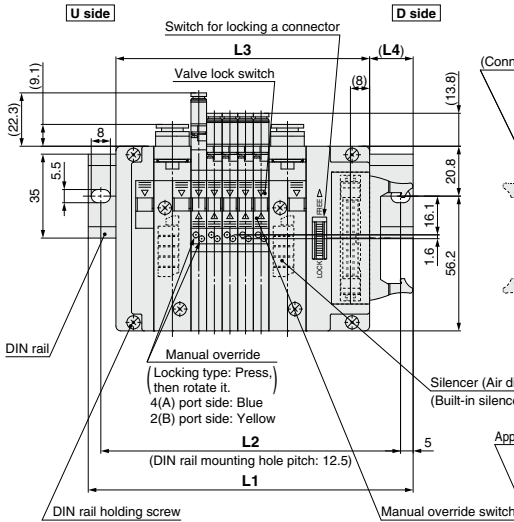
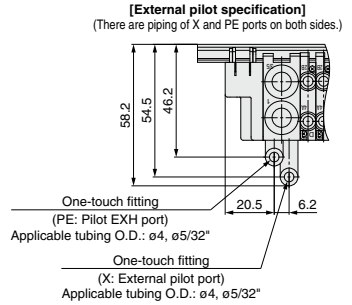
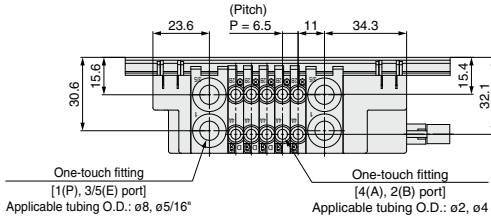

For 60PG (20 pins)

For 60PH (10 pins)

* Type 60PG and 60PH differ only in their connectors, and the L1 through L4 dimensions are the same as type 60P.

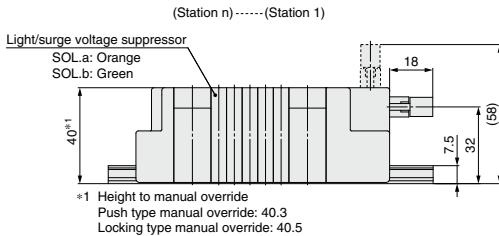

L: Dimensions

n: Stations

L \ n	1	2	3	4	5	6	7	8	9	10	11	12	13	14	15	16	17	18	19	20	21	22	23	24
L1	110.5	123	123	135.5	135.5	148	148	160.5	173	173	185.5	185.5	198	198	210.5	210.5	223	223	235.5	235.5	248	248	260.5	260.5
L2	100	112.5	112.5	125	125	137.5	137.5	150	162.5	162.5	175	175	187.5	187.5	200	200	212.5	212.5	225	225	237.5	237.5	250	250
L3	79.8	86.3	92.8	99.3	105.8	112.3	118.8	125.3	131.8	138.3	144.8	151.3	157.8	164.3	170.8	177.3	183.8	190.3	196.8	203.3	209.8	216.3	222.8	229.3
L4	18.5	21.5	18.5	21.5	18	21	24	21	24	20.5	23.5	20.5	23.5	20	23	20	23	19.5	22.5	19.5	22.5	19	22	19

Dimensions: SJ2000 Series for Flat Ribbon Cable

SS5J2-60PD₂-[Stations] U(S, R, RS)

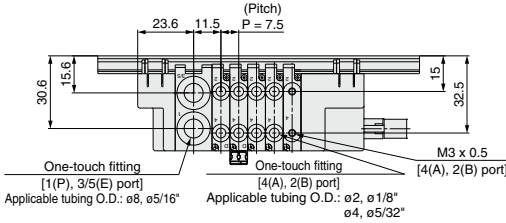

[External pilot specification]

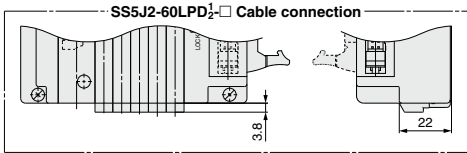
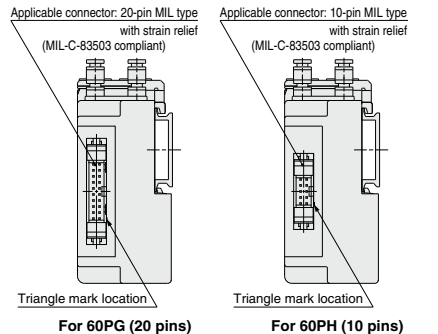
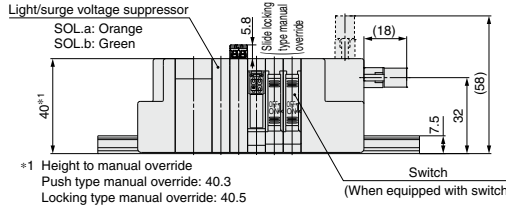
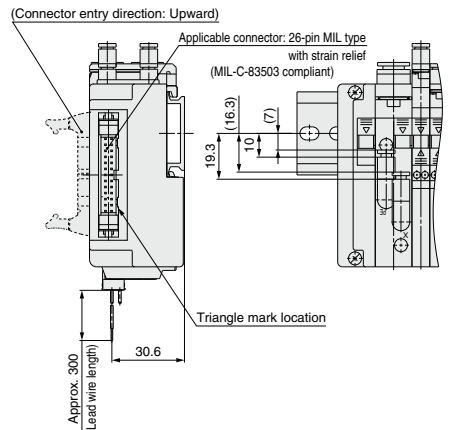
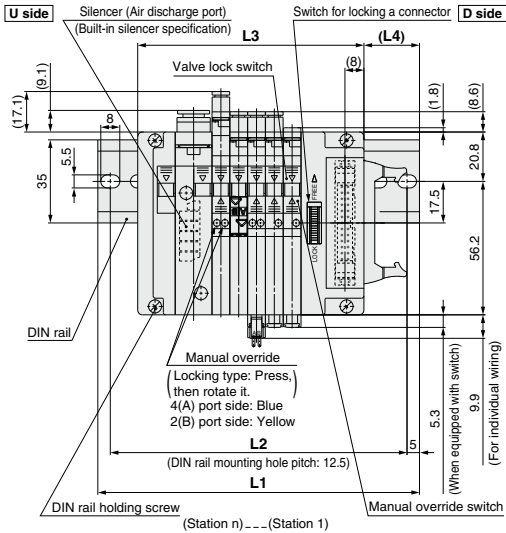
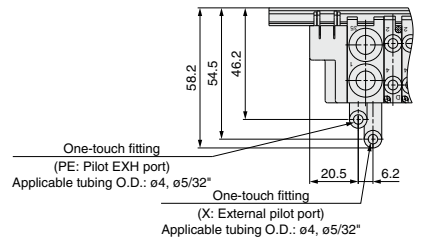

* Type 60PG and 60PH differ only in their connectors, and the L1 through L4 dimensions are the same as type 60P.
 * For manifold dimensions including elbow fitting, refer to page 310.

L: Dimensions

L	n	1	2	3	4	5	6	7	8	9	10	11	12	13	14	15	16	17	18	19	20	21	22	23	24
L1		98	110.5	110.5	123	135.5	135.5	148	148	160.5	173	173	185.5	185.5	198	210.5	210.5	223	223	235.5	248	248	260.5	260.5	273
L2		87.5	100	100	112.5	125	125	137.5	137.5	150	162.5	162.5	175	175	187.5	200	200	212.5	212.5	225	237.5	250	250	262.5	262.5
L3		65.3	72.8	80.3	87.8	95.3	102.8	110.3	117.8	125.3	132.8	140.3	147.8	155.3	162.8	170.3	177.8	185.3	192.8	200.3	207.8	215.3	222.8	230.3	237.8
L4		19.5	22	18.5	21	23.5	19.5	22	18.5	21	23.5	19.5	22	18.5	21	23.5	19.5	22	18.5	21	23.5	19.5	22	18.5	21

n: Stations

SJ1000/2000/3000 Series

Dimensions: SJ2000 Series for Flat Ribbon Cable

SS5J2-60PD₂ - Stations B(S, R, RS)

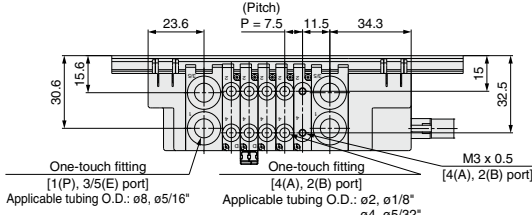

[External pilot specification]
(There are piping of X and PE ports on both sides.)

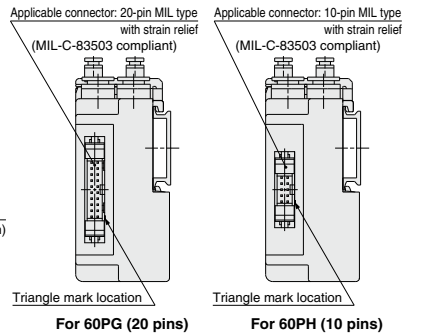
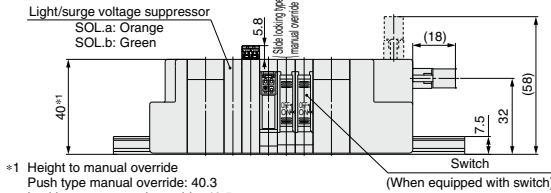
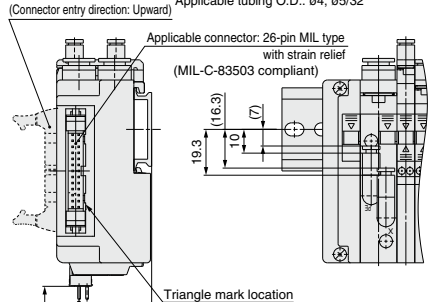
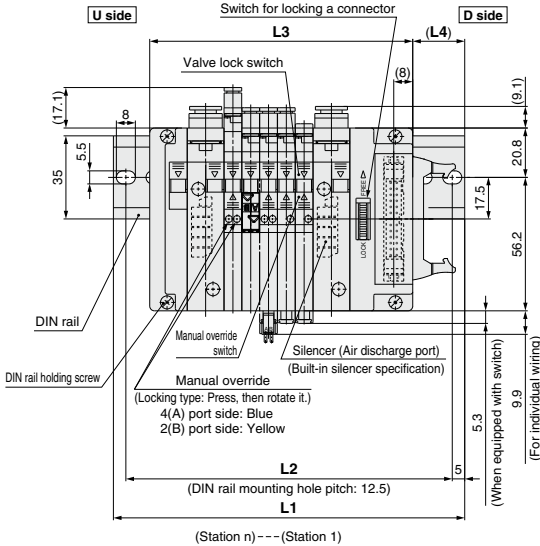
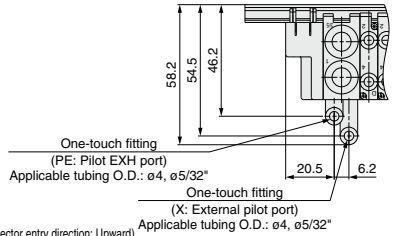

SS5J2-60LPD₂ - Cable connection

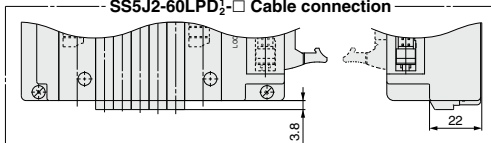

- * Type 60PG and 60PH differ only in their connectors, and the L1 through L4 dimensions are the same as type 60P.
- * For manifold dimensions including elbow fitting, refer to page 310.

L: Dimensions

L/n	1	2	3	4	5	6	7	8	9	10	11	12	13	14	15	16	17	18	19	20	21	22	23	24
L1	110.5	123	135.5	135.5	148	148	160.5	173	173	185.5	185.5	198	210.5	210.5	223	223	235.5	248	248	260.5	260.5	273	285.5	285.5
L2	106	112.5	125	125	137.5	137.5	150	162.5	162.5	175	175	187.5	200	200	212.5	212.5	225	237.5	237.5	250	250	262.5	275	275
L3	80.8	88.3	95.8	103.3	110.8	118.3	125.8	133.3	140.8	148.3	155.8	163.3	170.8	178.3	185.8	193.3	200.8	208.3	215.8	223.3	230.8	238.3	245.8	253.3
L4	18	20.5	23	19.5	22	18	20.5	23	19.5	22	18	20.5	23	19.5	22	18	20.5	23	19.5	22	18	20.5	23	19.5

n: Stations

Dimensions: SJ3000 Series for Flat Ribbon Cable

SS5J3-60PD₂ - Stations U(S, R, RS)

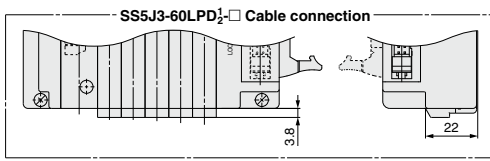
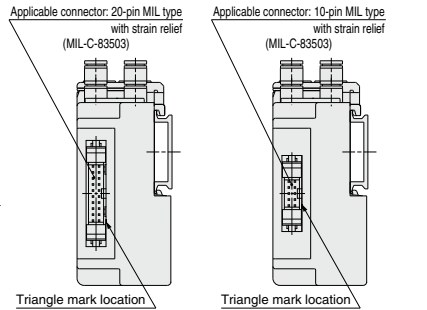
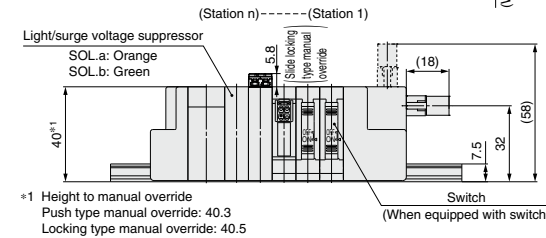
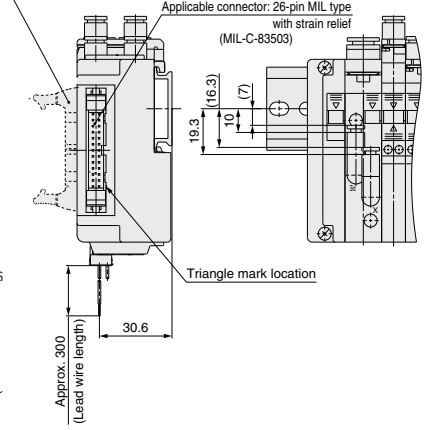
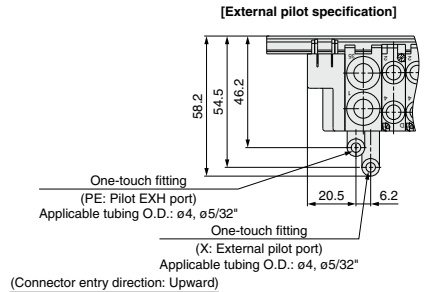
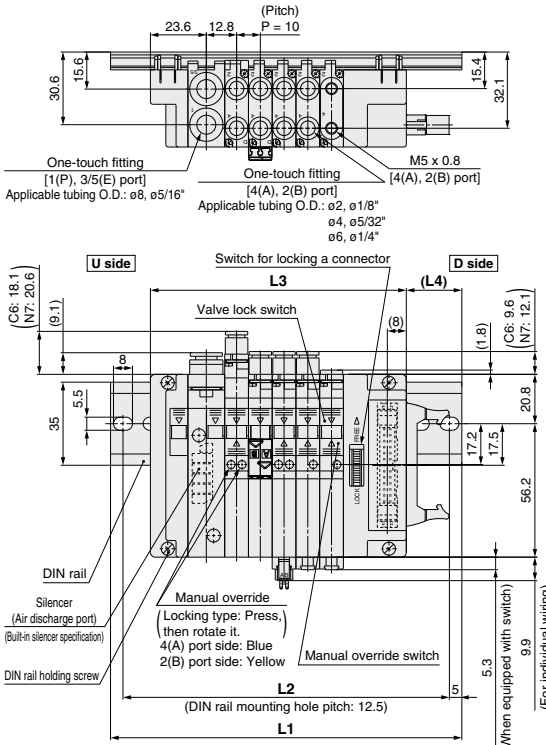

For 60PG (20 pins) For 60PH (10 pins)

* Type 60PG and 60PH differ only in their connectors, and the L1 through L4 dimensions are the same as type 60P.
 * For manifold dimensions including elbow fitting, refer to page 311.

L: Dimensions

L	n	1	2	3	4	5	6	7	8	9	10	11	12	13	14	15	16	17	18	19	20	21	22	23	24
L1	98	110.5	123	135.5	148	160.5	160.5	173	185.5	198	210.5	210.5	223	235.5	248	260.5	273	273	285.5	298	310.5	323	323	335.5	
L2	87.5	100	112.5	125	137.5	150	150	162.5	175	187.5	200	200	212.5	225	237.5	250	262.5	262.5	275	287.5	300	312.5	312.5	325	
L3	67.8	77.8	87.8	97.8	107.8	117.8	127.8	137.8	147.8	157.8	167.8	177.8	187.8	197.8	207.8	217.8	227.8	237.8	247.8	257.8	267.8	277.8	287.8	297.8	
L4	18.5	19.5	20.5	22	23	24	19	20	21.5	22.5	23.5	18.5	19.5	21	22	23	24	19	20.5	21.5	22.5	23.5	18.5	20	

n: Stations

SJ1000/2000/3000 Series

Dimensions: SJ3000 Series for Flat Ribbon Cable

SS5J3-60PD₂ - Stations B(S, R, RS)

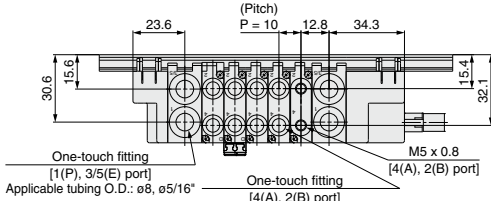

[External pilot specification]
(There are piping of X and PE ports on both sides.)

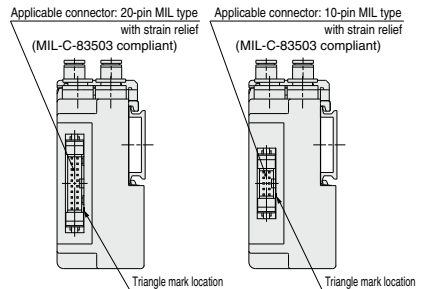
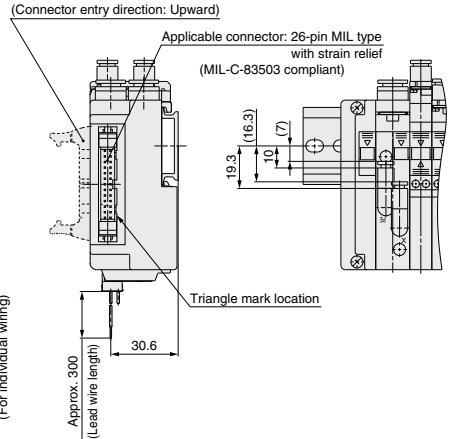
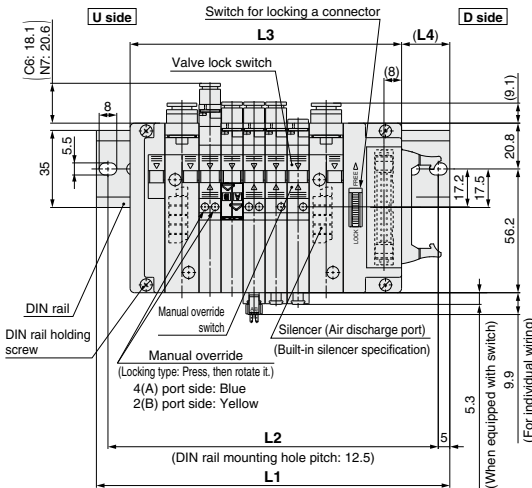
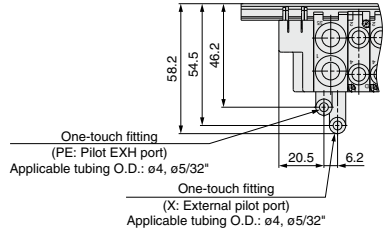

For 60PG (20 pins)

For 60PH (10 pins)

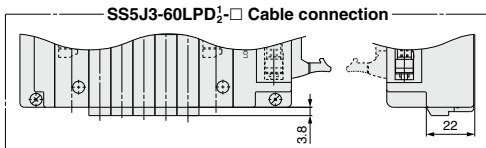

- * Type 60PG and 60PH differ only in their connectors, and the L1 through L4 dimensions are the same as type 60P.
- * For manifold dimensions including elbow fitting, refer to page 311.

L: Dimensions

L	n: Stations																							
	1	2	3	4	5	6	7	8	9	10	11	12	13	14	15	16	17	18	19	20	21	22	23	24
L1	123	135.5	135.5	148	160.5	173	185.5	185.5	198	210.5	223	235.5	248	248	260.5	273	285.5	298	298	310.5	323	335.5	348	348
L2	112.5	125	125	137.5	150	162.5	175	175	187.5	200	212.5	225	237.5	237.5	250	262.5	275	287.5	287.5	300	312.5	325	337.5	337.5
L3	83.3	93.3	103.3	113.3	123.3	133.3	143.3	153.3	163.3	173.3	183.3	193.3	203.3	213.3	223.3	233.3	243.3	253.3	263.3	273.3	283.3	293.3	303.3	313.3
L4	23	24	19	20.5	21.5	22.5	23.5	18.5	20	21	22	23	24.5	19.5	20.5	21.5	22.5	24	19	20	21	22	23.5	18.5

Dimensions: SJ1000/2000/3000 Mixed Manifold

SS5J3-M60PD₂-[Stations]U(S, R, RS)

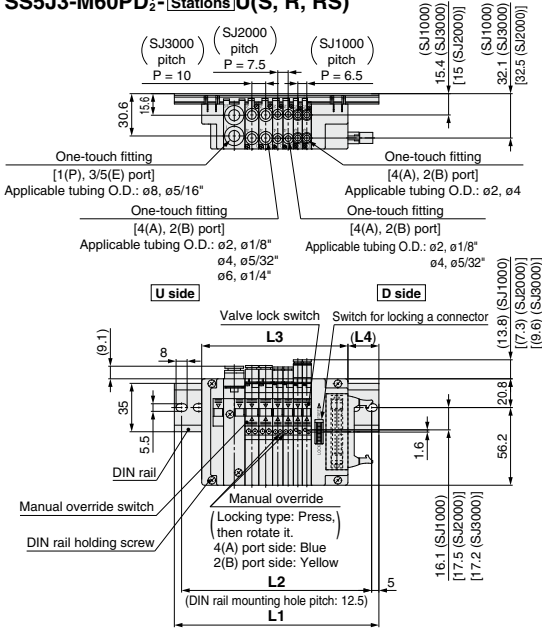

L dimension: Formula, L1 to L4
 $L3 = 6.5 \times n1 + 7.5 \times n2 + 10 \times n3 + 57.8$
 $M = (L3 + 10.6)/12.5 + 1$
 Decimal fractions are truncated.
 $L1 = M \times 12.5 + 23$
 $L2 = L1 - 10.5$
 $L4 = (L1 - L3)/2 + 1.3$

n1 = Number of SJ1000
 n2 = Number of SJ2000
 n3 = Number of SJ3000

* The dimensions of L1 to L4 for SS5J3-M60PD1/2-[Stations]D are the same as those of SS5J3-M60PD1/2-[Stations]U.

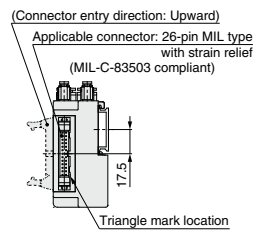

SS5J3-M60PD₂-[Stations]B(S, R, RS)

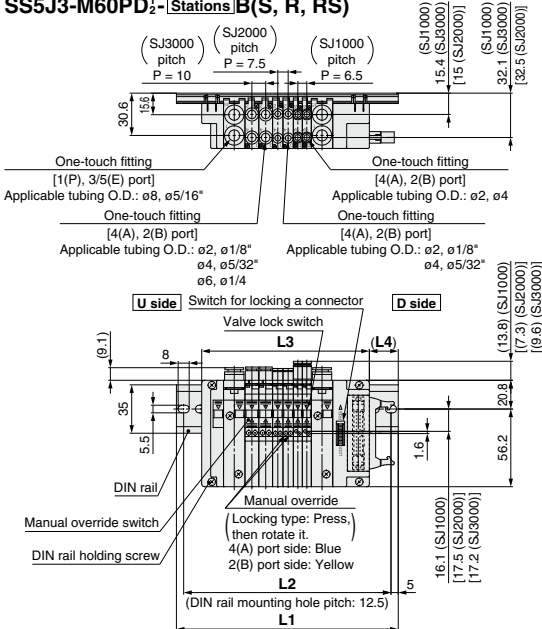

L dimension: Formula, L1 to L4
 $L3 = 6.5 \times n1 + 7.5 \times n2 + 10 \times n3 + 73.3$
 $M = (L3 + 10.6)/12.5 + 1$
 Decimal fractions are truncated
 $L1 = M \times 12.5 + 23$
 $L2 = L1 - 10.5$
 $L4 = (L1 - L3)/2 + 1.3$

n1 = Number of SJ1000
 n2 = Number of SJ2000
 n3 = Number of SJ3000

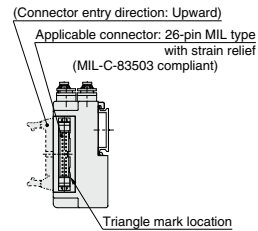

SJ1000/2000/3000 Series

Dimensions: SJ2000 Series with Elbow Fittings

SS5J2-60FD₂-(Stations)U₁

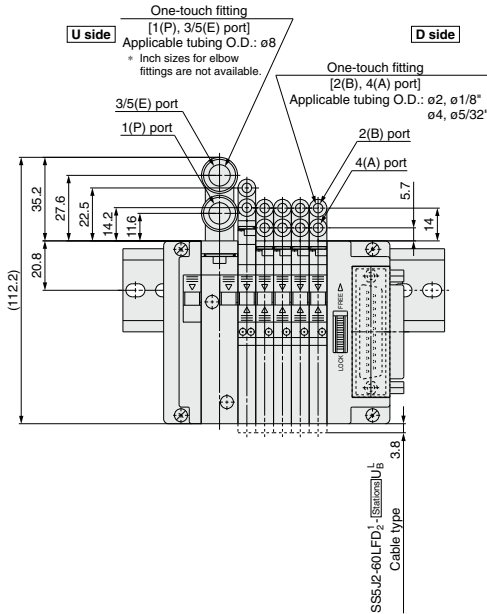
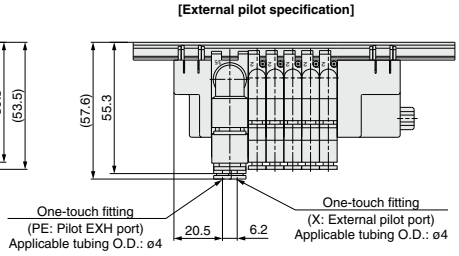
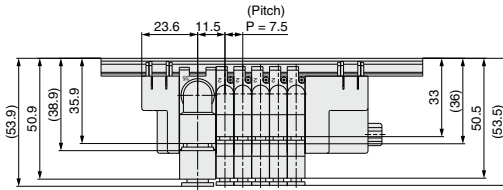

[SUP/EXH block (External pilot specification)]

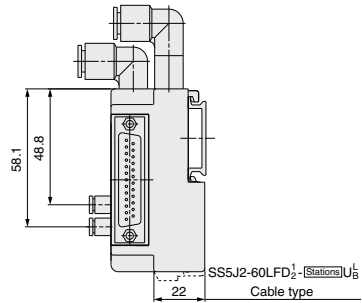

Downward (B type)

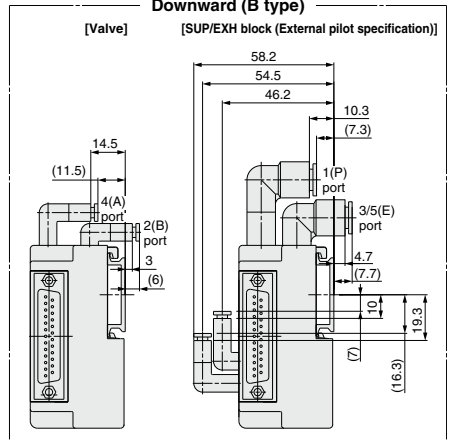

(Station n) --- (Station 1)

Dimensions: SJ3000 Series with Elbow Fittings

SS5J3-60FD₂-(Stations)U₆

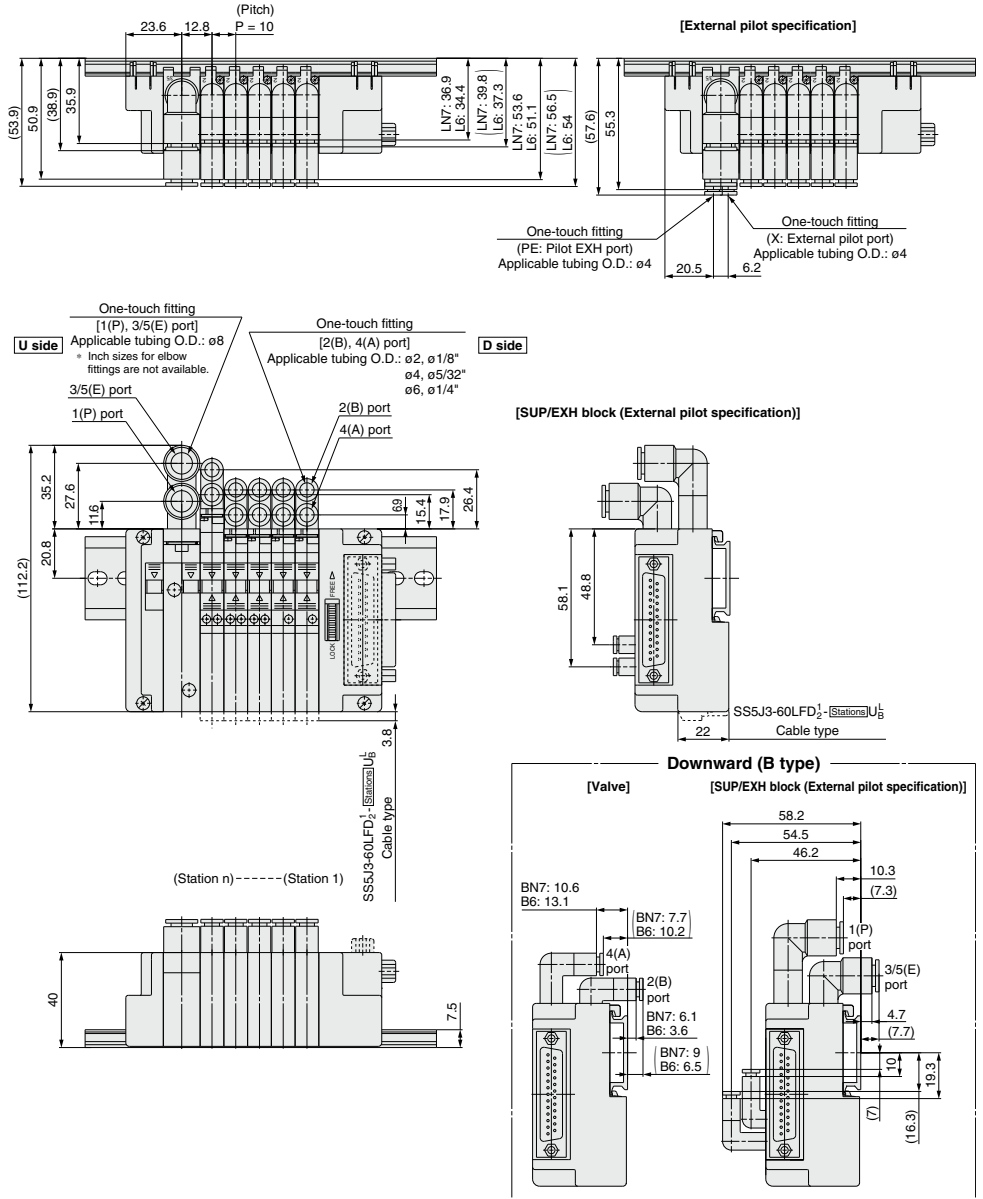

Plug-in Connector Type EX180 Integrated Type (For Output) Serial Transmission System



Type **60S**

SJ1000/2000/3000 Series

An order cannot be placed with only the manifold part no. Be sure to order solenoid valves for mounting at the same time while referring to the ordering example.

How to Order

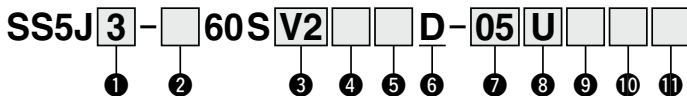

1 Series

1	SJ1000
2	SJ2000
3	SJ3000 (SJ1000/2000/3000 mixed ^{*1})

^{*1} Select "3" for the combination of SJ1000 and SJ2000 valves.

2 Mixed mounting type

Nil	Standard ^{*1}
M	Mixed mounting ^{*2}

^{*1} For SJ1000, 2000, and 3000 series valves, select "Nil" when only using a single series.

^{*2} Select "M" when SJ1000, SJ2000, or SJ3000 series valves will be mounted on the same manifold base together.

3 Component module

0	Without SI unit
V2	CC-Link (32 points)
Q2	DeviceNet® (32 points)
Q3	DeviceNet® (16 points)

^{*} Please contact SMC for SI unit specifications.

4 Communication connector

Nil	T-branch type
A	Straight type

^{*} The communication connector and power connector are shipped together with the manifold. The power connector is only available for the straight type.

5 SI unit common specification

Nil	Positive common
N	Negative common

6 Unit mounting position

D	D side
---	--------

7 Valve stations

Symbol	Stations	Note
01	1 station	Up to 32 solenoids can be selected.
⋮	⋮	
32	32 stations	

^{*} This number also includes the blanking block assembly. Since single and double wiring are available for the blanking block assembly, select a model compatible with the valve wiring specification to be used. (Refer to page 34.)

8 SUP/EXH block mounting position

U	U side
D	D side
B	Both sides
M ^{*1}	Special specifications

^{*1} Specify the required specifications (including port sizes other than ø8) on the manifold specification sheet.

9 Pilot type

Nil	Internal pilot
S	Internal pilot, Built-in silencer
R	External pilot
RS	External pilot, Built-in silencer

^{*} There is no need to enter anything when the SUP/EXH block mounting position "M" is selected.

^{*} The 3/5(E) port is plugged for the built-in silencer type.

10 SUP/EXH block fitting specification

Nil	Straight fitting With external pilot spec. X, PE port: Elbow fitting	
L	Elbow fitting (Upward) With external pilot spec. X, PE port: Straight fitting	
B	Elbow fitting (Downward) With external pilot spec. X, PE port: Elbow fitting	

^{*} There is no need to enter anything when the SUP/EXH block mounting position "M" is selected.

How to Order Manifold Assembly

Ordering example (SS5J3-60SV2□-□)

Double solenoid, individual wiring/
lead wire length 300 mm (24 VDC)
SJ3260-5MZ-C6 (1 set)

Double solenoid, with switch (24 VDC)
SJ3260-5CZJ-C6 (1 set)

Double solenoid (24 VDC)
SJ3260-5CU-C6 (2 sets)

Single solenoid (24 VDC)
SJ3160-5CU-C6 (2 sets)

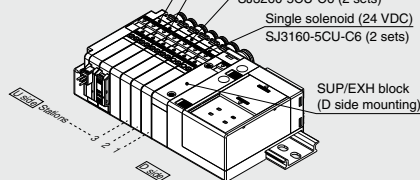

SS5J3-60SV2D-06D 1 set (Manifold part no.)
^{*} SJ3160-5CU-C6 2 sets (Single solenoid part no.)
^{*} SJ3260-5CU-C6 2 sets (Double solenoid part no.)
^{*} SJ3260-5CZJ-C6 1 set (Double solenoid, with switch part no.)
^{*} SJ3260-5MZ-C6 1 set (Double solenoid, individual wiring/
lead wire length 300 mm part no.)

—The asterisk denotes the symbol for the assembly.
Prefix it to the part numbers of the solenoid valve, etc.

• For the valve arrangement, the valve closest to the D side is considered the 1st station.
• Under the manifold part number, state the valves to be mounted in order starting with the 1st station as shown in the figure. If the arrangement becomes too complicated, specify the details on a manifold specification sheet.

^{*} When ordering a manifold, specify the part nos. of the valves to be mounted on it. (An order cannot be placed with only the manifold part no.)

11 DIN rail length specified

Nil	Standard length
2	2 stations Specify a length
⋮	⋮ longer than that of
32	32 stations the standard rail.

^{*} Specify the number of valve stations without exceeding the max. number of stations.

SI Unit Part Nos.

Symbol	Component module/Communication connector	Common specification	SI unit part no.
V2	CC-Link (32 points)	NPN output (Positive common)	EX180-SMJ3
V2N	T-branch type	PNP output (Negative common)	EX180-SMJ3
V2A	CC-Link (32 points)	NPN output (Positive common)	EX180-SMJ3A
V2AN	Straight type	PNP output (Negative common)	EX180-SMJ3A
Q2	DeviceNet® (32 points)	NPN output (Positive common)	EX180-SMJ5A
Q2N	T-branch type	PNP output (Negative common)	EX180-SDN5
Q2A	DeviceNet® (32 points)	NPN output (Positive common)	EX180-SDN3A
Q2AN	Straight type	PNP output (Negative common)	EX180-SDN5A
Q3	DeviceNet® (16 points)	NPN output (Positive common)	EX180-SDN4
Q3N	T-branch type	PNP output (Negative common)	EX180-SDN6
Q3A	DeviceNet® (16 points)	NPN output (Positive common)	EX180-SDN4A
Q3AN	Straight type	PNP output (Negative common)	EX180-SDN6A

	Item	Specification
Power source for driving valve	Non-polar	24 VDC +10%/–5%
	With power-saving circuit (Continuous duty)	24 VDC +10%/0%

For details on the EX180 Integrated Type (For Output) Serial Transmission System, refer to the Web Catalog and the Operation Manual. Please download the Operation Manual via the SMC website: <https://www.smcworld.com>

How to Order Solenoid Valves

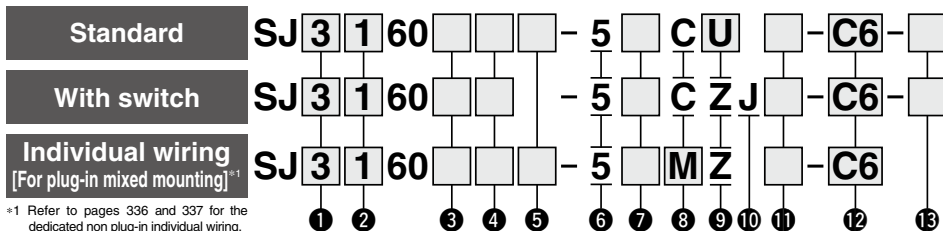

¹ Refer to pages 336 and 337 for the dedicated non plug-in individual wiring.

1 Series

1	SJ1000
2	SJ2000
3	SJ3000

2 Type of actuation

1	2-position single solenoid
2	2-position double solenoid
3	3-position closed center
4	3-position exhaust center
5	3-position pressure center
A	Dual 3-port valve: N.C./N.C.
B	Dual 3-port valve: N.O./N.O.
C	Dual 3-port valve: N.C./N.O.

* Refer to pages 281 to 284 for the symbol.

3 Pilot type

Nil	Internal pilot
R	External pilot

* External pilot specification is not applicable for 4-position dual 3-port valves.

4 Back pressure check valve

Nil	None
K	Built-in

* Back pressure check valve is not applicable for 3-position valve.

5 Coil type

Symbol	Coil type	SJ1000	SJ2000	SJ3000
Nil	Standard	—	●	●
T	With power-saving circuit (Continuous duty type)	●	●	●

* Be sure to select the power-saving circuit type if the valve is to be continuously energized for long periods of time.
 * For the SJ1000 series, only the power-saving circuit type is available.

6 Rated voltage

5	24 VDC
---	--------

7 Common specification

Nil	Positive common
N	Negative common

* For the non-polar type, there is no need to select a symbol.
 * When the standard valve and valve with a switch are used, select a common specification that matches the SJ unit common specification.

8 Connector entry

	C: Dedicated for centralized wiring	M: Individual wiring. With lead wire Length 300 mm	MM: Individual wiring. Without lead wire (With connector, socket)	MO: Individual wiring. Without connector
Symbol				
SJ1000	●	—	—	—
SJ2000	●	—	—	●
SJ3000	●	●	●	●

* Connector entries with the symbol "M□" cannot use the switch signal from the common wiring on the manifold. For details, refer to the "Connector Wiring Diagram" on page 280.
 * When ordering a connector assembly separately, refer to pages 283 and 284.

11 Manual override

Symbol/Specification	SJ1000	SJ2000	SJ3000
Nil: Non-locking push type	●	●	●
D: Push-turn locking slotted type	●	●	●
F: Slide locking type	—	●	●

12 A, B port size

Metric/One-touch fitting

Symbol	A, B port	SJ1000	SJ2000	SJ3000
C2	Straight	ø2	●	●
C4	Straight	ø4	●	●
C6	Straight	ø6	—	—
L2	Elbow	ø2	—	●
L4		ø4	—	●
L6		ø6	—	●
B2	Downward entry	ø2	—	●
B4		ø4	—	●
B6		ø6	—	●

Thread piping

Symbol	A, B port	SJ1000	SJ2000	SJ3000
M3	M3 x 0.5	—	●	—
M5	M5 x 0.8	—	—	●

Inch/One-touch fitting

Symbol	A, B port	SJ1000	SJ2000	SJ3000
N1	Straight	ø1/8"	—	●
N3		ø5/32"	—	●
N7		ø1/4"	—	●
LN1	Downward entry	ø1/8"	—	●
LN3		ø5/32"	—	●
LN7		ø1/4"	—	●
BN1	Elbow	ø1/8"	—	●
BN3		ø5/32"	—	●
BN7		ø1/4"	—	●

13 Single solenoid wiring specification

Nil	Single wiring
D	Double wiring

* There is no need to enter anything for 2-position double, 3-position, and 4-position solenoid valves. Select this when the unused numbers to wiring are set. Refer to page 280 for details.

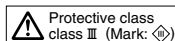

SJ1000/2000/3000 Series

Dimensions: SJ1000 Series for EX180 Integrated Type (For Output) Serial Transmission System

SS5J1-60S□□-□ Stations U(S, R, RS)

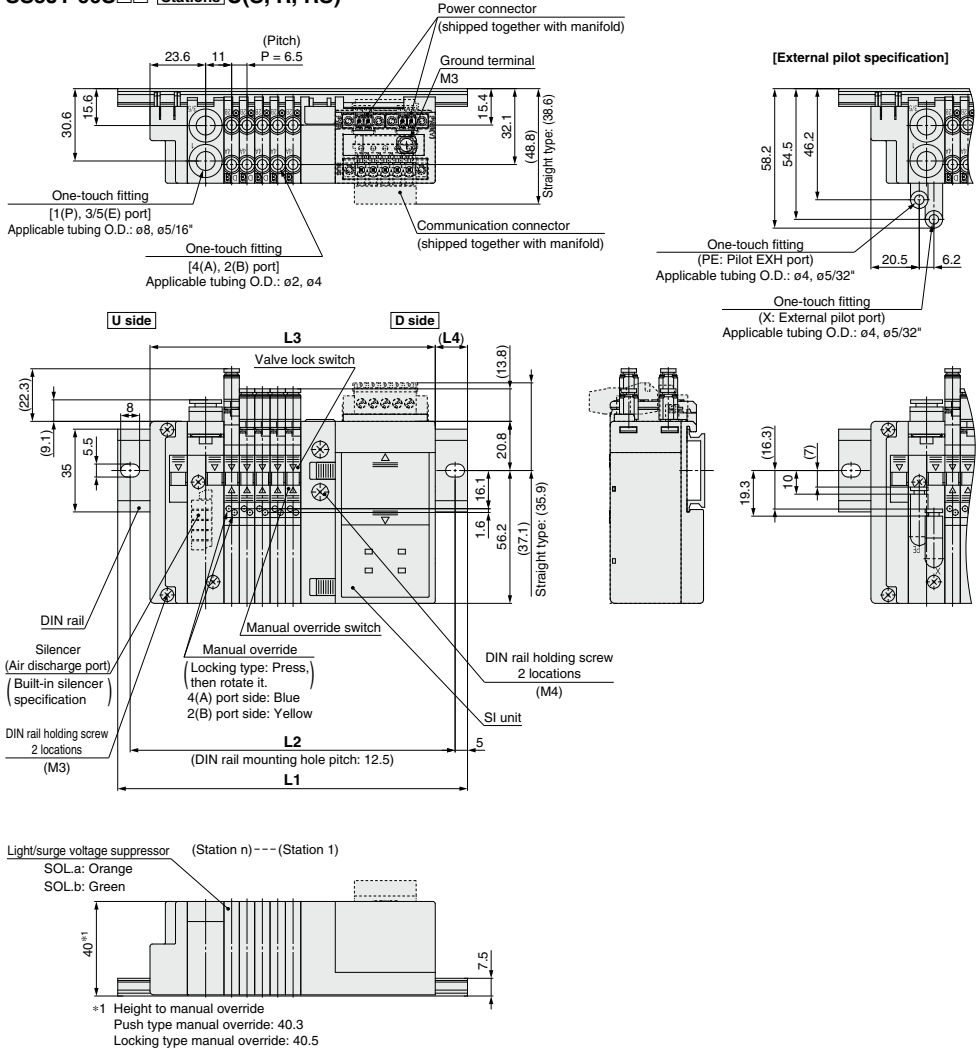

L: Dimensions

n: Stations

L	n	1	2	3	4	5	6	7	8	9	10	11	12	13	14	15	16
L1	123	135.5	135.5	148	148	160.5	160.5	173	173	185.5	185.5	198	198	210.5	210.5	223	
L2	112.5	125	125	137.5	137.5	150	150	162.5	162.5	175	175	187.5	187.5	200	200	212.5	
L3	94.7	101.2	107.7	114.2	120.7	127.2	133.7	140.2	146.7	153.2	159.7	166.2	172.7	179.2	185.7	192.2	
L4	14	17	14	17	13.5	16.5	13.5	16.5	13	16	13	16	12.5	15.5	12.5	15.5	
L	n	17	18	19	20	21	22	23	24	25	26	27	28	29	30	31	32
L1	223	235.5	235.5	248	248	260.5	273	273	285.5	285.5	298	298	310.5	310.5	323	323	
L2	212.5	225	225	237.5	237.5	250	262.5	262.5	275	275	287.5	287.5	300	300	312.5	312.5	
L3	198.7	205.2	211.7	218.2	224.7	231.2	237.7	244.2	250.7	257.2	263.7	270.2	276.7	283.2	289.7	296.2	
L4	12	15	12	15	11.5	14.5	17.5	14.5	17.5	14	17	14	17	13.5	16.5	13.5	

Dimensions: SJ1000 Series for EX180 Integrated Type (For Output) Serial Transmission System

SS5J1-60S□□- Stations B(S, R, RS)

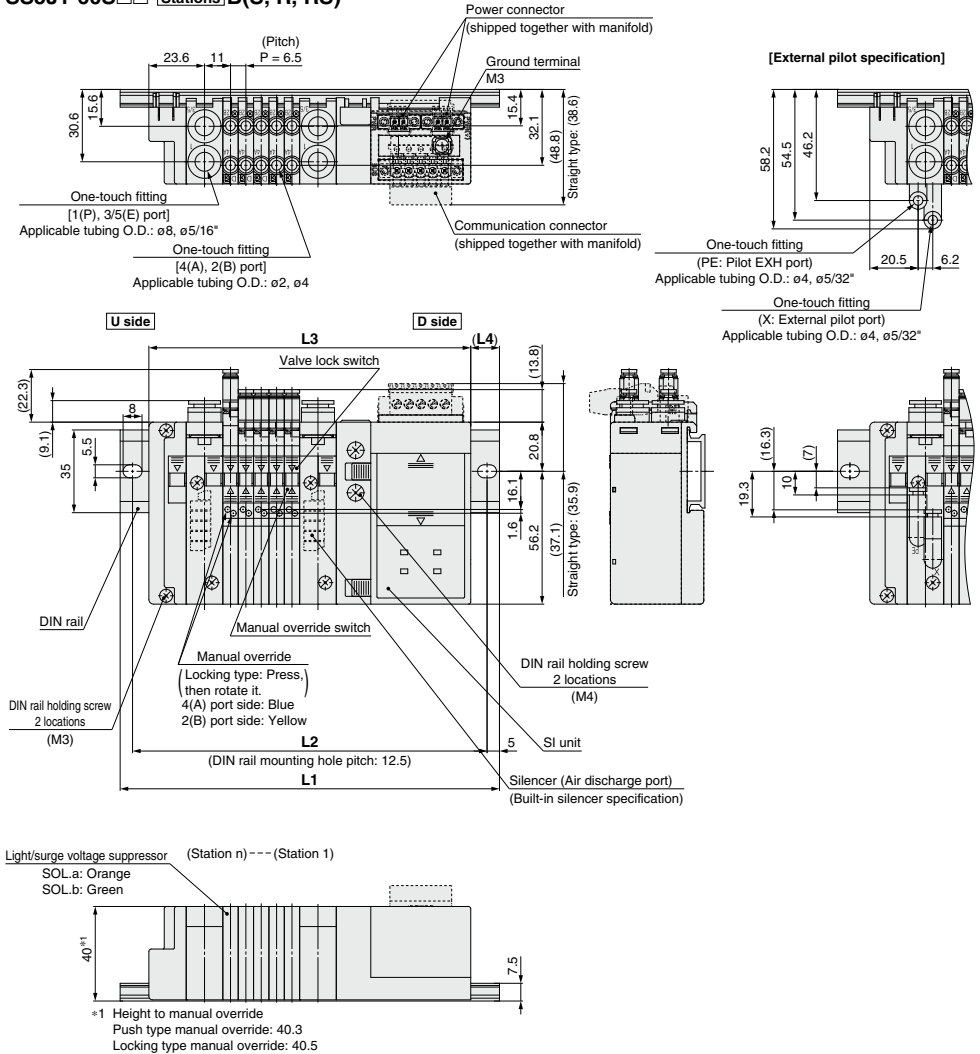

L: Dimensions

n: Stations

L	n	1	2	3	4	5	6	7	8	9	10	11	12	13	14	15	16
L1		135.5	148	148	160.5	160.5	173	173	185.5	185.5	198	210.5	210.5	223	223	235.5	235.5
L2		125	137.5	137.5	150	150	162.5	162.5	175	175	187.5	200	200	212.5	212.5	225	225
L3		110.2	116.7	123.2	129.7	136.2	142.7	149.2	155.7	162.2	168.7	175.2	181.7	188.2	194.7	201.2	207.7
L4		12.5	15.5	12.5	15.5	12	15	12	15	11.5	14.5	17.5	14.5	17.5	14	17	14

L	n	17	18	19	20	21	22	23	24	25	26	27	28	29	30	31	32
L1		248	248	260.5	260.5	273	273	285.5	285.5	298	298	310.5	310.5	323	323	335.5	335.5
L2		237.5	237.5	250	250	262.5	262.5	275	275	287.5	287.5	300	300	312.5	312.5	325	325
L3		214.2	220.7	227.2	233.7	240.2	246.7	253.2	259.7	266.2	272.7	279.2	285.7	292.2	298.7	305.2	311.7
L4		17	13.5	16.5	13.5	16.5	13	16	13	16	12.5	15.5	12.5	15.5	12	15	12

SJ1000/2000/3000 Series

Dimensions: SJ2000 Series for EX180 Integrated Type (For Output) Serial Transmission System

SS5J2-60S □ □ -Stations U(S, R, RS)

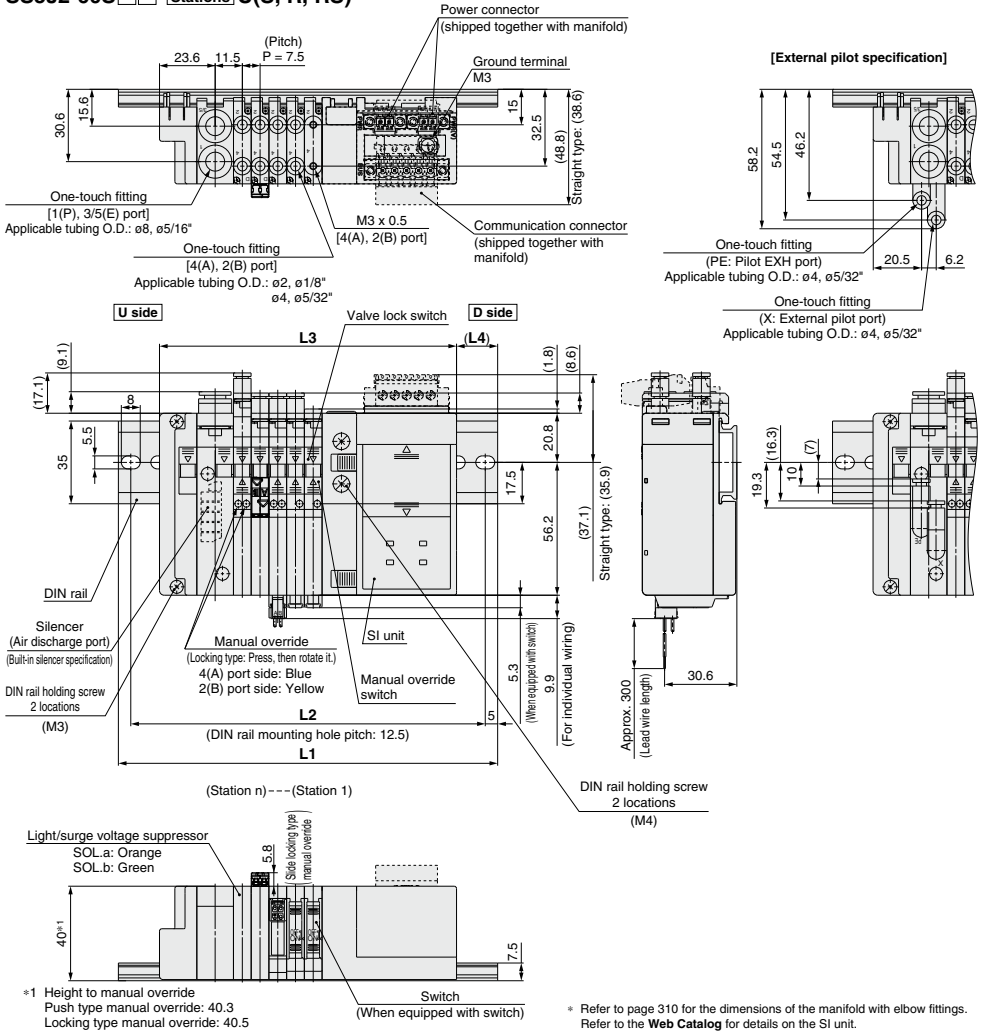

L: Dimensions

n: Stations

L	n	1	2	3	4	5	6	7	8	9	10	11	12	13	14	15	16
L1	123	135.5	135.5	148	160.5	160.5	173	173	185.5	198	198	210.5	210.5	223	235.5	235.5	
L2	112.5	125	125	137.5	150	150	162.5	162.5	175	187.5	187.5	200	200	212.5	225	225	
L3	95.7	103.2	110.7	118.2	125.7	133.2	140.7	148.2	155.7	163.2	170.7	178.2	185.7	193.2	200.7	208.2	
L4	13.5	16	12.5	15	17.5	13.5	16	12.5	15	17.5	13.5	16	12.5	15	17.5	13.5	
L	n	17	18	19	20	21	22	23	24	25	26	27	28	29	30	31	32
L1	248	248	260.5	273	273	285.5	285.5	298	310.5	310.5	323	323	335.5	348	348	360.5	
L2	237.5	237.5	250	262.5	262.5	275	275	287.5	300	300	312.5	312.5	325	337.5	337.5	350	
L3	215.7	223.2	230.7	238.2	245.7	253.2	260.7	268.2	275.7	283.2	290.7	298.2	305.7	313.2	320.7	328.2	
L4	16	12.5	15	17.5	13.5	16	12.5	15	17.5	13.5	16	12.5	15	17.5	13.5	16	

Dimensions: SJ2000 Series for EX180 Integrated Type (For Output) Serial Transmission System

SS5J2-60S □ □ -Stations B(S, R, RS)

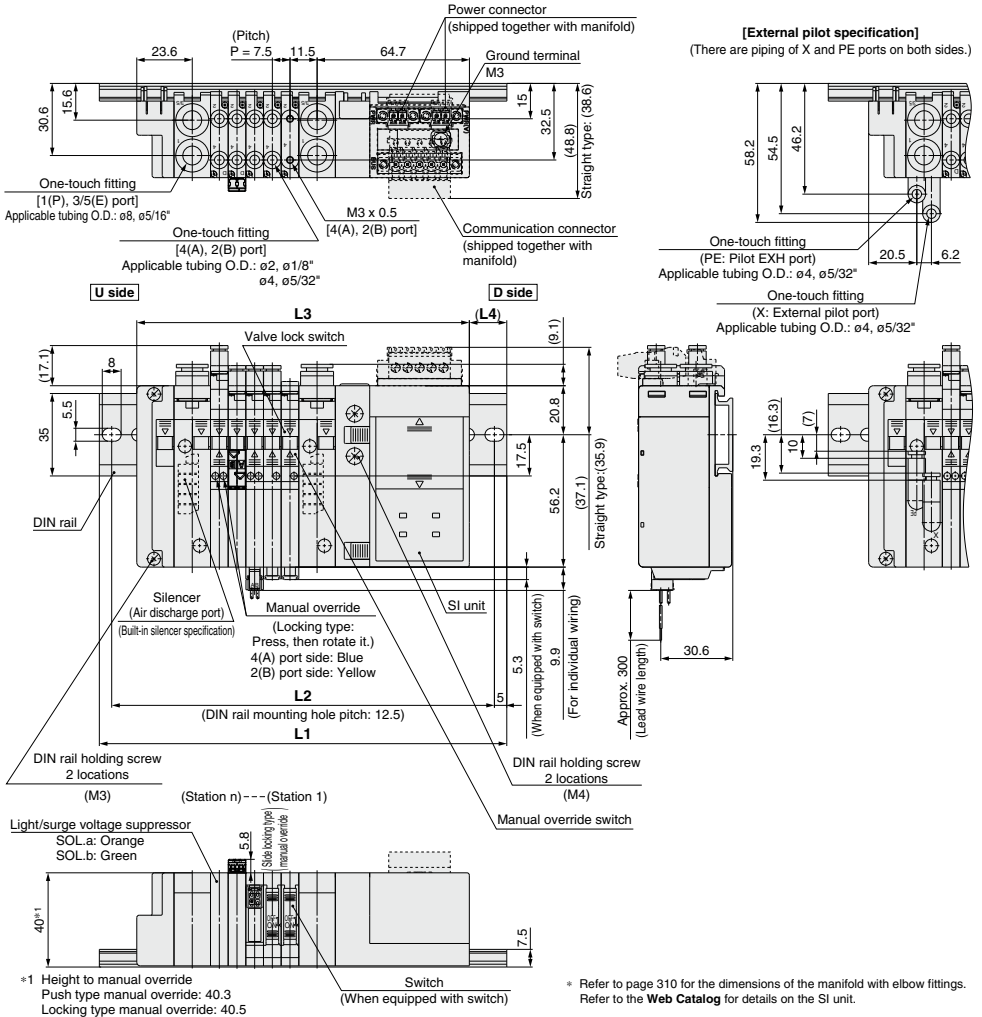

L: Dimensions

L	n	1	2	3	4	5	6	7	8	9	10	11	12	13	14	15	16	n: Stations	
L1	n	135.5	148	160.5	160.5	173	173	185.5	198	198	210.5	210.5	223	235.5	235.5	248	248		
L2	n	125	137.5	150	150	162.5	162.5	175	187.5	187.5	200	200	212.5	225	225	237.5	237.5		
L3	n	111.2	118.7	126.2	133.7	141.2	148.7	156.2	163.7	171.2	178.7	186.2	193.7	201.2	208.7	216.2	223.7		
L4	n	12	14.5	17	13.5	16	12	14.5	17	13.5	16	12	14.5	17	13.5	16	12		
L	n	17	18	19	20	21	22	23	24	25	26	27	28	29	30	31	32		
L1	n	260.5	273	273	285.5	285.5	298	310.5	310.5	323	323	335.5	348	348	360.5	360.5	373		
L2	n	250	262.5	262.5	275	275	287.5	300	300	312.5	312.5	325	337.5	337.5	350	350	362.5		
L3	n	231.2	238.7	246.2	253.7	261.2	268.7	276.2	283.7	291.2	298.7	306.2	313.7	321.2	328.7	336.2	343.7		
L4	n	14.5	17	13.5	16	12	14.5	17	13.5	16	12	14.5	17	13.5	16	12	14.5		

SJ1000/2000/3000 Series

Dimensions: SJ3000 Series for EX180 Integrated Type (For Output) Serial Transmission System

SS5J3-60S □ □ -Stations U(S, R, RS)

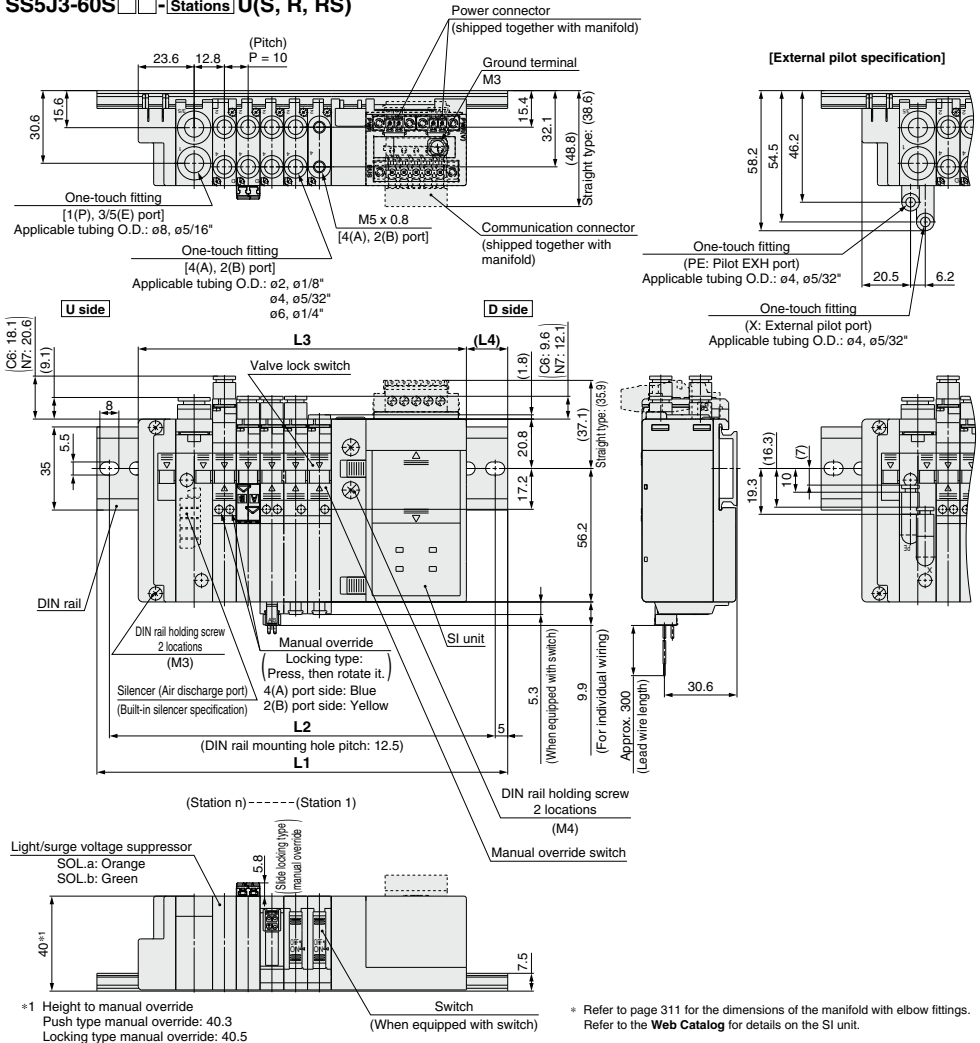

L: Dimensions

n: Stations

L	n	1	2	3	4	5	6	7	8	9	10	11	12	13	14	15	16
L1		123	135.5	148	160.5	173	173	185.5	198	210.5	223	235.5	235.5	248	260.5	273	285.5
L2		112.5	125	137.5	150	162.5	162.5	175	187.5	200	212.5	225	225	237.5	250	262.5	275
L3		98.2	108.2	118.2	128.2	138.2	148.2	158.2	168.2	178.2	188.2	198.2	208.2	218.2	228.2	238.2	248.2
L4		12.5	13.5	14.5	16	17	12	13	14	15.5	16.5	17.5	12.5	13.5	15	16	17
L	n	17	18	19	20	21	22	23	24	25	26	27	28	29	30	31	32
L1		285.5	298	310.5	323	335.5	348	348	360.5	373	385.5	398	398	410.5	423	435.5	448
L2		275	287.5	300	312.5	325	337.5	337.5	350	362.5	375	387.5	387.5	400	412.5	425	437.5
L3		258.2	268.2	278.2	288.2	298.2	308.2	318.2	328.2	338.2	348.2	358.2	368.2	378.2	388.2	398.2	408.2
L4		12	13	14.5	15.5	16.5	17.5	12.5	14	15	16	17	12	13.5	14.5	15.5	16.5

SJ1000/2000/3000 Series

Dimensions: SJ1000/2000/3000 Mixed Manifold

SS5J3-M60S □ □ - [Stations] U(S, R, RS)

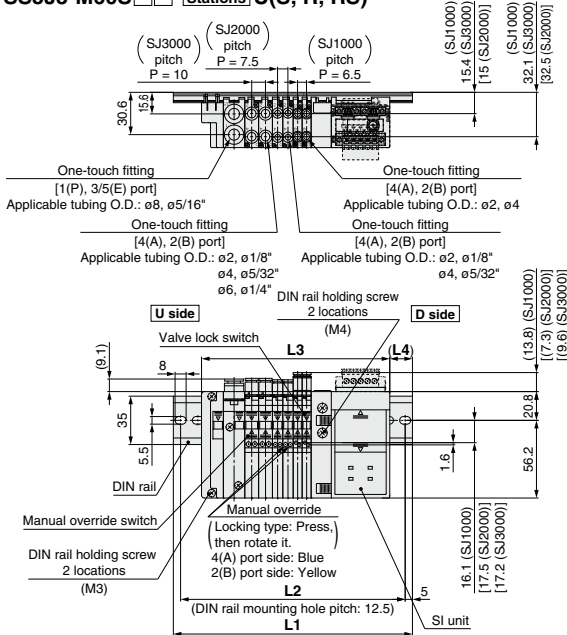

L dimension: Formula, L1 to L4
 $L3 = 6.5 \times n1 + 7.5 \times n2 + 10 \times n3 + 88.2$
 $M = (L3 + 4) / 12.5 + 1$
 Decimal fractions are truncated.
 $L1 = M \times 12.5 + 23$
 $L2 = L1 - 10.5$
 $L4 = (L1 - L3) / 2 - 2$

n1 = Number of SJ1000
 n2 = Number of SJ2000
 n3 = Number of SJ3000

* The dimensions of L1 to L4 for SS5J3-M60S □ □ - [Stations] D are the same as those of SS5J3-M60S □ □ - [Stations] U.

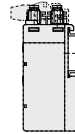

SS5J3-M60S □ □ - [Stations] B(S, R, RS)

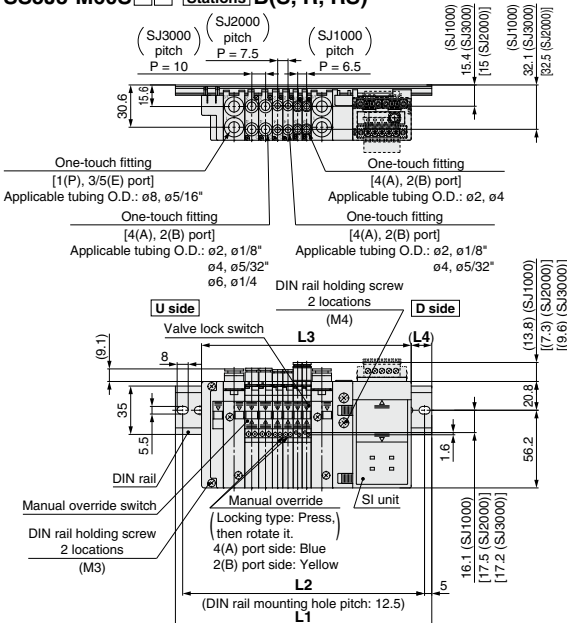

L dimension: Formula, L1 to L4
 $L3 = 6.5 \times n1 + 7.5 \times n2 + 10 \times n3 + 103.7$
 $M = (L3 + 4) / 12.5 + 1$
 Decimal fractions are truncated.
 $L1 = M \times 12.5 + 23$
 $L2 = L1 - 10.5$
 $L4 = (L1 - L3) / 2 - 2$

n1 = Number of SJ1000
 n2 = Number of SJ2000
 n3 = Number of SJ3000

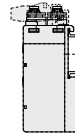

Plug-in Connector Type EX510 Gateway Type Serial Transmission System



Type **60S6B**

SJ1000/2000/3000 Series

An order cannot be placed with only the manifold part no. Be sure to order solenoid valves for mounting at the same time while referring to the ordering example.

How to Order Manifolds

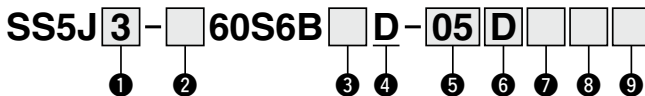

1 Manifold series

1	SJ1000
2	SJ2000
3	SJ3000 (SJ1000/2000/3000 mixed*1)

*1 Select "3" for the combination of SJ1000 and SJ2000 valves.

2 Mixed mounting type

Nil	Standard*1
M	Mixed mounting*2

*1 For SJ1000, 2000, and 3000 series valves, select "Nil" when only using a single series.
*2 Select "M" when SJ1000, SJ2000, or SJ3000 series valves will be mounted on the same manifold base together.

3 SI unit common

specification	
Nil	Positive common
N	Negative common

4 Unit mounting position

position	
D	D side

5 Valve stations

Symbol	Stations	Note
01	1 station	Up to 16 solenoids can be selected.
:	:	
16	16 stations	

* This number also includes the blanking block assembly. Since single and double wiring are available for the blanking block assembly, select a model compatible with the valve wiring specification to be used.

6 SUP/EXH block mounting position

U	U side
D	D side
B	Both sides
M*1	Special specifications

*1 Specify the required specifications (including port sizes other than ø8) on the manifold specification sheet.

7 Pilot type

Nil	Internal pilot
S	Internal pilot, Built-in silencer
R	External pilot
RS	External pilot, Built-in silencer

* There is no need to enter anything when the SUP/EXH block mounting position "M" is selected.
* The 3/5(E) port is plugged for the built-in silencer type.

8 SUP/EXH block fitting specification

Nil	L	B
Straight fitting With external pilot spec. X, PE port: Elbow fitting	Elbow fitting (Upward) With external pilot spec. X, PE port: Straight fitting	Elbow fitting (Downward) With external pilot spec. X, PE port: Elbow fitting

* There is no need to enter anything when the SUP/EXH block mounting position "M" is selected.

9 DIN rail length specified

Nil	Standard length
2	2 stations
:	:
16	16 stations

* Specify the number of valve stations without exceeding the max. number of stations.

SI Unit Part Nos.

Symbol	SI unit specification	SI unit part no.
Nil	NPN output (Positive common)	EX510-S002C
N	PNP output (Negative common)	EX510-S102C

For details on the EX510 Gateway Type Serial Transmission System, refer to the **Web Catalog** and the **Operation Manual**. Please download the **Operation Web Manual** via the SMC website: <https://www.smcworld.com>

How to Order Manifold Assembly

Ordering example (SS5J3-60S6B-□)

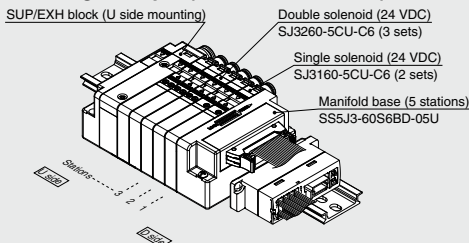

SS5J3-60S6BD-05U 1 set (Type 60S6B, 5-station manifold base part no.)

- * SJ3160-5CU-C6 2 sets (Single solenoid part no.)
- * SJ3260-5CU-C6 3 sets (Double solenoid part no.)

The asterisk denotes the symbol for the assembly. Prefix it to the part numbers of the solenoid valve, etc.

- For the valve arrangement, the valve closest to the D side is considered the 1st station.
- Under the manifold part number, state the valves to be mounted in order starting with the 1st station as shown in the figure. If the arrangement becomes too complicated, specify the details on a manifold specification sheet.
- When ordering a manifold, specify the part nos. of the valves to be mounted on it. (An order cannot be placed with only the manifold part no.)

How to Order Solenoid Valves

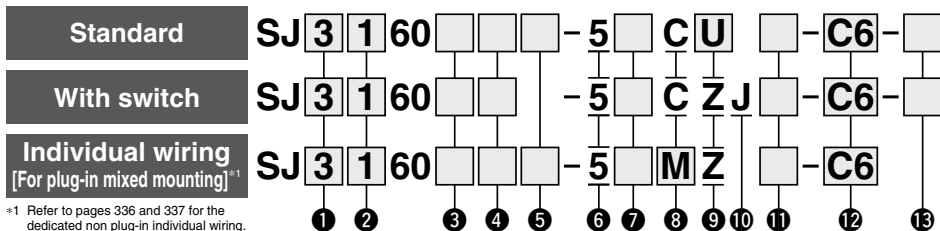

1 Series

1	SJ1000
2	SJ2000
3	SJ3000

2 Type of actuation

1	2-position single solenoid
2	2-position double solenoid
3	3-position closed center
4	3-position exhaust center
5	3-position pressure center
A	Dual 3-port valve: N.C./N.C.
B	Dual 3-port valve: N.O./N.O.
C	Dual 3-port valve: N.C./N.O.

* Refer to pages 281 to 284 for the symbol.

3 Pilot type

Nil	Internal pilot
R	External pilot

* External pilot specification is not applicable for 4-position dual 3-port valves.

4 Back pressure check valve

Nil	None
K	Built-in

* Back pressure check valve is not applicable for 3-position valve.

5 Coil type

Symbol	Coil type	SJ1000	SJ2000	SJ3000
Nil	Standard	—	●	●
T	With power-saving circuit (Continuous duty type)	●	●	●

* Be sure to select the power-saving circuit type if the valve is to be continuously energized for long periods of time.
* For the SJ1000 series, only the power-saving circuit type is available.

6 Rated voltage

5	24 VDC
---	--------

7 Common specification

Nil	Positive common
N	Negative common

* For the non-polar type, there is no need to select a symbol.
* When the standard valve and valve with a switch are used, select a common specification that matches the SJ unit common specification.

8 Connector entry

Symbol	C: Dedicated for centralized wiring	M: Individual wiring. With lead wire Length 300 mm	MN: Individual wiring. Without lead wire	MO: Individual wiring. Without connector
SJ1000	●	—	—	—
SJ2000	●	●	●	—
SJ3000	●	●	●	●

* Connector entries with the symbol "M□" cannot use the switch signal from the common wiring on the manifold. For details, refer to the "Connector Wiring Diagram" on page 280.
* When ordering a connector assembly separately, refer to pages 363 and 364.

11 Manual override

Symbol/Specification	SJ1000	SJ2000	SJ3000
Nil: Non-locking push type 	●	●	●
D: Push-turn locking slotted type 	●	●	●
F: Slide locking type 	—	●	●

12 A, B port size

Metric/One-touch fitting					
Symbol	A, B port	SJ1000	SJ2000	SJ3000	
C2	ø2	●	●	●	
C4	ø4	●	●	●	
C6	ø6	—	—	●	
L2	ø2	—	●	●	
L4	ø4	—	●	●	
L6	ø6	—	—	●	
B2	ø2	—	●	●	
B4	ø4	—	●	●	
B6	ø6	—	—	●	
Thread piping					
Symbol	A, B port	SJ1000	SJ2000	SJ3000	
M3	M3 x 0.5	—	●	—	
M5	M5 x 0.8	—	—	●	

9 Light/surge voltage suppressor

Symbol	Specification	SJ1000	SJ2000	SJ3000
U	With light/surge voltage suppressor (Non-polar type)	—	●	●
Z	With light/surge voltage suppressor (Polar type)	●	●	●

* When the types with power-saving circuit, with switches, and individual wiring are used, the non-polar type cannot be selected.
* Select "CU" or "CZ" for the valve when the SJ unit output polarity is Nil (positive common). Select "CU" or "NCZ" for the valve when the SJ unit output polarity is N (negative common).

10 With switch

	SJ1000	SJ2000	SJ3000
	—	●	●

Inch/One-touch fitting

Symbol	A, B port	SJ1000	SJ2000	SJ3000	
N1	ø1/8"	—	●	●	
N3	ø5/32"	—	●	●	
N7	ø1/4"	—	—	●	
LN1	ø1/8"	—	●	●	
LN3	ø5/32"	—	●	●	
LN7	ø1/4"	—	—	●	
BN1	ø1/8"	—	●	●	
BN3	ø5/32"	—	●	●	
BN7	ø1/4"	—	—	●	

13 Single solenoid wiring specification

Nil	Single wiring
D	Double wiring

* There is no need to enter anything for 2-position double, 3-position, and 4-position solenoid valves. Select this when the unused numbers to wiring are set. Refer to page 280 for details.

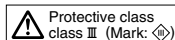

SJ1000/2000/3000 Series

Dimensions: SJ1000 Series for EX510 Gateway Type Serial Transmission System

SS5J1-60S6B□D-StationsU(S, R, RS)

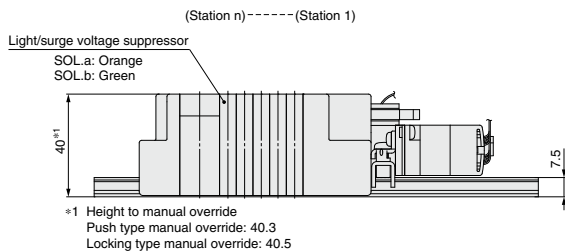
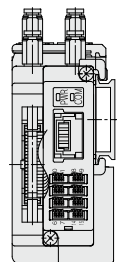
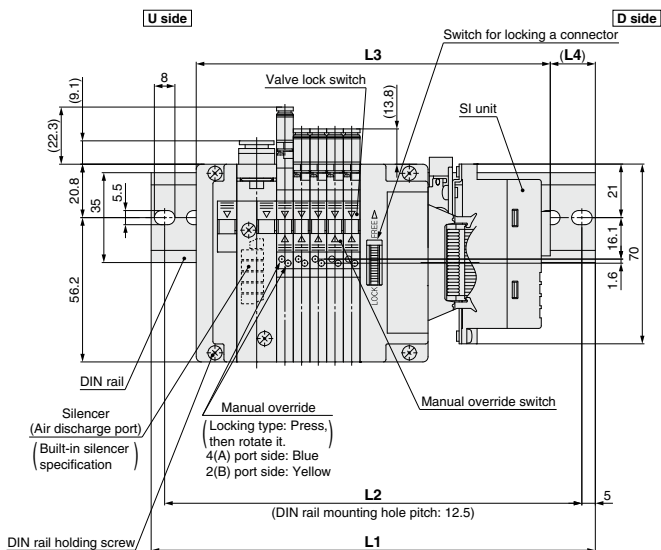
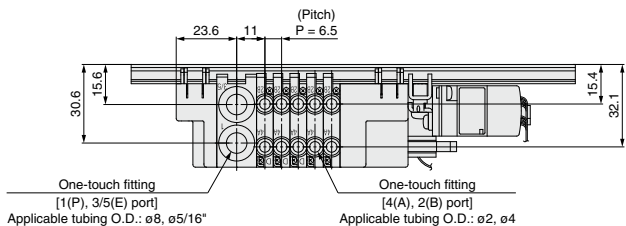

L: Dimensions

n: Stations

L	n	1	2	3	4	5	6	7	8	9	10	11	12	13	14	15	16
L1		135.5	148	148	160.5	173	173	185.5	185.5	198	198	210.5	210.5	223	223	235.5	235.5
L2		125	137.5	137.5	150	162.5	162.5	175	175	187.5	187.5	200	200	212.5	212.5	225	225
L3		111.9	118.4	124.9	131.4	137.9	144.4	150.9	157.4	163.9	170.4	176.9	183.4	189.9	196.4	202.9	209.4
L4		12	15	11.5	14.5	17.5	14.5	17.5	14	17	14	17	13.5	16.5	13.5	16.5	13

Dimensions: SJ1000 Series for EX510 Gateway Type Serial Transmission System

SS5J1-60S6B□D- Stations B(S, R, RS)

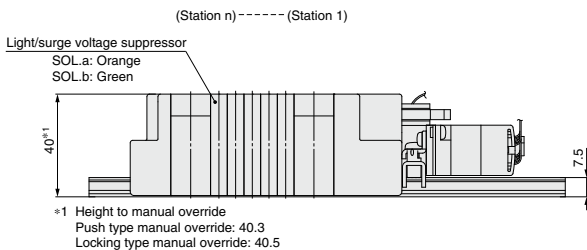
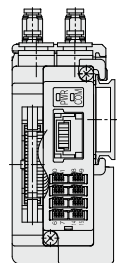
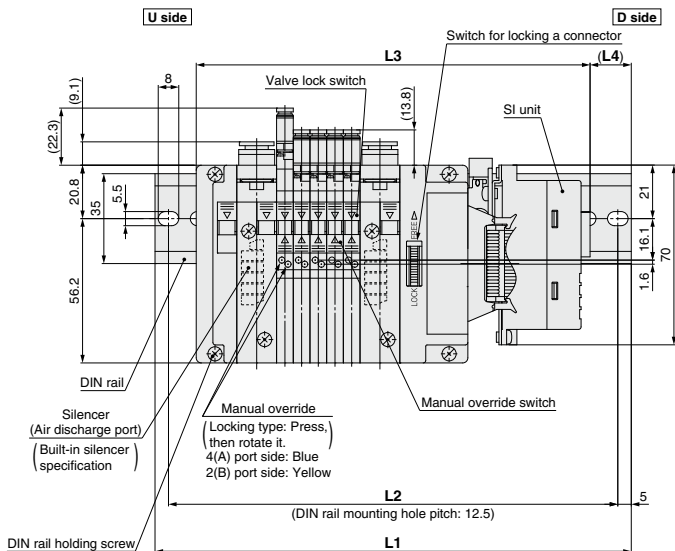
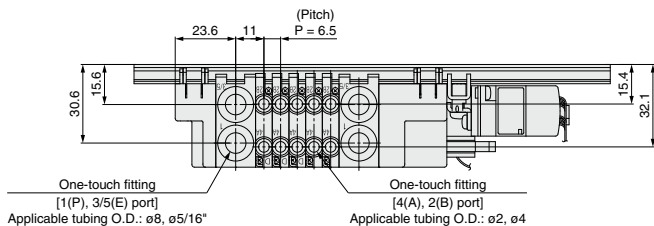

L: Dimensions

n: Stations

L \ n	1	2	3	4	5	6	7	8	9	10	11	12	13	14	15	16
L1	160.5	160.5	173	173	185.5	185.5	198	198	210.5	210.5	223	223	235.5	235.5	248	248
L2	150	150	162.5	162.5	175	175	187.5	187.5	200	200	212.5	212.5	225	225	237.5	237.5
L3	127.4	133.9	140.4	146.9	153.4	159.9	166.4	172.9	179.4	185.9	192.4	198.9	205.4	211.9	218.4	224.9
L4	16.5	13.5	16.5	13	16	13	16	12.5	15.5	12.5	15.5	12	15	12	15	11.5

SJ1000/2000/3000 Series

Dimensions: SJ2000 Series for EX510 Gateway Type Serial Transmission System

SS5J2-60S6B □ D - Stations □ U - □

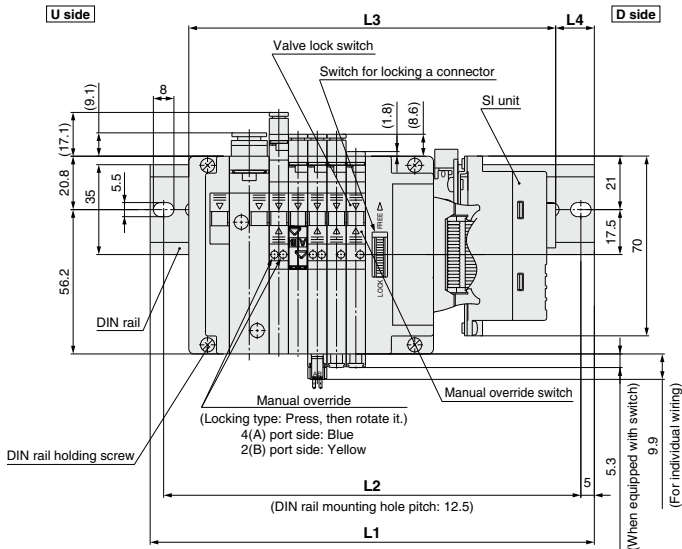
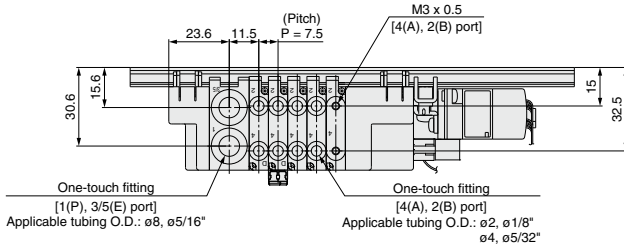

(Station n) ----- (Station 1)

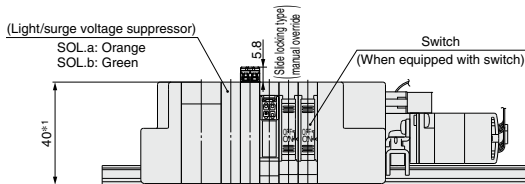

*1 Height to manual override
 Push type manual override: 40.3
 Locking type manual override: 40.5

* Refer to page 316 for the external pilot specifications and page 310 for the dimensions of the manifold with elbow fittings.
 Refer to the **Web Catalog** for details on the SI unit.

L: Dimensions

L	n	1	2	3	4	5	6	7	8	9	10	11	12	13	14	15	16
L1		148	148	160.5	160.5	173	185.5	185.5	198	198	210.5	223	223	235.5	248	248	260.5
L2		137.5	137.5	150	150	162.5	175	175	187.5	187.5	200	212.5	212.5	225	237.5	237.5	250
L3		112.9	120.4	127.9	135.4	142.9	150.4	157.9	165.4	172.9	180.4	187.9	195.4	202.9	210.4	217.9	225.4
L4		17.5	14	16.5	12.5	15	17.5	14	16.5	12.5	15	17.5	14	16.5	19	15	17.5

n: Stations

Dimensions: SJ2000 Series for EX510 Gateway Type Serial Transmission System

SS5J2-60S6B □ D- [Stations] B- □

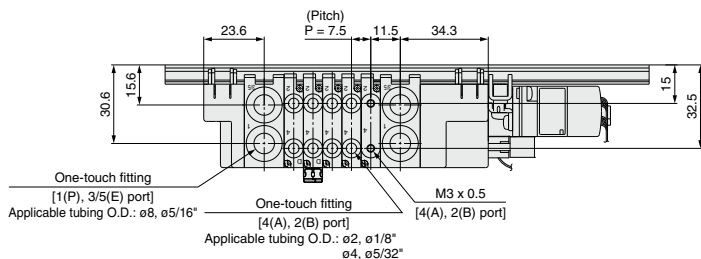

U side

D side

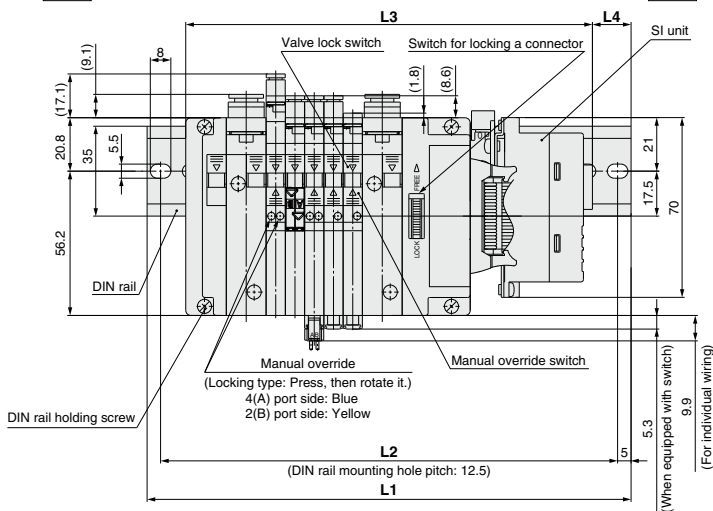

(Station n)----- (Station 1)

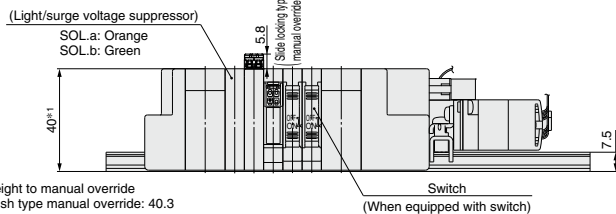

*1 Height to manual override
 Push type manual override: 40.3
 Locking type manual override: 40.5

* Refer to page 317 for the external pilot specifications and page 310 for the dimensions of the manifold with elbow fittings.
 Refer to the **Web Catalog** for details on the SI unit.

L: Dimensions

n: Stations

L	n	1	2	3	4	5	6	7	8	9	10	11	12	13	14	15	16
L1		160.5	160.5	173	185.5	185.5	198	198	210.5	223	223	235.5	248	248	260.5	260.5	273
L2		150	150	162.5	175	175	187.5	187.5	200	212.5	212.5	225	237.5	237.5	250	250	262.5
L3		128.4	135.9	143.4	150.9	158.4	165.9	173.4	180.9	188.4	195.9	203.4	210.9	218.4	225.9	233.4	240.9
L4		16	12.5	15	17.5	13.5	16	12.5	15	17.5	13.5	16	18.5	15	17.5	13.5	16

SJ1000/2000/3000 Series

Dimensions: SJ3000 Series for EX510 Gateway Type Serial Transmission System

SS5J3-60S6B □ D- Stations U- □

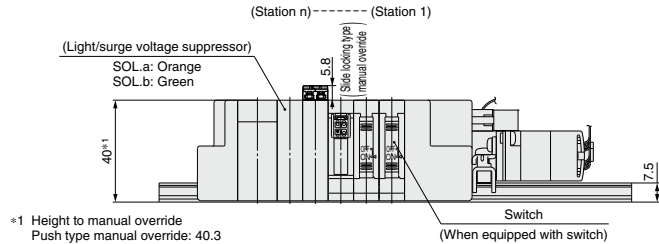
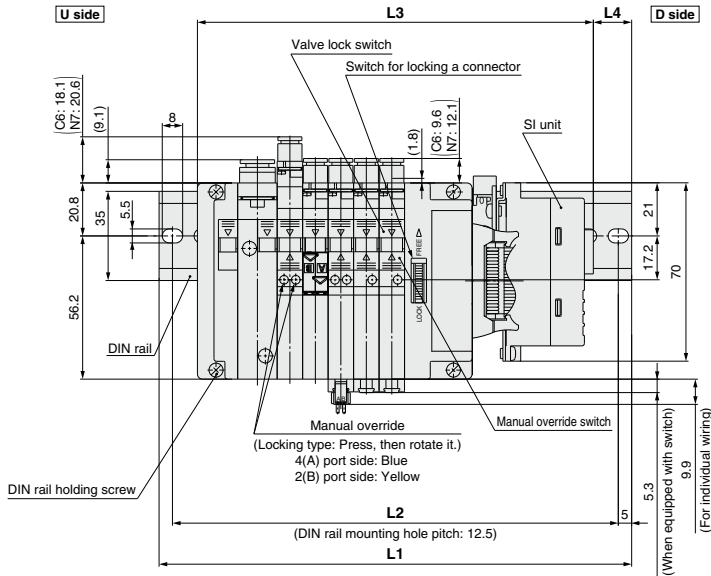
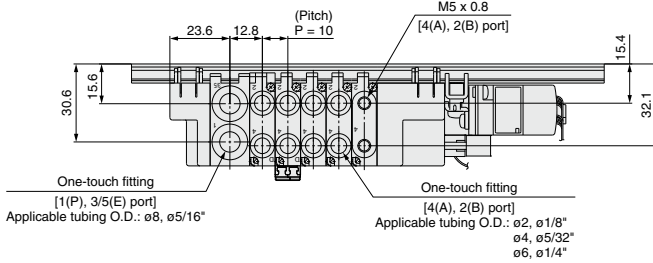

* Refer to page 318 for the external pilot specifications and page 311 for the dimensions of the manifold with elbow fittings. Refer to the **Web Catalog** for details on the SI unit.

L: Dimensions

L	n	1	2	3	4	5	6	7	8	9	10	11	12	13	14	15	16
L1		148	160.5	160.5	173	185.5	198	210.5	210.5	223	235.5	248	260.5	273	273	285.5	298
L2		137.5	150	150	162.5	175	187.5	200	200	212.5	225	237.5	250	262.5	262.5	275	287.5
L3		115.4	125.4	135.4	145.4	155.4	165.4	175.4	185.4	195.4	205.4	215.4	225.4	235.4	245.4	255.4	265.4
L4		16.5	17.5	12.5	14	15	16.5	17.5	12.5	14	15	16.5	17.5	19	14	15	16.5

n: Stations

Dimensions: SJ3000 Series for EX510 Gateway Type Serial Transmission System

SS5J3-60S6B □ **D-** Stations **B-** □

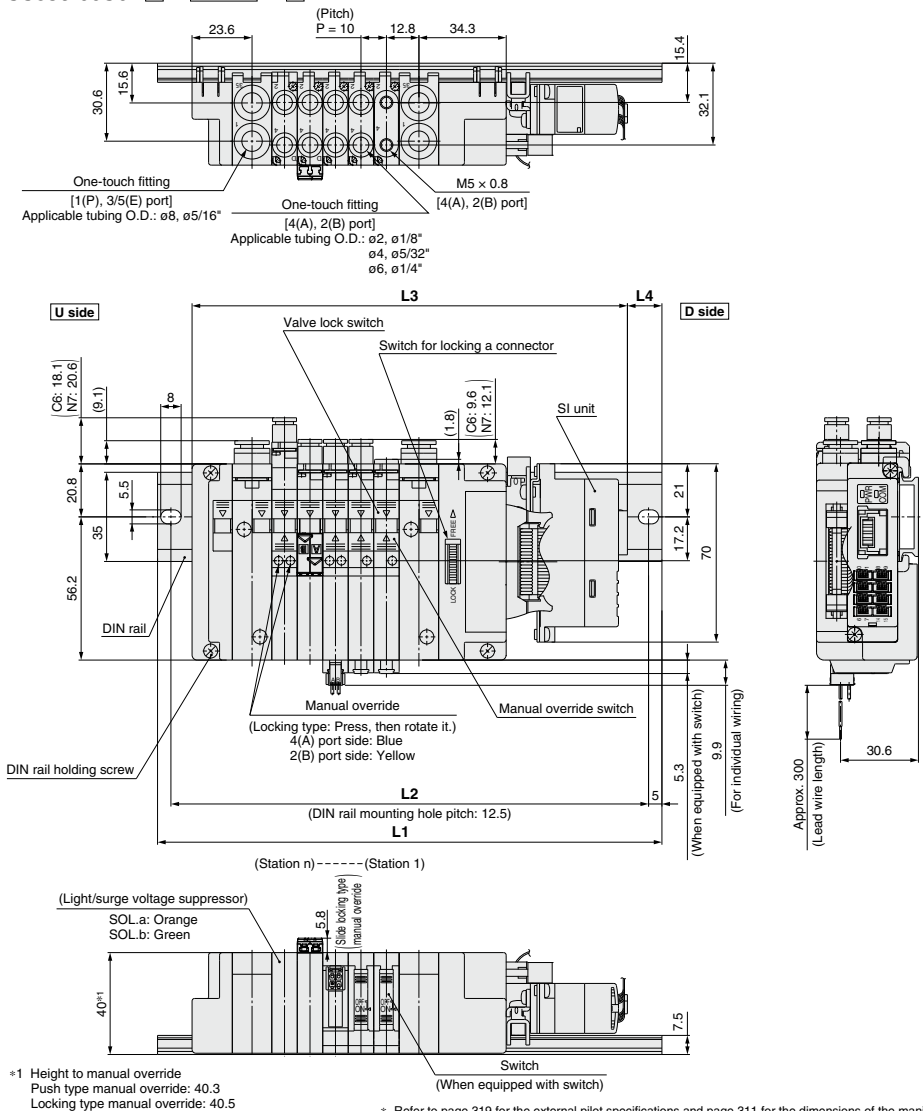

* Refer to page 319 for the external pilot specifications and page 311 for the dimensions of the manifold with elbow fittings.
 Refer to the **Web Catalog** for details on the SI unit.

L: Dimensions

n: Stations

L	n	1	2	3	4	5	6	7	8	9	10	11	12	13	14	15	16
L1		160.5	173	185.5	185.5	198	210.5	223	235.5	248	248	260.5	273	285.5	298	298	310.5
L2		150	162.5	175	175	187.5	200	212.5	225	237.5	237.5	250	262.5	275	287.5	287.5	300
L3		130.9	140.9	150.9	160.9	170.9	180.9	190.9	200.9	210.9	220.9	230.9	240.9	250.9	260.9	260.9	280.9
L4		15	16	17.5	12.5	13.5	15	16	17.5	18.5	13.5	15	16	17.5	18.5	13.5	15

SJ1000/2000/3000 Series

Dimensions: SJ1000/2000/3000 Mixed Manifold for EX510 Gateway Type Serial Transmission System

SS5J3-M60S6B □D- [Stations] U- □

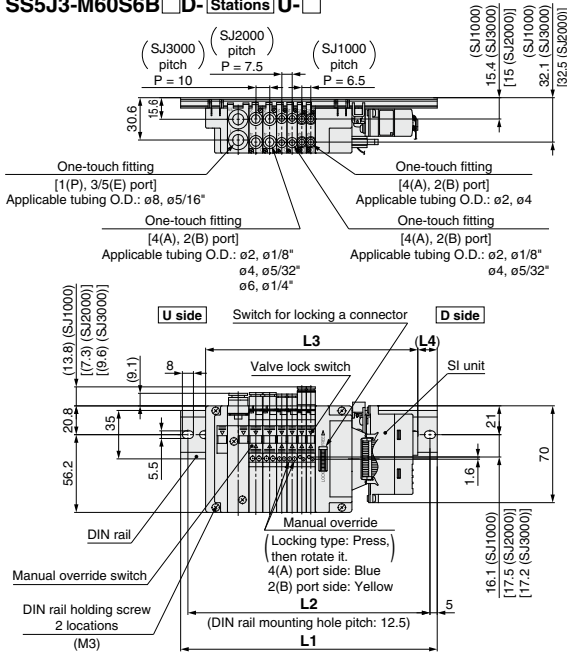

L dimension: Formula, L1 to L4
 $L3 = 6.5 \times n1 + 7.5 \times n2 + 10 \times n3 + 105.4$
 $M = (L3 + 4) / 12.5 + 1$
 Decimal fractions are truncated.
 $L1 = M \times 12.5 + 23$
 $L2 = L1 - 10.5$
 $L4 = (L1 - L3) / 2 - 2$

n1 = Number of SJ1000
 n2 = Number of SJ2000
 n3 = Number of SJ3000

* The dimensions of L1 to L4 for SS5J3-M60S6B □D- [Stations] D are the same as those of SS5J3-M60S6B □D- [Stations] U.

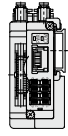

SS5J3-M60S6B □D- [Stations] B- □

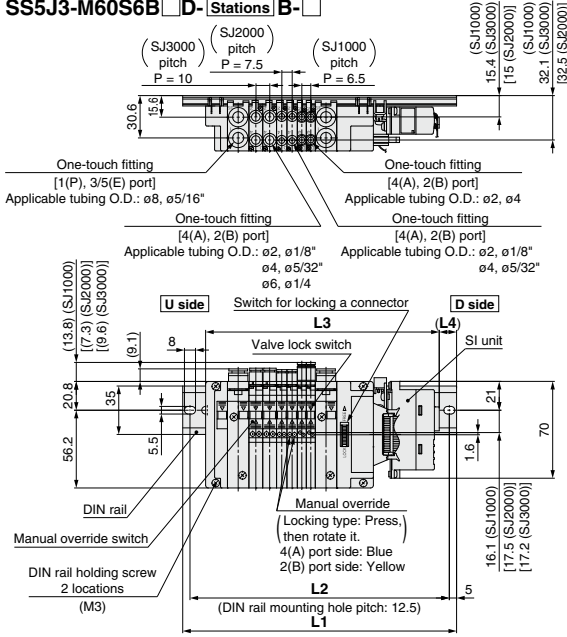

L dimension: Formula, L1 to L4
 $L3 = 6.5 \times n1 + 7.5 \times n2 + 10 \times n3 + 120.9$
 $M = (L3 + 4) / 12.5 + 1$
 Decimal fractions are truncated.
 $L1 = M \times 12.5 + 23$
 $L2 = L1 - 10.5$
 $L4 = (L1 - L3) / 2 - 2$

n1 = Number of SJ1000
 n2 = Number of SJ2000
 n3 = Number of SJ3000

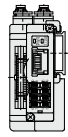

SJ1000/2000/3000 Series Manifold Exploded View

Connector Type

Type 60F, 60P, and 60S manifolds

Type 60S (Plug-in, EX180 Integrated type (for output) serial transmission system) manifold

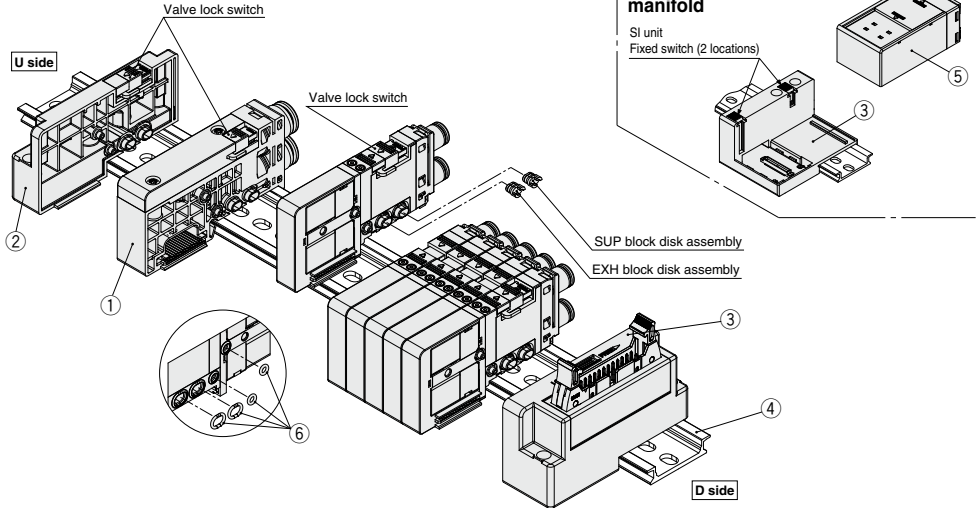

Component Parts: Plug-in (Connector Type)

No.	Description	Part no.	Note
1	Internal pilot	SJ3000-50-1A-□□	(Metric size) C6: With ø6 One-touch fitting (straight) C8: With ø8 One-touch fitting (straight) L6: With ø6 One-touch fitting (elbow upward entry) L8: With ø8 One-touch fitting (elbow upward entry) B6: With ø6 One-touch fitting (elbow downward entry) B8: With ø8 One-touch fitting (elbow downward entry)
	Internal pilot, Built-in silencer	SJ3000-50-1AS-□□	
	External pilot	SJ3000-50-1AR-□□ (X, PE port: Metric size ø4 Inch size ø5/32")	
	External pilot, Built-in silencer	SJ3000-50-1ARS-□□ (X port: Metric size ø4 Inch size ø5/32")	
	For different pressures, Internal pilot* ¹	SJ3000-50-3A-□□	
2	For different pressures, Internal pilot, Built-in silencer* ¹	SJ3000-50-3AS-□□	(Inch size) N7: With 1/4" One-touch fitting (straight) N9: With 5/16" One-touch fitting (straight)
	End block assembly	SJ3000-53-1A	For the U side
3	Connector block assembly	SJ3000-42-□A-□	Refer to the connector block assembly part nos. shown below.
4	DIN rail	VZ1000-11-1-□	Refer to page 346.
5	SI unit	EX180-□□	Refer to the SI unit part nos. on page 312.
6	O-ring for valve connection* ²	SJ3000-96-1A	The part no. shown on the left includes parts for 5 units. (10 pcs. each for the P and E ports and for the X and PE ports)

*¹ As the valves cannot be operated only with the SUP/EXH block assembly for different pressures, select them in combination with the SUP/EXH block assembly for internal/external pilot.

*² Included with valves, SUP/EXH block assemblies, and connector block assemblies

* Refer to page 344 for the SUP/EXH block disk assembly and method of handling parts at different pressures.

Connector Block Assembly Part Nos.

Connector specifications	Mounting position	Part no.	Note
For D-sub connector (Locking bracket: Metric size thread)	D side	SJ3000-42-1A-□	□: 1 (Connector upward) □: 2 (Connector lateral)
For D-sub connector (Locking bracket: Unified thread)		SJ3000-42-1AU-□	
For flat ribbon cable 26 pins		SJ3000-42-2A-□	
For flat ribbon cable 20 pins		SJ3000-42-3A-□	
For flat ribbon cable 10 pins		SJ3000-42-4A-□	
For EX180 serial wiring* ¹		SJ3000-42-20A	
For EX510 serial wiring* ¹		SJ3000-42-3A-2	

*¹ An SI unit is not included.

Connector Block Assembly with SI Unit

Connector block assembly with EX180 serial wiring	D side	SJ3000-42-20A-□□	For details on the □□ portion, refer to the SI unit part nos. on page 312. Example: SJ3000-42-20A-V2 (CC-Link compliant, T-branch type)
---	--------	------------------	---

SJ1000/2000/3000 Series

Cable Type

Type 60LF and 60LP manifolds

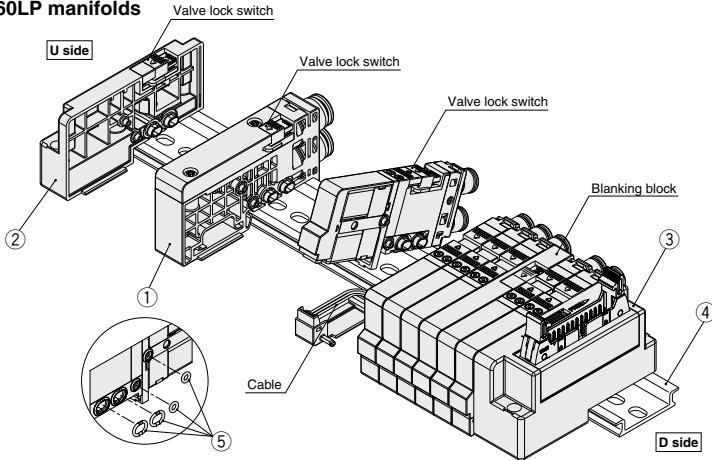

Component Parts: Plug-in (Cable Type)

No.	Description	Part no.	Note
1	Internal pilot	SJ3000-50-5A-□□	(Metric size)
	Internal pilot, Built-in silencer	SJ3000-50-5AS-□□	C6: With ø6 One-touch fitting (straight)
	External pilot	SJ3000-50-5AR-□□	C8: With ø8 One-touch fitting (straight)
		(X, PE port: Metric size ø4 Inch size ø5/32 ¹)	L6: With ø6 One-touch fitting (elbow upward entry) L8: With ø8 One-touch fitting (elbow upward entry)
	External pilot, Built-in silencer	SJ3000-50-5ARS-□□	B6: With ø6 One-touch fitting (elbow downward entry) B8: With ø8 One-touch fitting (elbow downward entry)
		(X port: Metric size ø4 Inch size ø5/32 ¹)	(Inch size) N7: With 1/4" One-touch fitting (straight) N9: With 5/16" One-touch fitting (straight)
2	End block assembly	SJ3000-53-1A	For the U side
3	Connector block assembly	SJ3000-42-□□A-□	Refer to the connector block assembly part nos. shown below.
4	DIN rail	VZ1000-11-1-□	Refer to page 346.
5	O-ring for valve connection ^{*2}	SJ3000-96-1A	The part no. shown on the left includes parts for 5 units. (10 pcs. each for the P and E ports and for the X and PE ports)

^{*1} As the valves cannot be operated only with the SUP/EXH block assembly for different pressures, select them in combination with the SUP/EXH block assembly for internal/external pilot.

^{*2} Included with valves, SUP/EXH block assemblies, and connector block assemblies

^{*} Refer to page 344 for the SUP/EXH block disk assembly and method of handling parts at different pressures.

●Connector Block Assembly

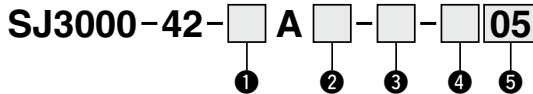

1 Connector type

7	For D-sub connector	SJ3000 series
8	For flat ribbon cable 26 pins	
9	For flat ribbon cable 20 pins	
10	For flat ribbon cable 10 pins	
11	For D-sub connector	SJ2000 series
12	For flat ribbon cable 26 pins	
13	For flat ribbon cable 20 pins	
14	For flat ribbon cable 10 pins	

^{*} All connector block assembly mounting positions are on the D side.

^{*} The connector block assembly includes the cables necessary for the number of stations.

2 Locking bracket

NII	Metric size thread
U	Unified thread

^{*} D-sub connector only

3 Connector entry direction

1	Upward
2	Lateral

4 Wiring

NII	All double wiring
S	All single wiring

5 Valve stations

02 to 10	For D-sub connector	All double wiring
02 to 20		All single wiring
02 to 10	For flat ribbon cable 26 pins	All double wiring
02 to 20		All single wiring
02 to 09	For flat ribbon cable 20 pins	All double wiring
02 to 18		All single wiring
02 to 04	For flat ribbon cable 10 pins	All double wiring
02 to 08		All single wiring

How to Increase Manifold Stations

Connector Type

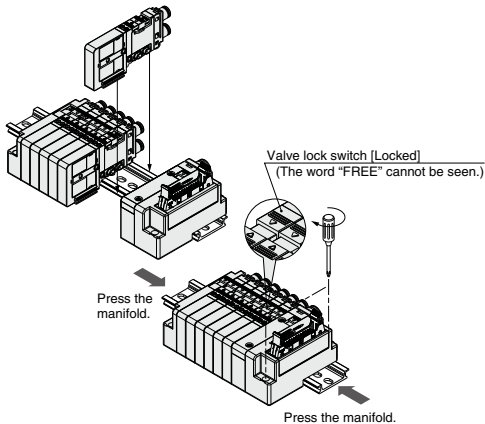
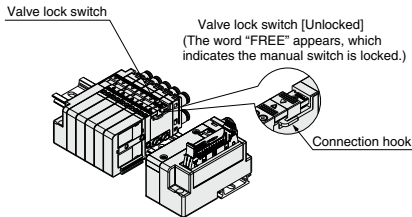
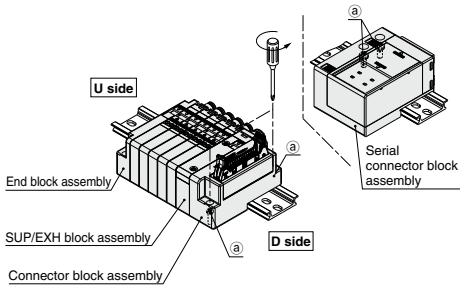

1 Loosen threads **a**, which are fixed onto the DIN rail (two locations on one side).

2 In the direction of the coil, slide the valve where the station is desired to add and the valve lock switch on each block.

If blocks are removed without completely releasing the valve lock switch, the connection hook of that switch could be damaged or deformed.

3 Install an additional valve or a SUP/EXH block assembly on the DIN rail.

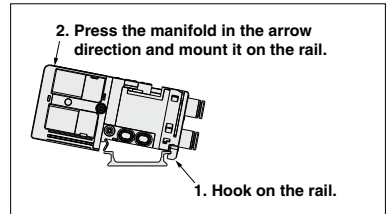

A manifold equipped with a valve or a block assembly can be mounted on the DIN rail. However, a serial connector block assembly cannot be mounted on the DIN rail when it is connected with another block; the serial connector block must be mounted separately.

4 Press the valves and block assemblies to each other for connection. Press the valve lock switch in the cylinder port direction until it does not go any further. Fasten threads **a** onto the DIN rail.

After fixing the connector block assembly, fasten the threads onto the end block assembly while holding it lightly by hand. This is necessary to improve sealing.

Caution (D-sub, Connector block assembly for flat ribbon cable, End block assembly M3: 0.6 N·m
Connector block assembly for EX180 serial wiring M4: 1.4 N·m
Mounting bracket for EX510 serial wiring M4: 0.6 N·m)

Caution

1. Be sure to turn off the power and stop the supply of air before disassembly. Furthermore, since air may remain inside the actuator, piping, and manifold, confirm that the air is completely exhausted before performing any work.
2. After assembly and disassembly, air leakage could occur if blocks are not well connected or a thread is not tightly fastened onto the end block assembly. Before supplying air, make sure that no gaps exist in between blocks and that the valve and block are tightly fastened onto the DIN rail. Also, make sure that air is not leaking before use.
3. For the SJ3A6 series manifold with vacuum release valve with restrictor, there is no valve lock switch for connecting, so when mounting, tighten the screws after checking that there are no gaps between valves.

SJ1000/2000/3000 Series

Cable Type

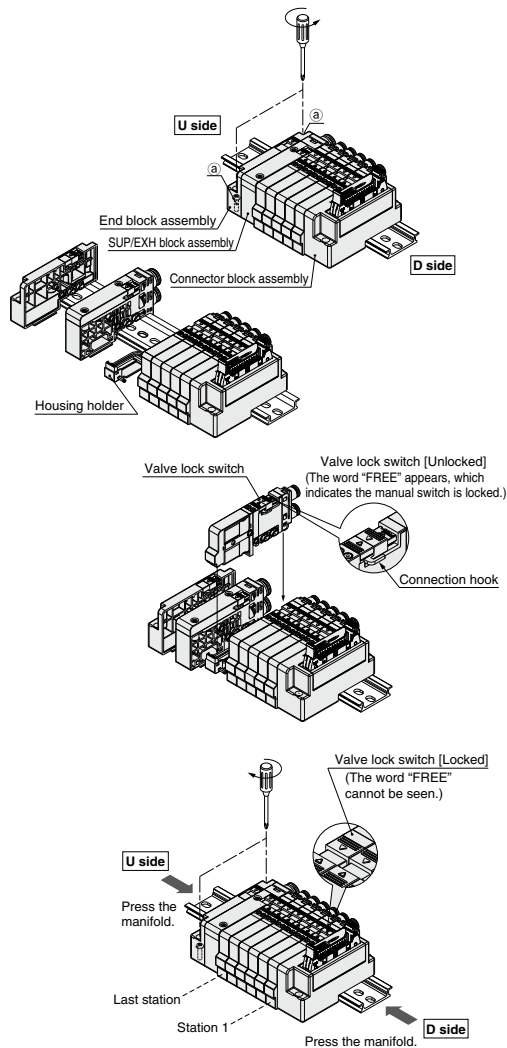

Caution

To increase a manifold station, a housing holder (refer to the table below) is required in addition to the solenoid valve.

For the manifold with less than the max. number of stations, spare housing (for one station) for adding the manifold station is stored in the housing holder of the last station or the SUP/EXH block assembly. To increase a manifold station, follow the steps below to disassemble and reassemble the manifold.

Series	Housing holder part no.	Material	Note
SJ2000	SJ2000-86-1	Resin	White
SJ3000	SJ3000-86-1		

1 Loosen threads ②, which are fixed onto the DIN rail (two locations).

[* To replace the DIN rail, also loosen the screws (2 locations) on the connector block assembly.]

2 Slide the valve lock switch on each block toward the coil, and then remove the end block assembly and SUP/EXH block assembly.

3 Take out the stored housing for adding the manifold station and assemble it to a newly added housing holder. Insert this housing holder next to the current housing holder.

How to mount the housing

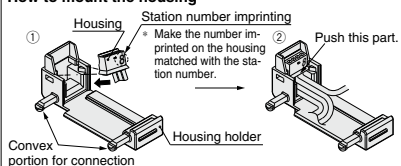

① Mount the housing in the arrow direction.
② Push in the housing securely using a flat blade screwdriver.

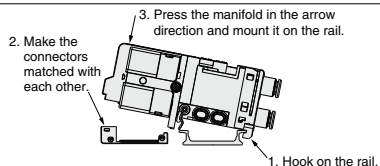

4 Press the valves and block assemblies to each other for connection. Press the valve lock switch in the cylinder part direction until it does not go any further. Fasten threads ② onto the DIN rail. Connect the added valve and SUP/EXH block, and then fasten the DIN rail fixing screws on the end block on the U side.

After fixing the connector block assembly, fasten the threads onto the end block assembly while holding it lightly by hand. This is necessary to improve sealing.

Caution D-sub, Connector block assembly for flat ribbon cable, End block assembly M3: 0.6 N-m

Caution

- When adding a valve and SUP/EXH block, add the valve to the U side of the last station, and then add the SUP/EXH block assembly to its U side. The SUP/EXH block cannot be added to a position adjacent to the connector block assembly or an intermediate position.
- Be sure to turn off the power and stop the supply of air before disassembly. Furthermore, since air may remain in the actuator, piping, and manifold, confirm that the air is completely exhausted before performing any work.
- After assembly and disassembly, air leakage could occur if blocks are not well connected or a thread is not tightly fastened onto the end block assembly. Before supplying air, make sure that no gaps exist in between blocks and that the valve and block are tightly fastened onto the DIN rail. Also, make sure that air is not leaking before use.
- For the SJ3A6 series manifold with vacuum release valve with restrictor, there is no valve lock switch for connecting, so when mounting, tighten the screws after checking that there are no gaps between valves.

**Non Plug-in
Individual Wiring Manifold**

SJ2000/3000 Series

p. 336 Individual Wiring

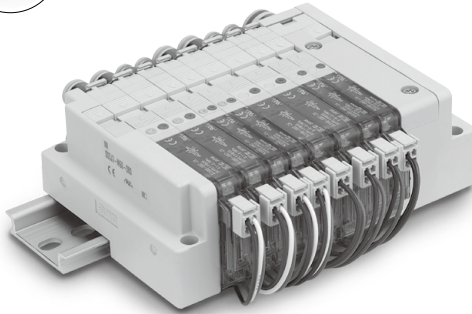

Non Plug-in Individual Wiring

RoHS

SJ2000/3000 Series

An order cannot be placed with only the manifold part no. Be sure to order solenoid valves for mounting at the same time while referring to the ordering example.

How to Order

Individual wiring manifold

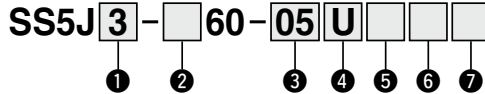

1 Series

2	SJ2000
3	SJ3000 (SJ2000/3000 mixed)

3 Valve stations

Symbol	Stations
01	1 station
:	:
20	20 stations

2 Mixed mounting type

Nil	Standard*1
M	Mixed mounting*2

*1 There is no need to enter anything when you operate either the SJ2000 or SJ3000 series alone.

*2 Select "M" when SJ2000 or SJ3000 series valves will be mounted on the same manifold base together.

4 SUP/EXH block mounting position

U	U side
D	D side
B	Both sides
M*1	Special specifications

*1 Specify the required specifications (including port sizes other than ø8) on the manifold specification sheet.

5 Pilot type

Nil	Internal pilot
S	Internal pilot, Built-in silencer
R	External pilot
RS	External pilot, Built-in silencer

* There is no need to enter anything when the SUP/EXH block mounting position "M" is selected.

* The 3/5(E) port is plugged for the built-in silencer type.

6 SUP/EXH block fitting specification

Nil	L	B
Straight fitting With external pilot spec. X, PE port: Elbow fitting	Elbow fitting (Upward) With external pilot spec. X, PE port: Straight fitting	Elbow fitting (Downward) With external pilot spec. X, PE port: Elbow fitting

* There is no need to enter anything when the SUP/EXH block mounting position "M" is selected.

7 DIN rail length specified

Nil	Standard length
2	2 stations
:	:
20	20 stations

* Specify the number of valve stations without exceeding the max. number of stations.

How to Order Manifold Assembly

Ordering example (SS5J3-60-□)

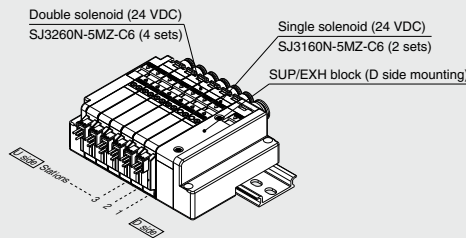

SS5J3-60-06D 1 set (Manifold part no.)

- * SJ3160N-5MZ-C6 2 sets (Single solenoid part no.)
 - * SJ3260N-5MZ-C6 4 sets (Double solenoid part no.)
- ↳ The asterisk denotes the symbol for the assembly.
Prefix it to the part numbers of the solenoid valve, etc.

· For the valve arrangement, the valve closest to the D side is considered the 1st station.

· Under the manifold part number, state the valves to be mounted in order starting with the 1st station as shown in the figure. If the arrangement becomes too complicated, specify the details on a manifold specification sheet.

How to Order Solenoid Valves

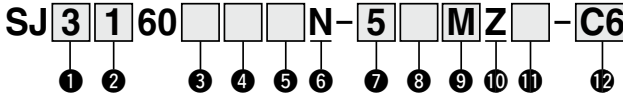

1 Series

2	SJ2000
3	SJ3000

2 Type of actuation

1	2-position single solenoid
2	2-position double solenoid
3	3-position closed center
4	3-position exhaust center
5	3-position pressure center
A	Dual 3-port valve: N.C./N.C.
B	Dual 3-port valve: N.O./N.O.
C	Dual 3-port valve: N.C./N.O.

* Refer to pages 281 to 288 for the symbol.

3 Pilot type

NII	Internal pilot
R	External pilot

* External pilot specification is not applicable for 4-position dual 3-port valves.

4 Back pressure check valve

NII	None
K	Built-in

* Back pressure check valve is not applicable for 3-position valve.

5 Coil type

NII	Standard
T	With power-saving circuit (Continuous duty type)

* Be sure to select the power-saving circuit type if the valve is to be continuously energized for long periods of time.

6 Non plug-in

7 Rated voltage

5	24 VDC
6	12 VDC

8 Common specification

NII	Positive common
N	Negative common

9 Connector entry

<p>M: Individual wiring. With lead wire Length 300 mm</p> <p>Without linkage-printed circuit board</p>	<p>MN: Individual wiring. Without lead wire (With connector, socket)</p> <p>Without linkage-printed circuit board</p>	<p>MO: Individual wiring. Without connector</p> <p>Without linkage-printed circuit board</p>
---	--	---

* When ordering a connector assembly separately, refer to pages 383 and 384.

11 Manual override

<p>NII: Non-locking push type</p>	<p>D: Push-turn locking slotted type</p>	<p>F: Slide locking type</p>
--	---	---

12 A, B port size

<p>Straight (Metric size) C2: ø2 One-touch fitting C4: ø4 One-touch fitting C6: ø6 One-touch fitting (SJ3000 only)</p> <p>(Inch size) N1: ø1/8" One-touch fitting N3: ø5/32" One-touch fitting N7: ø1/4" One-touch fitting (SJ3000 only)</p>	<p>M3: M3 x 0.5 (SJ2000 only) M5: M5 x 0.8 (SJ3000 only)</p>	<p>Elbow fitting assembly (Upward entry) (Metric size) L2: ø2 elbow fitting assembly L4: ø4 elbow fitting assembly L6: ø6 elbow fitting assembly (SJ3000 only)</p> <p>(Inch size) LN1: ø1/8" elbow fitting assembly LN3: ø5/32" elbow fitting assembly LN7: ø1/4" elbow fitting assembly (SJ3000 only)</p>	<p>Elbow fitting assembly (Downward entry) (Metric size) B2: ø2 elbow fitting assembly B4: ø4 elbow fitting assembly B6: ø6 elbow fitting assembly (SJ3000 only)</p> <p>(Inch size) BN1: ø1/8" elbow fitting assembly BN3: ø5/32" elbow fitting assembly BN7: ø1/4" elbow fitting assembly (SJ3000 only)</p>
---	--	---	---

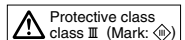

SJ2000/3000 Series

Dimensions

SS5J2-60- [Stations] U(S, R, RS)

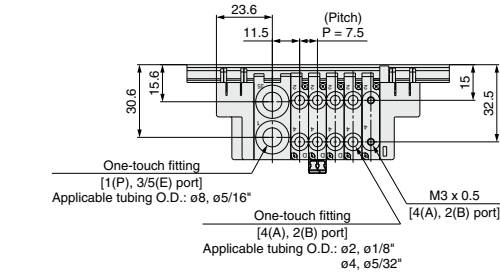

[External pilot specification]

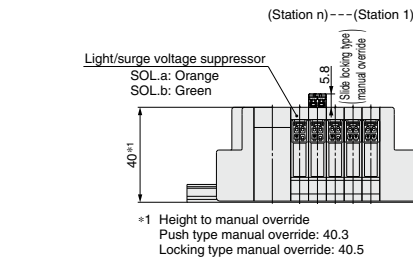
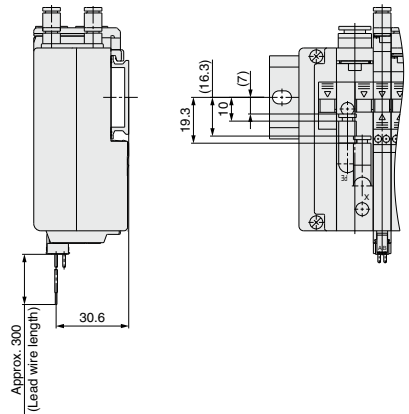
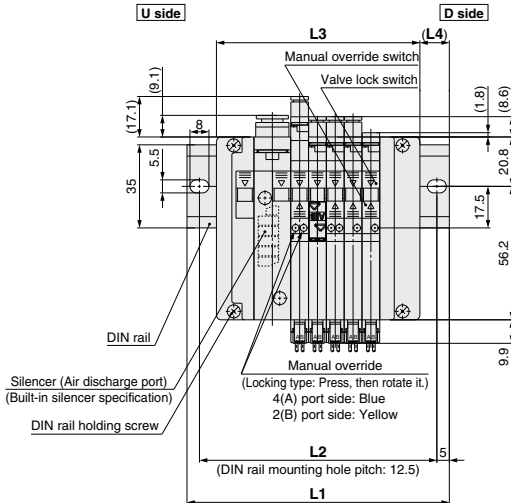
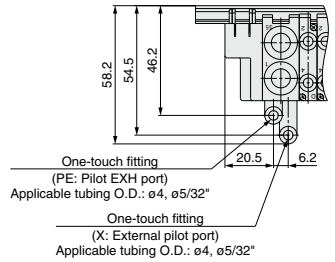

* For manifold dimensions including elbow fitting, refer to page 310.

L: Dimensions

n: Stations

L \ n	1	2	3	4	5	6	7	8	9	10	11	12	13	14	15	16	17	18	19	20
L1	85.5	98	98	110.5	110.5	123	135.5	135.5	148	148	160.5	173	173	185.5	185.5	198	210.5	210.5	223	223
L2	75	87.5	87.5	100	100	112.5	125	125	137.5	137.5	150	162.5	162.5	175	175	187.5	200	200	212.5	212.5
L3	55.7	63.2	70.7	78.2	85.7	93.2	100.7	108.2	115.7	123.2	130.7	138.2	145.7	153.2	160.7	168.2	175.7	183.2	190.7	198.2
L4	15	17.5	13.5	16	12.5	15	17.5	13.5	16	12.5	15	17.5	13.5	16	12.5	15	17.5	13.5	16	12.5

Dimensions

SS5J2-60- [Stations] B(S, R, RS)

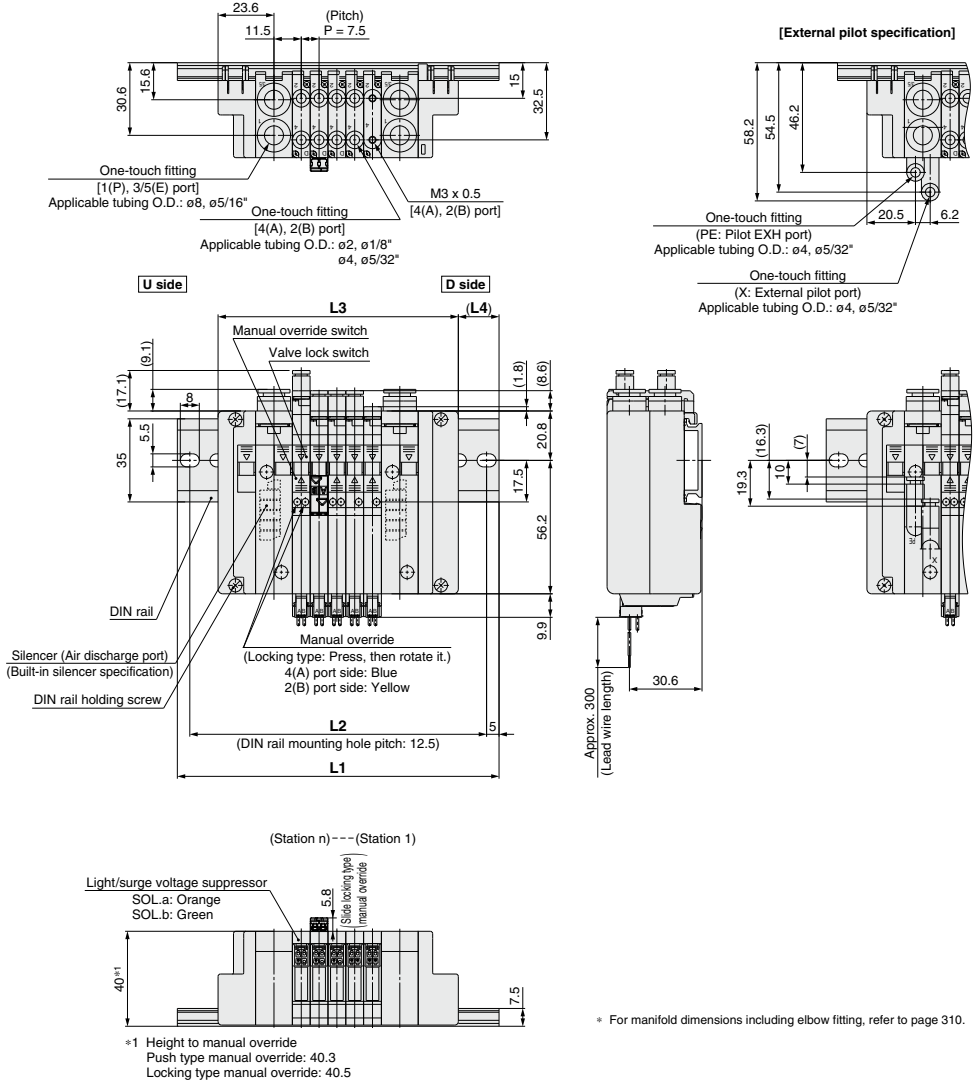

L: Dimensions

n: Stations

L	n	1	2	3	4	5	6	7	8	9	10	11	12	13	14	15	16	17	18	19	20
L1	98	110.5	110.5	123	135.5	135.5	148	148	160.5	173	173	185.5	185.5	198	210.5	210.5	223	223	235.5	248	
L2	87.5	100	100	112.5	125	125	137.5	137.5	150	162.5	162.5	175	175	187.5	200	200	212.5	212.5	225	237.5	
L3	71.2	78.7	86.2	93.7	101.2	108.7	116.2	123.7	131.2	138.7	146.2	153.7	161.2	168.7	176.2	183.7	191.2	198.7	206.2	213.7	
L4	13.5	16	12	14.5	17	13.5	16	12	14.5	17	13.5	16	12	14.5	17	13.5	16	12	14.5	17	

*1 Height to manual override
Push type manual override: 40.3
Locking type manual override: 40.5

SJ2000/3000 Series

Dimensions

SS5J3-60- [Stations] U(S, R, RS)

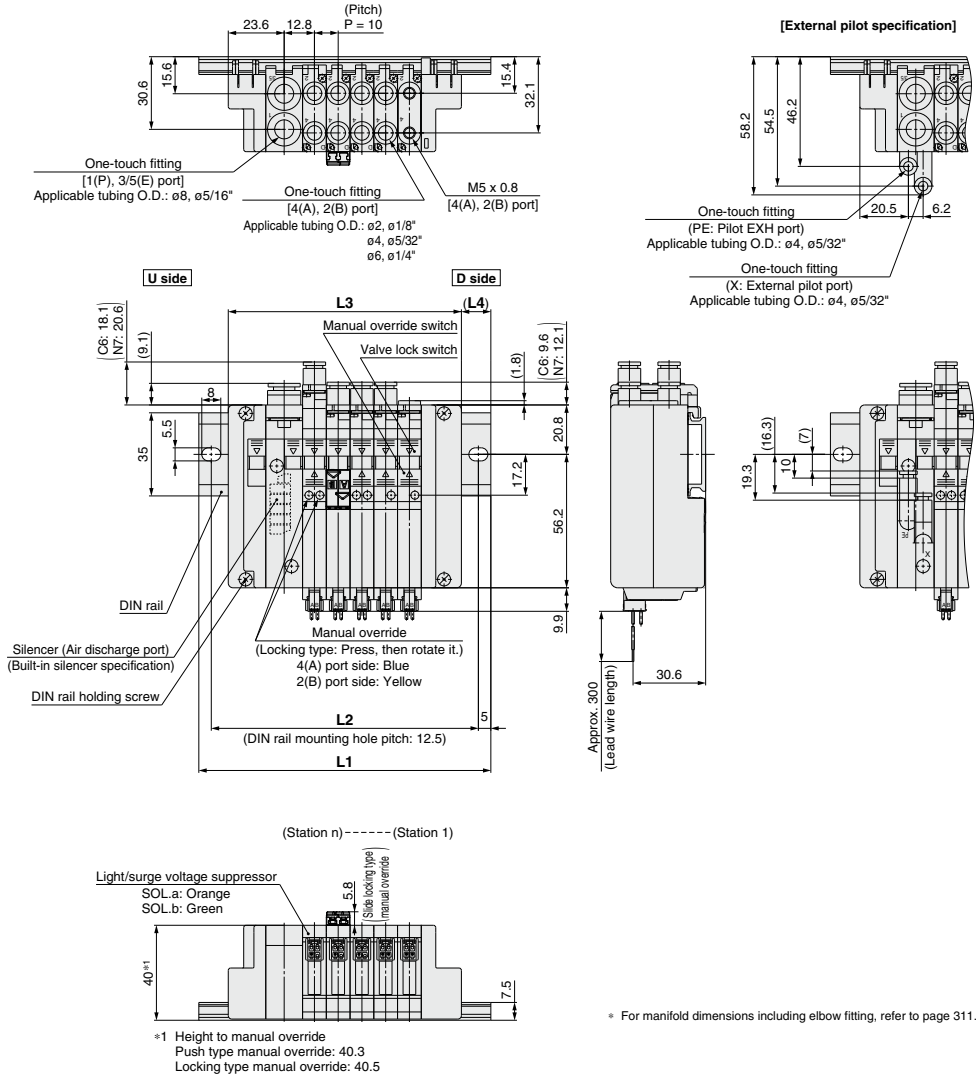

L: Dimensions

n: Stations

L \ n	1	2	3	4	5	6	7	8	9	10	11	12	13	14	15	16	17	18	19	20
L1	85.5	98	110.5	123	123	135.5	148	160.5	173	185.5	185.5	198	210.5	223	235.5	235.5	248	260.5	273	285.5
L2	75	87.5	100	112.5	112.5	125	137.5	150	162.5	175	175	187.5	200	212.5	225	225	237.5	250	262.5	275
L3	58.2	68.2	78.2	88.2	98.2	108.2	118.2	128.2	138.2	148.2	158.2	168.2	178.2	188.2	198.2	208.2	218.2	228.2	238.2	248.2
L4	13.5	14.5	16	17	12	13	14	15.5	16.5	17.5	12.5	13.5	15	16	17	12	13	14.5	15.5	16.5

Dimensions

SS5J3-60- [Stations] B(S, R, RS)

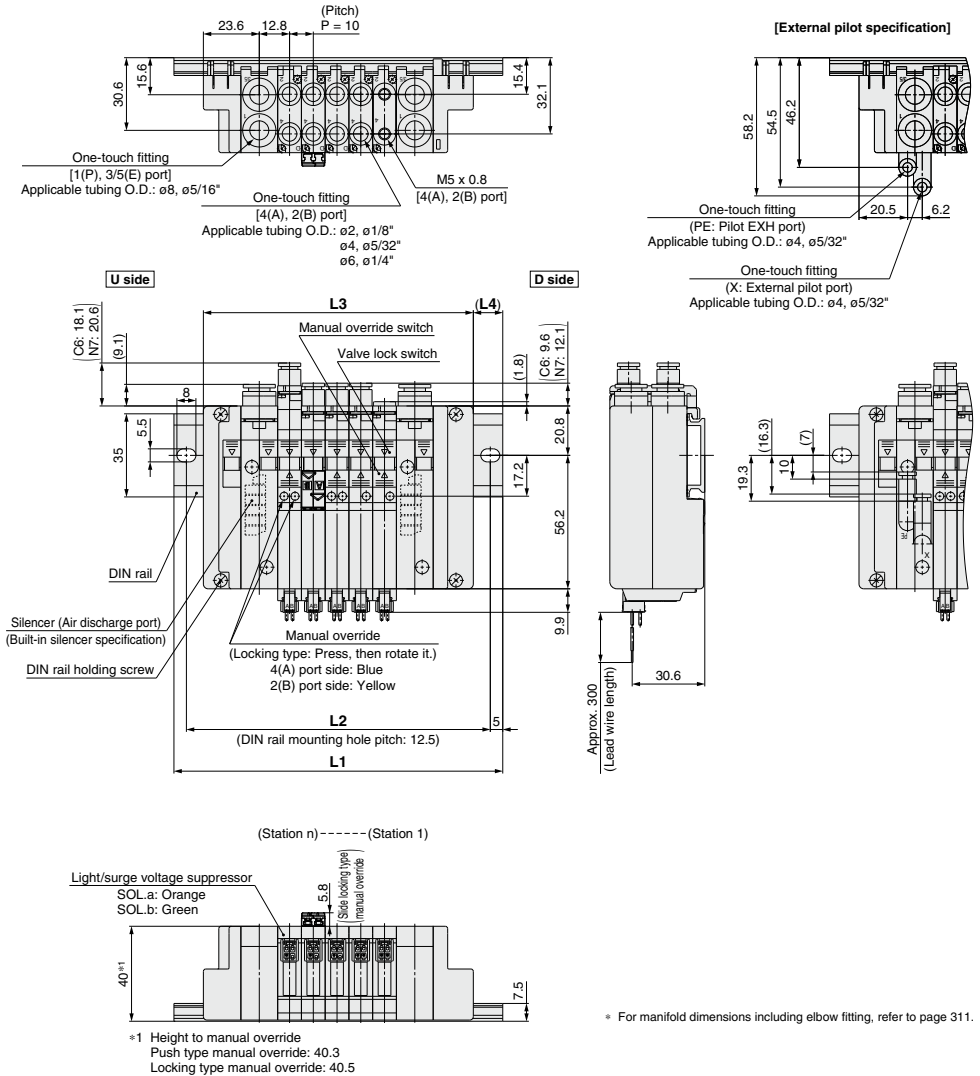

L: Dimensions

n: Stations

L	n	1	2	3	4	5	6	7	8	9	10	11	12	13	14	15	16	17	18	19	20
L1	98	110.5	123	135.5	148	148	160.5	173	185.5	198	210.5	210.5	223	235.5	248	260.5	260.5	273	285.5	298	
L2	87.5	100	112.5	125	137.5	137.5	150	162.5	175	187.5	200	200	212.5	225	237.5	250	250	262.5	275	287.5	
L3	73.7	83.7	93.7	103.7	113.7	123.7	133.7	143.7	153.7	163.7	173.7	183.7	193.7	203.7	213.7	223.7	233.7	243.7	253.7	263.7	
L4	12	13	14.5	15.5	16.5	11.5	12.5	14	15	16	17.5	12	13.5	14.5	15.5	17	11.5	13	14	15	

SJ2000/3000 Series

Dimensions: SJ2000/3000 Mixed Manifold

SS5J3-M60- [Stations] U(S, R, RS)

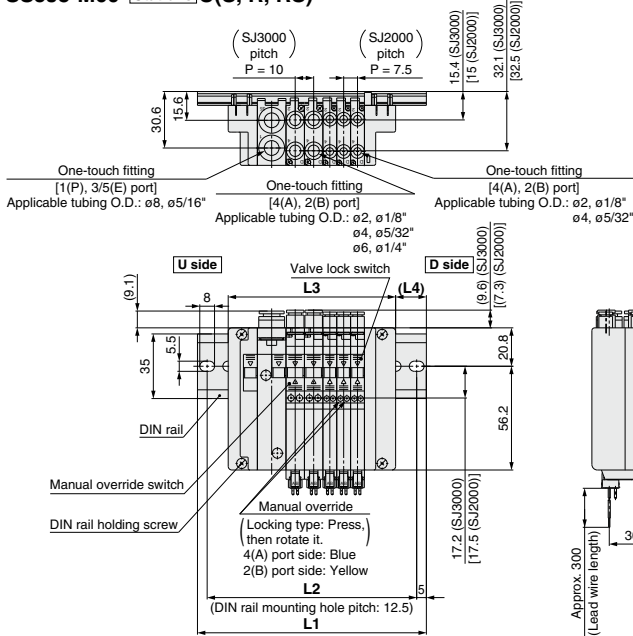

L dimension: Formula, L1 to L4
 $L3 = 7.5 \times n2 + 10 \times n3 + 48.2$
 $M = (L3 + 4) / 12.5 + 1$
 Decimal fractions are truncated.
 $L1 = M \times 12.5 + 23$
 $L2 = L1 - 10.5$
 $L4 = (L1 - L3) / 2 - 2$

n2 = Number of SJ2000
 n3 = Number of SJ3000

* The dimensions of L1 to L4 for SS5J3-M60- [Stations] D are the same as those of SS5J3-M60- [Stations] U.

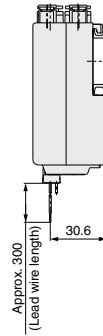

SS5J3-M60- [Stations] B(S, R, RS)

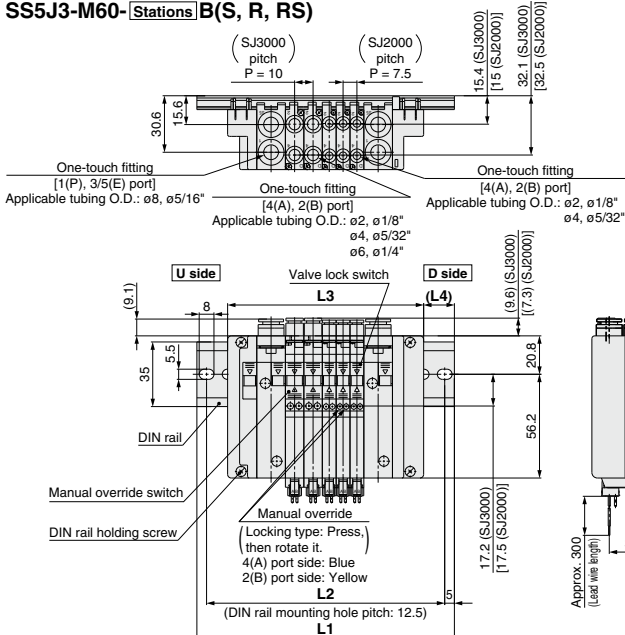

L dimension: Formula, L1 to L4
 $L3 = 7.5 \times n2 + 10 \times n3 + 63.7$
 $M = (L3 + 4) / 12.5 + 1$
 Decimal fractions are truncated.
 $L1 = M \times 12.5 + 23$
 $L2 = L1 - 10.5$
 $L4 = (L1 - L3) / 2 - 2$

n2 = Number of SJ2000
 n3 = Number of SJ3000

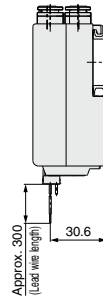

SJ2000/3000 Series Manifold Exploded View

Individual Wiring

Type 60 individual wiring (Non plug-in) manifold

* Refer to page 333 for "How to Increase Manifold Stations."

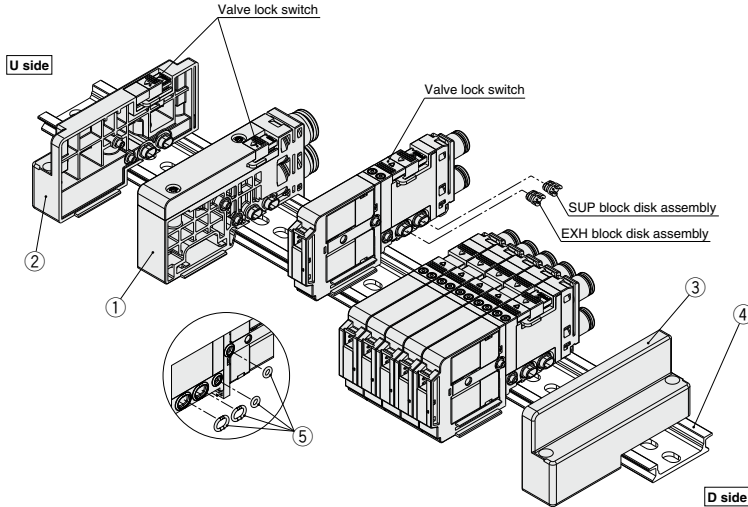

Component Parts: Individual Wiring (Non Plug-in)

No.	Description	Part no.	Note
1	Internal pilot	SJ3000-50-5A-□□	(Metric size)
	Internal pilot, Built-in silencer	SJ3000-50-5AS-□□	
	External pilot	SJ3000-50-5AR-□□ (X, PE port: Metric size ø4 Inch size ø5/32*)	C6: With ø6 One-touch fitting (straight) C8: With ø8 One-touch fitting (straight) L6: With ø6 One-touch fitting (elbow upward entry) L8: With ø8 One-touch fitting (elbow upward entry)
	External pilot, Built-in silencer	SJ3000-50-5ARS-□□ (X port: Metric size ø4 Inch size ø5/32*)	B6: With ø6 One-touch fitting (elbow downward entry) B8: With ø8 One-touch fitting (elbow downward entry)
	For different pressures, Internal pilot*1	SJ3000-50-6A-□□	(Inch size)
	For different pressures, Internal pilot, Built-in silencer*1	SJ3000-50-6AS-□□	N7: With 1/4" One-touch fitting (straight) N9: With 5/16" One-touch fitting (straight)
2	End block assembly	SJ3000-53-1A	For the U side
3	End block assembly	SJ3000-53-2A	For the D side
4	DIN rail	VZ1000-11-1-□	Refer to page 346.
5	O-ring for valve connection*2	SJ3000-96-1A	The part no. shown on the left includes parts for 5 units. (10 pcs. each for the P and E ports and for the X and PE ports)

*1 As the valves cannot be operated only with the SUP/EXH block assembly for different pressures, select them in combination with the SUP/EXH block assembly for internal/external pilot.

*2 Included with valves, SUP/EXH block assemblies, and connector block assemblies

* Refer to page 344 for the SUP/EXH block disk assembly and method of handling parts at different pressures.

SJ1000/2000/3000 Series Manifold Options

Common to Connector Type/Cable Type/Individual Wiring

■ SUP block disk assembly

By placing a SUP block disk assembly in a manifold valve's pressure supply passage, two different high and low pressures can be supplied to one manifold. When supplying different pressures using the manifold of the internal pilot, fill out a manifold specification sheet to place an order for a SUP/EXH block assembly for the internal pilot specifications and another SUP/EXH block assembly for the different pressure internal pilot specifications (Refer to Circuit Diagram 1).



Series	Part no.
SJ1000	
SJ2000	SJ3000-44-1A
SJ3000	

[Different pressure pneumatic circuit diagram]

● The SJ series supplies air to the pilot port of each valve using a 1(P) port of the SUP/EXH block assembly. When using in situations such as where there are different pressures, combine SUP/EXH block assemblies for internal pilot, external pilot, and different-pressure by referring to the circuit below.

1. Different-pressure specification using the internal pilot

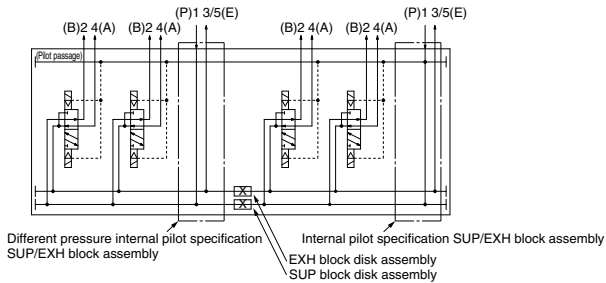

2. Different-pressure specification using the external pilot (For using the SUP/EXH block assembly for external pilot)

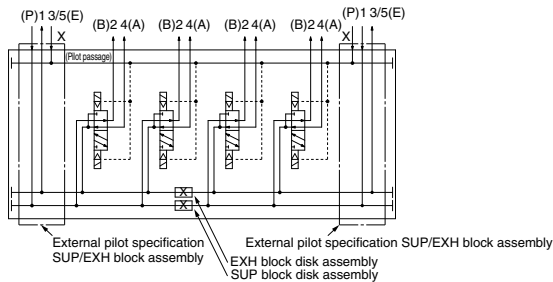

3. Different-pressure specification using the external pilot (For using the SUP/EXH block assembly for different-pressure internal pilot specification)

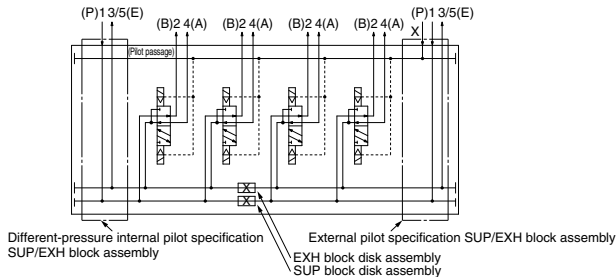

- * When operating under the different-pressure specification, supply the higher pressure to the pilot passage.
- * If there is a need to partition the pilot passage, please contact SMC.

Common to Connector Type/Cable Type/Individual Wiring

■ EXH block disk assembly

By installing an EXH block disk in a manifold valve's exhaust passage, the valve's exhaust can be separated so that it will not affect other valves.



Series	Part no.
SJ1000	SJ3000-44-1A
SJ2000	
SJ3000	

■ Label for block disk

These labels are attached to manifolds in which SUP and EXH block disks have been installed, in order to identify the installed locations. (Three sheets each included.)



* When a block disk is concurrently ordered by specifying on the manifold specification sheet, etc., a label will be stuck on the position where block disk is mounted.

SJ3000-155-1A

Label for SUP/EXH block disk

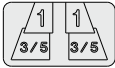

Label for SUP block disk

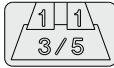

Label for EXH block disk

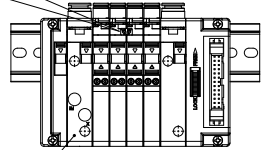
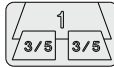

Internal pilot specification for different pressure SUP/EXH block assembly

■ Blanking block assembly

These are mounted when later addition of valves is planned, etc.

<Connector type/Individual wiring>

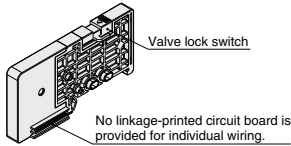

<Cable type>

Valve lock switch

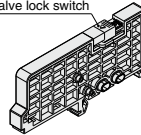

Valve lock switch

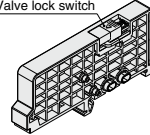

Series	Part no.	Note	Width
SJ1000	SJ3000-49-1A	Connector type (Single wiring)	7.5 mm
SJ2000	SJ3000-49-2A	Connector type (Double wiring)	
SJ3000	SJ3000-49-2A-N	Connector type (Double wiring)	
SJ3A6 *1	SJ3000-49-2A-N	Connector type (Double wiring)	
SJ2000	SJ3000-49-3A	Individual wiring	
SJ3000	SJ3000-49-3A		
SJ3A6 *1	SJ3000-49-3A-N		

Series	Part no.	Width
SJ2000	SJ2000-49-4A	7.5 mm
SJ3000	SJ3000-49-4A	10 mm
SJ3A6 *1	SJ3000-49-4A-N	

*1 Valve lock switch is not available for the SJ3A6.

*1 Valve lock switch is not available for the SJ3A6.

■ Silencer with One-touch fitting

This silencer can be mounted on the manifolds' port 3/5 (E: Exhaust) with a single touch.

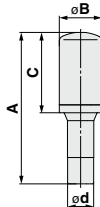

Series	Model	Effective area	A	B	C	ød
SJ1000 For SJ2000 (ø8) SJ3000	AN15-C08	20 mm ²	45 mm	13 mm	20 mm	ø8

■ Plug

These are inserted in unused cylinder ports and P, E ports.

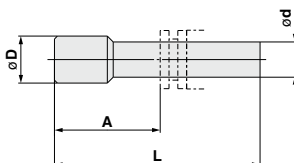

Dimensions

Applicable fitting size ød	Model	[mm]		
		A	L	D
2	KJP-02	8.2	17	3
4	KQ2P-04	16	32	6
6	KQ2P-06	18	35	8
8	KQ2P-08	20.5	39	10
1/8"	KQ2P-01	16	31.5	5
5/32"	KQ2P-03	16	32	6
1/4"	KQ2P-07	18	35	8.5
5/16"	KQ2P-09	20.5	39	10

SJ1000/2000/3000/4000 Series

Common to Connector Type/Cable Type/Individual Wiring

■ Silencer with One-touch fitting

This silencer can be mounted on the manifolds' port 3/5 (E: Exhaust) with a single touch.

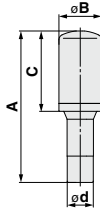

Series	Model	Effective area	A	B	C	ød
SJ1000 SJ2000 (ø8) SJ3000	AN15-C08	20 mm ²	45 mm	13 mm	20 mm	ø8
SJ4000 (ø10)	AN20-C10	30 mm ²	57.5 mm	16.5 mm	30.5 mm	ø10

■ Plug

These are inserted in unused cylinder ports and P, E ports.

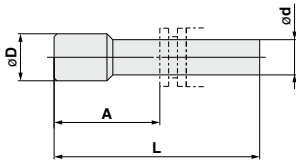

Dimensions

Applicable fitting size ød	Model	A	L	D
2	KJP-02	8.2	17	3
4	KQ2P-04	16	32	6
6	KQ2P-06	18	35	8
8	KQ2P-08	20.5	39	10
10	KQ2P-10	27.4	43	12
1/8"	KQ2P-01	16	31.5	5
5/32"	KQ2P-03	16	32	6
1/4"	KQ2P-07	18	35	8.5
5/16"	KQ2P-09	20.5	39	10

■ DIN rail

VZ1000-11-1-□

● L dimension

* Enter a number from the DIN rail dimension table shown below.

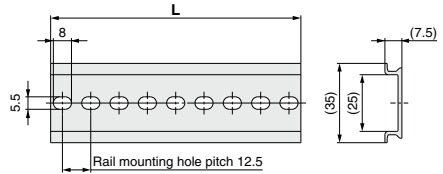

(Unit: mm)

No.	S1	0	1	2	3	4	5	6	7	8	9	10	11	12	13	14	15	16	17	18	19	20	21
L dimension	85.5	98	110.5	123	135.5	148	160.5	173	185.5	198	210.5	223	235.5	248	260.5	273	285.5	298	310.5	323	335.5	348	360.5
Weight [g]	15.4	17.6	19.9	22.1	24.4	26.6	28.9	31.1	33.4	35.6	37.9	40.1	42.4	44.6	46.9	49.1	51.4	53.6	55.9	58.1	60.4	62.6	64.9

No.	22	23	24	25	26	27	28	29	30	31	32	33	34	35	36	37	38	39	40	41	42	43	44
L dimension	373	385.5	398	410.5	423	435.5	448	460.5	473	485.5	498	510.5	523	535.5	548	560.5	573	585.5	598	610.5	623	635.5	648
Weight [g]	67.1	69.4	71.6	73.9	76.1	78.4	80.6	82.9	85.1	87.4	89.6	91.9	94.1	96.4	98.6	100.9	103.1	105.4	107.6	109.9	112.1	114.4	116.6

■ Flat ribbon cable assembly

AXT100-FC¹⁰₂₀₋₂¹⁰₂₆₋₃

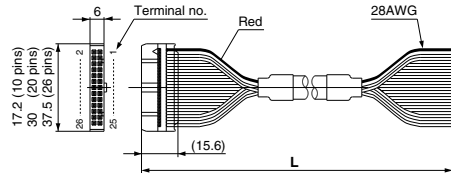

Flat ribbon cable connector

Cable length (L)	Assembly part no.		
	26 pins	20 pins	10 pins
1.5 m	AXT100-FC26-1	AXT100-FC20-1	AXT100-FC10-1
3 m	AXT100-FC26-2	AXT100-FC20-2	AXT100-FC10-2
5 m	AXT100-FC26-3	AXT100-FC20-3	AXT100-FC10-3

- * When using a standard commercial connector, use a 26-pin, 20-pin, or 10-pin type connector conforming to MIL-C-83503 with strain relief.
- * Cannot be used for movable wiring
- * Lengths other than the above are also available. Please contact SMC for details.

Connector Manufacturer's Example

- HIROSE ELECTRIC CO., LTD.
- 3M Japan Limited
- Fujitsu Limited
- Japan Aviation Electronics Industry, Limited
- J.S.T. Mfg. Co., Ltd.
- Oki Electric Cable Co., Ltd.

Common to Connector Type/Cable Type/Individual Wiring

■ Dual flow fitting (Set for SJ3000 series)

SJ3000-120-1A-C8

↓ Port size

C8	ø8
N9	ø5/16"

This is a fitting for cylinder ports which enables simultaneous actuation and increase in flow rate of valves for 2 stations.
This is a One-touch fitting with port sizes of ø8 and ø5/16".

* When arranging mounted to the valve, arrange the valve part no. using the part no. without the One-touch fitting, and then add the part no. for the dual flow fitting.
If the arrangement is too complicated, please specify the details on a manifold specification sheet.

Ordering example

Valve type (without One-touch fitting)

SJ3160-5CU-[C0] 2 sets

* SJ3000-120-1A-C8 1 set

↳ The asterisk denotes the symbol for the assembly.

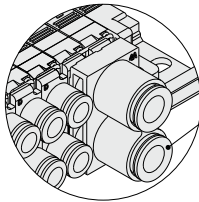

C8: ø8 One-touch fitting
N9: ø5/16" One-touch fitting

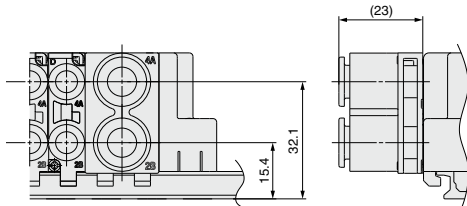

SJ1000/2000/3000 Series

For Connector Type/Individual Wiring

■ Regulator block/How to Order

This is used to reduce the pressure supplied from the D side inside the manifold. All valves on the U side are depressurized from the regulator block.

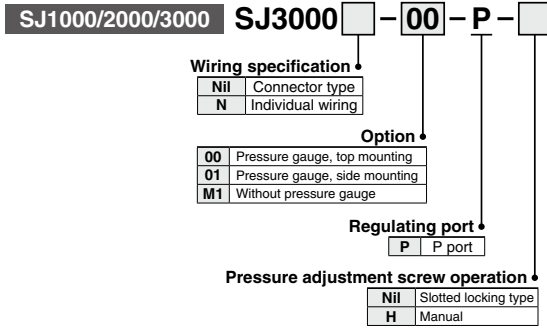

- * Be sure to apply the pressure from the 1(P) port of the manifold before using the regulator block.
- * When ordering with a regulator block installed in the manifold, please order using the manifold specification sheet.

■ Flow Rate Characteristics (Conditions: Inlet pressure 0.7 MPa when 2-position solenoid valve is mounted)

SJ1000

P port regulation (P → A, B)

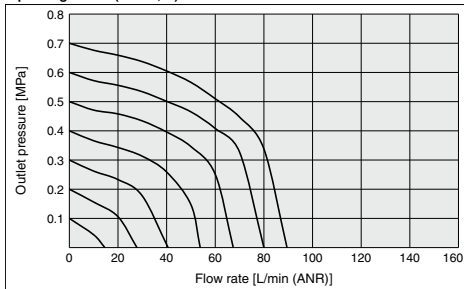

SJ2000

P port regulation (P → A, B)

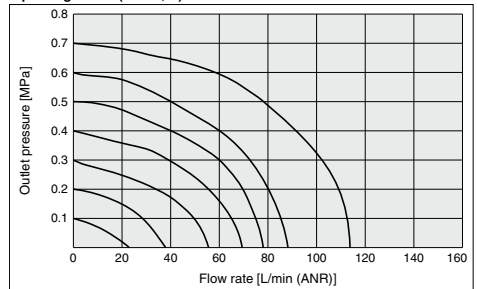

SJ3000

P port regulation (P → A, B)

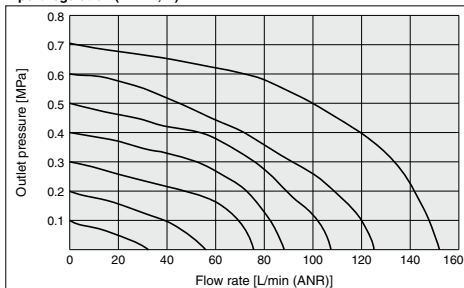

SJ3000(N)-00-P(-H)

With manual operation of pressure adjustment screw

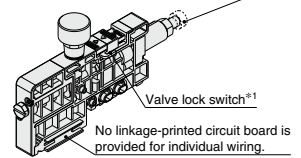

Pressure gauge, top mounting

SJ3000(N)-01-P(-H)

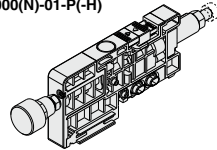

Pressure gauge, side mounting

SJ3000(N)-M1-P(-H)

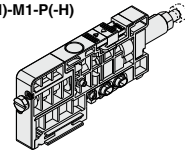

Without pressure gauge

- *1 The valve lock switch is available only for the SJ1000/2000/3000 series.

■ Pneumatic circuit (Regulator block mounting example)

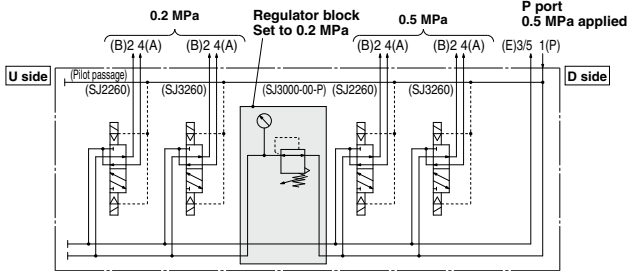

* Reduces supply pressure from the D side of manifold
Supply pressure from the U side cannot be reduced.

■ Dimensions

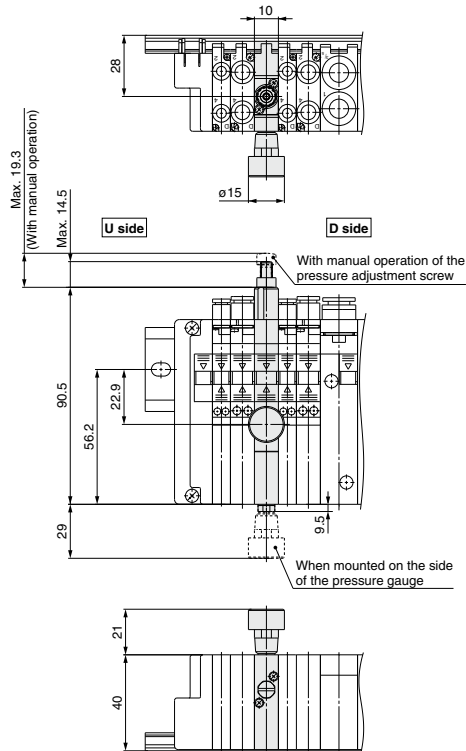

SJ1000/2000/3000 Series

For Connector Type/Individual Wiring

■ SUP/EXH block assembly with regulator and pressure switch (for internal pilot manifold)/How to Order

- * When mounting on the manifold, specify it on the manifold specification sheet.

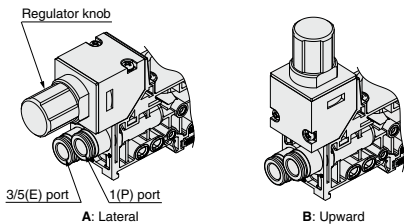
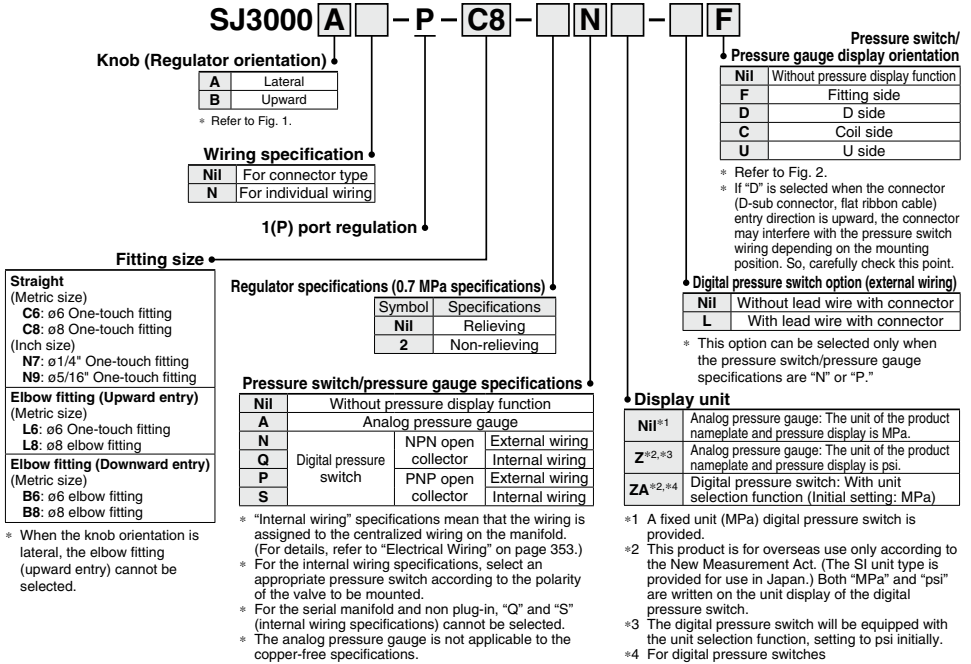
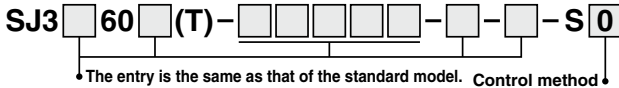

Fig. 1 Knob orientation (Regulator mounting orientation)

- * Be sure to apply the pressure from the 1(P) port of the manifold before using the SUP/EXH block assembly with regulator and pressure switch.
- * For details on the regulator and electric circuit of the external wiring specifications, refer to the catalog of the ARM11 series.
- * Applicable only to the manifolds with the internal pilot specifications
- * This regulator block cannot be combined with the vacuum release valve of the SJ3A6 series.

■ SJ3000 Series Valve with Speed Controller/How to Order



- | | | |
|----------|-----------|------------------------------|
| 0 | Meter-out | Identification color: Silver |
| 1 | Meter-in | Identification color: Black |
- *1 Set the operating torque of the speed controller to 0.1 N·m or less.
 - * Applicable only to the SJ3000 series
 - * Specify S0 or S1 at the end of the valve part no.

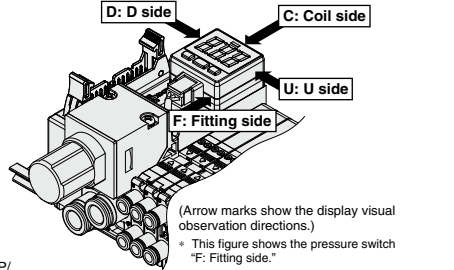
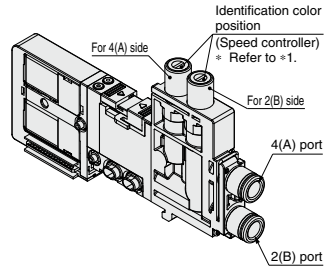

Fig. 2 Pressure switch/pressure gauge display orientation symbol



■ Flow rate characteristics

Regulator unit flow rate characteristics

SJ1000 passage P → A/B

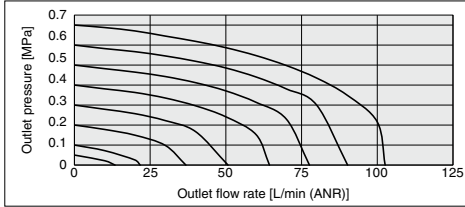

SJ2000 passage P → A/B

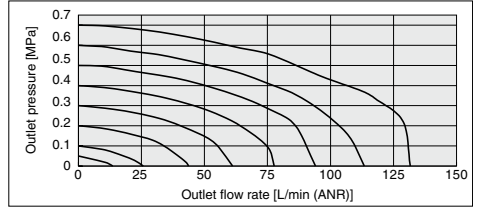

SJ3000 passage P → A/B

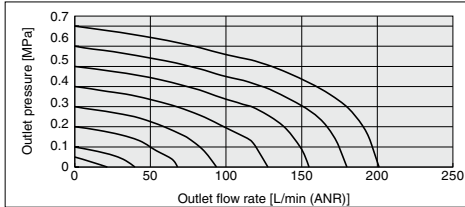

Valve with speed controller flow rate characteristics

Meter-out control A/B → E

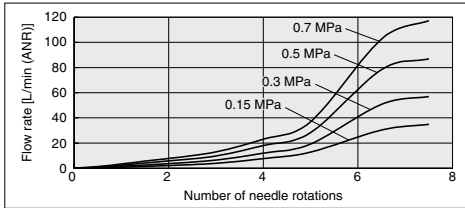

Meter-in control P → A/B

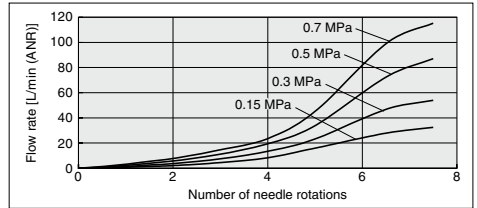

* The flow rate characteristics are characteristics of each individual product. Actual values may differ depending on the piping, circuitry, pressure conditions, etc. Also, depending on product specifications, there may be variations in the zero needle rotations position of the flow rate characteristics.

■ Pneumatic circuit

(Installation example of SUP/EXH block assembly with regulator and pressure switch, valve with speed controller)

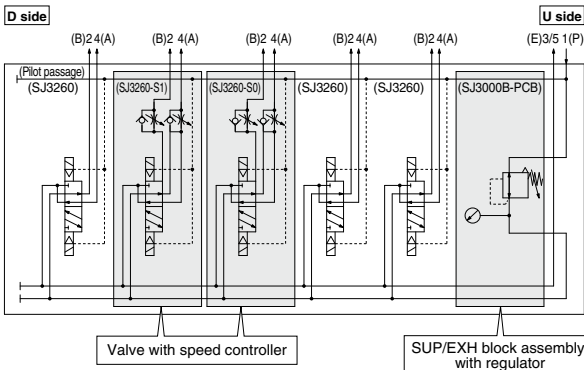

SJ1000/2000/3000 Series

For Connector Type/Individual Wiring

■ SUP/EXH block assembly with regulator and pressure switch, valve with speed controller/Dimensions

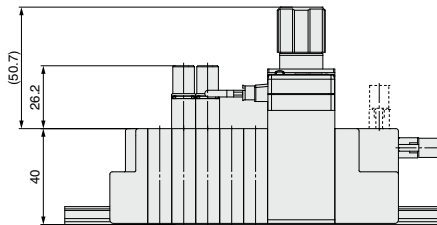
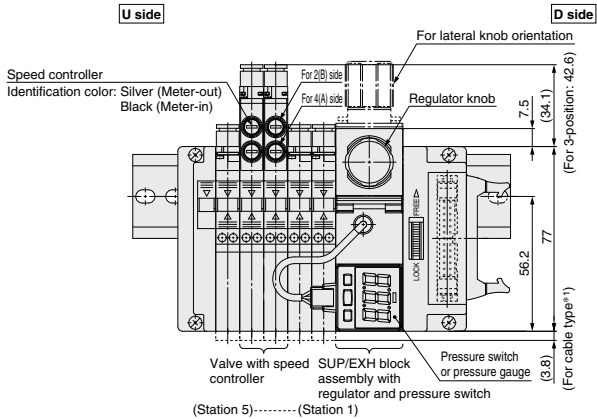
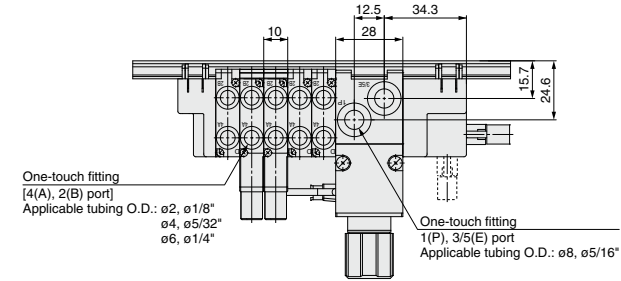

*1 The SUP/EXH block assembly with regulator and pressure switch cannot be mounted on the plug-in cable type manifold.

■ **Manifold electrical wiring when the SUP/EXH block assembly with the regulator and pressure switch is mounted (Internal wiring and pressure switch (NPN))**

D-sub connector (25 pins)

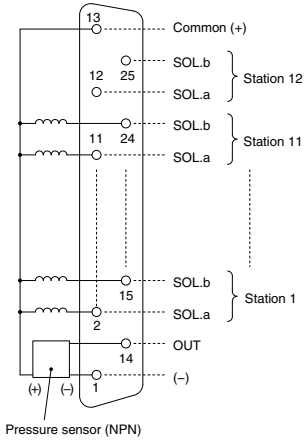

Flat ribbon cable (26 pins)

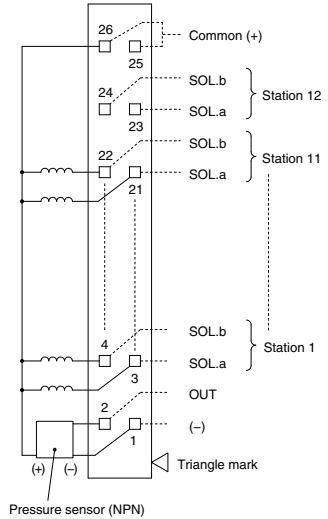

Flat ribbon cable (20 pins)

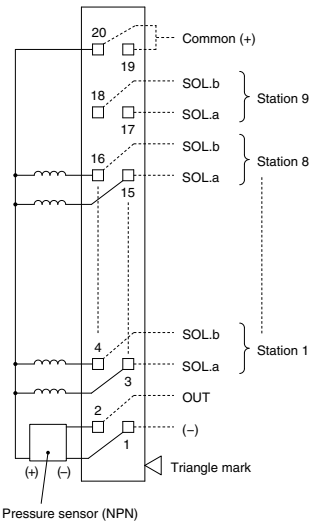

Flat ribbon cable (10 pins)

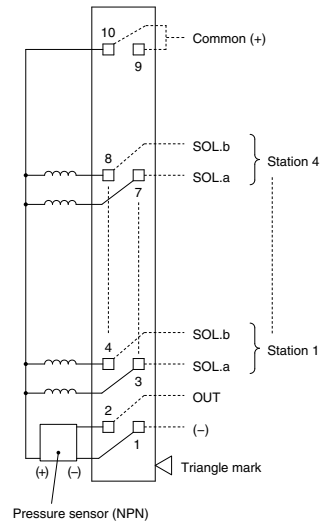

* This figure shows when the SUP/EXH block assembly with the regulator and pressure switch is mounted between the connector block and 1st station valve.

* Applicable only to the connector type manifold

SJ1000/2000/3000 Series

For connector type

Intermediate connector block assembly

This connector block can be used by inserting it into the middle of the manifold.

This can be used, for example, when you wish to separate electrical control of valves in the same manifold, or when the number of control points is insufficient.

Series	Part no.	Note
SJ1000 SJ2000	SJ3000-76-1A	Flat ribbon cable (20 pins)
SJ3000	SJ3000-76-4A	Flat ribbon cable (26 pins)

* When ordering with an intermediate connector block assembly installed in the manifold, please order using the manifold specification sheet.

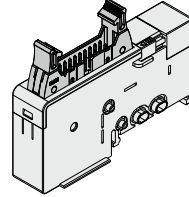

For flat ribbon cable (20 pins)

Intermediate connector block assembly wiring example

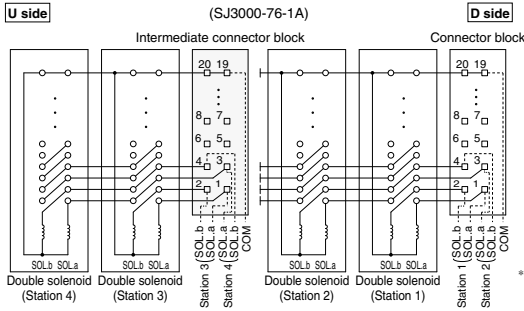

* Enables control of U side solenoid valves from the position where the intermediate connector block assembly is installed

Dimensions

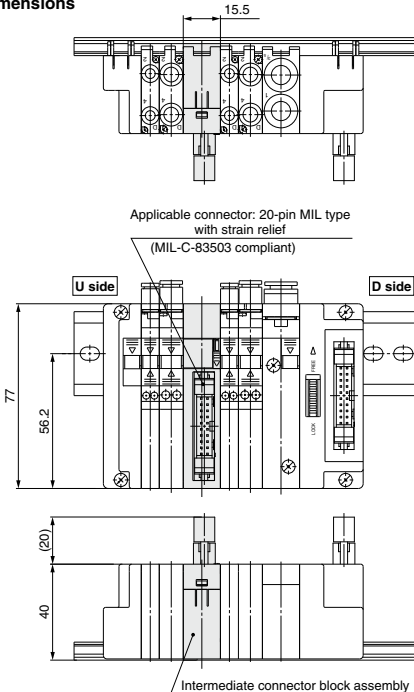

* This drawing shows the SJ3000-76-1A.

SJ1000/2000/3000 Series

Made to Order

Please contact SMC for detailed dimensions, specifications, and lead times.



1 Main Valve Fluororubber Specification

Symbol
-X90

Fluororubber is used for the rubber parts of the main valve to allow for use in the following situations.

1. When a lubricant other than the recommended turbine oil is used and there is a possibility of malfunction due to swelling of the spool valve seals
2. In environments where ozone may enter or is generated in the air supply

Part no. SJ $\begin{matrix} 2 \\ 3 \end{matrix}$ 60 (T) - - - -X90

• The entry is the same as that of the standard model.

* As fluororubber is only used for the main valve of the -X90 series, use in environments requiring heat resistance should be avoided.

2 Spring Return Specification (Dual 3-port Valve N.C./N.C.)

Symbol
-X110

When the supply pressure is exhausted, the main valve is forcibly returned to the OFF position by the built-in spring.

Part no. SJ1A60(K)T - - -X110

• The entry is the same as that of the standard model.

Response time: 20 ms
Max. operating frequency: 3 Hz
For other specifications, refer to the standard model.

Symbol

SJ1A60T

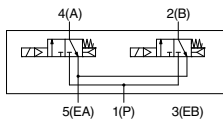

SJ1A60KT (With back pressure check valve)

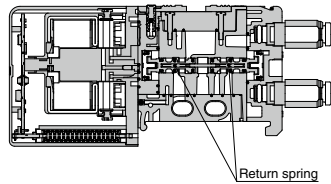
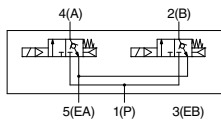

3 Low-profile SUP/EXH Block Assembly Specification

The low-profile SUP/EXH block assembly is 10.2 mm, which is smaller than the 15.5 mm standard SUP/EXH block assembly. This reduction results in space saving. The 1(P) port and the 3/5(E) port fittings are straight union (metric size) C6s: $\phi 6$ One-touch fittings.

4-port solenoid valve

Plug-in

Part no. **SS5J** $\frac{1}{2}$ - $\frac{2}{3}$ - **60** **D** - - **X225**

- The entry is the same as that of the standard model. However, there is no setting required for the pilot specification with a built-in silencer (S, RS).

Non plug-in

Part no. **SS5J** $\frac{2}{3}$ - **60** - - **X225**

- The entry is the same as that of the standard model. However, there is no setting required for the pilot specification with a built-in silencer (S, RS).

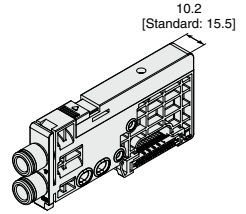

- * When the flow rate is insufficient, such as during the simultaneous operation of multiple valves, select the supply/exhaust block mounting position [B (both sides)] or use the standard manifold without using the -X225.
- * When ordering a manifold, specify the part nos. of the valves to be mounted on it. (An order cannot be placed with only the manifold part no.)
- * Check the "How to Order Manifolds" section of each valve to be mounted.
- * There is a made-to-order option that makes it so dual-flow fittings, etc., cannot be built into the manifold. Refer to the "Manifold Specifications Sheet" for more information.
- * When a silencer (AN10-C6) is used, it cannot be mounted next to a 3-position valve or a speed controller.

Flow Rate Characteristics

Series	Port size		Flow rate characteristics					
	1(P) 3/5(E)	4, 2 (A, B)	1 → 4/2 (P → A/B)			4/2 → 3/5 (A/B → E)		
			C [dm ³ /(s·bar)]	b	Cv	C [dm ³ /(s·bar)]	b	Cv
SJ1000	C6	C2	0.12	0.54	0.04	0.13	0.49	0.04
		C4	0.26	0.29	0.07	0.30	0.23	0.08
SJ2000	C6	C2	0.13	0.55	0.04	0.13	0.53	0.04
		C4	0.30	0.31	0.08	0.34	0.33	0.08
		M3	0.18	0.48	0.06	0.20	0.26	0.06
SJ3000	C6	C2	0.13	0.66	0.04	0.14	0.60	0.04
		C4	0.38	0.17	0.10	0.45	0.15	0.11
		C6	0.45	0.19	0.12	0.51	0.19	0.12
		M5	0.40	0.26	0.11	0.45	0.18	0.11

- * The values are for an individually operated 2-position type manifold base with 5 stations.

3 Low-profile SUP/EXH Block Assembly Specification

Symbol
-X225

Dimensions

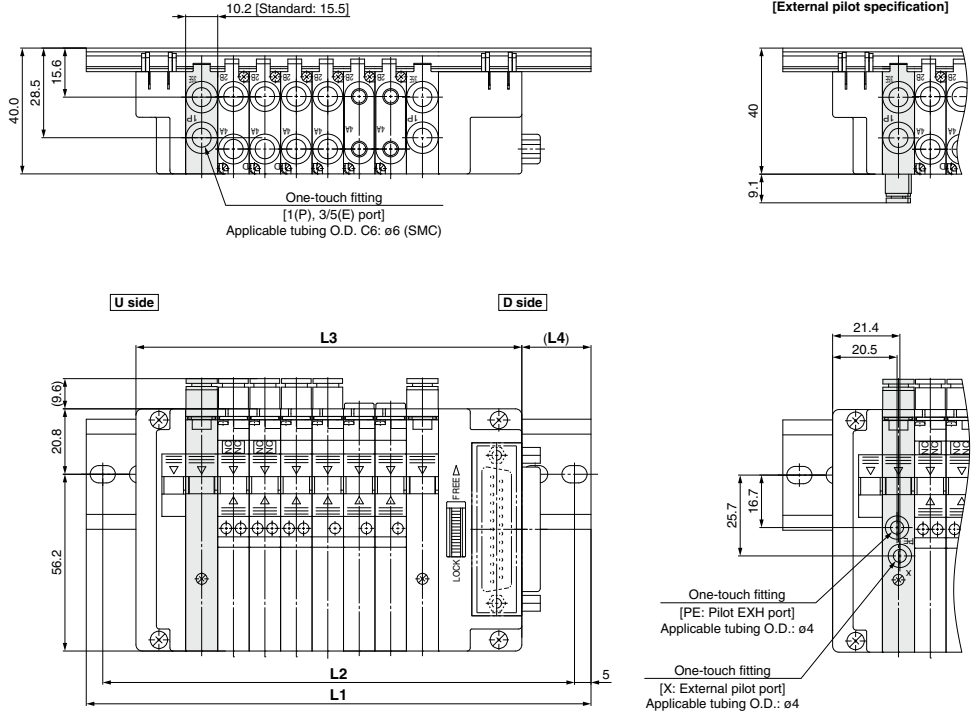

L: Dimensions

SS5J1-60FD□-□U-X225

n: Stations

L \ n	1	2	3	4	5	6	7	8	9	10	11	12	13	14	15	16	17	18	19	20	21	22	23	24
L1	98	98	110.5	110.5	123	123	135.5	135.5	148	148	160.5	160.5	173	173	185.5	185.5	198	210.5	210.5	223	223	235.5	235.5	248
L2	87.5	87.5	100	100	112.5	112.5	125	125	137.5	137.5	150	150	162.5	162.5	175	175	187.5	200	200	212.5	212.5	225	225	237.5
L3	59	65.5	72	78.5	85	91.5	98	104.5	111	117.5	124	130.5	137	143.5	150	156.5	163	169.5	176	182.5	189	195.5	202	208.5
L4	22.5	19	22	19	22	18.5	21.5	18.5	21.5	18	21	18	21	17.5	20.5	17.5	20.5	23.5	20	23	20	23	19.5	22.5

SS5J1-60FD□-□B-X225

n: Stations

L \ n	1	2	3	4	5	6	7	8	9	10	11	12	13	14	15	16	17	18	19	20	21	22	23	24
L1	110.5	110.5	123	123	135.5	135.5	148	148	160.5	160.5	173	173	185.5	185.5	198	198	210.5	210.5	223	223	235.5	235.5	248	248
L2	100	100	112.5	112.5	125	125	137.5	137.5	150	150	162.5	162.5	175	175	187.5	187.5	200	200	212.5	212.5	225	225	237.5	237.5
L3	69.2	75.7	82.2	88.7	95.2	101.7	108.2	114.7	121.2	127.7	134.2	140.7	147.2	153.7	160.2	166.7	173.2	179.7	186.2	192.7	199.2	205.7	212.2	218.7
L4	23.5	20.5	23.5	20	23	20	23	19.5	22.5	19.5	22.5	19	22	19	22	18.5	21.5	18.5	21.5	18	21	18	21	17.5

SJ1000/2000/3000 Series

Symbol

3 Low-profile SUP/EXH Block Assembly Specification

-X225

L: Dimensions

SS5J1-60PD□-□U-X225

n: Stations

L	n	1	2	3	4	5	6	7	8	9	10	11	12	13	14	15	16	17	18	19	20	21	22	23	24	
L1	98	98	110.5	110.5	123	123	135.5	135.5	148	148	160.5	160.5	173	185.5	185.5	198	198	210.5	210.5	223	223	235.5	235.5	248	248	
L2	87.5	87.5	100	100	112.5	112.5	125	125	137.5	137.5	150	150	162.5	175	175	187.5	187.5	200	200	212.5	212.5	225	225	237.5	237.5	
L3	59	65.5	72	78.5	85	91.5	98	104.5	111	117.5	124	130.5	137	143.5	150	156.5	163	169.5	176	182.5	189	195.5	202	208.5	208.5	
L4	23	19.5	22.5	19.5	22.5	19	22	19	22	18.5	21.5	18.5	21.5	24.5	21	24	21	24	24	20.5	23.5	20.5	23.5	20	23	23

SS5J1-60PD□-□B-X225

n: Stations

L	n	1	2	3	4	5	6	7	8	9	10	11	12	13	14	15	16	17	18	19	20	21	22	23	24
L1	110.5	110.5	123	123	135.5	135.5	148	148	160.5	160.5	173	173	185.5	185.5	198	198	210.5	210.5	223	223	235.5	235.5	248	248	260.5
L2	100	100	112.5	112.5	125	125	137.5	137.5	150	150	162.5	162.5	175	175	187.5	187.5	200	200	212.5	212.5	225	225	237.5	237.5	250
L3	69.2	75.7	82.2	88.7	95.2	101.7	108.2	114.7	121.2	127.7	134.2	140.7	147.2	153.7	160.2	166.7	173.2	179.7	186.2	192.7	199.2	205.7	212.2	218.7	218.7
L4	24	20.5	23.5	20.5	23.5	20	23	20	23	19.5	22.5	19.5	22.5	19	22	19	22	18.5	21.5	18.5	21.5	18	21	24	24

SS5J1-60SV/Q□D-□U-X225

n: Stations

L	n	1	2	3	4	5	6	7	8	9	10	11	12	13	14	15	16
L1	123	123	135.5	135.5	148	148	160.5	160.5	173	173	185.5	185.5	198	198	210.5	210.5	
L2	112.5	112.5	125	125	137.5	137.5	150	150	162.5	162.5	175	175	187.5	187.5	200	200	
L3	89.4	95.9	102.4	108.9	115.4	121.9	128.4	134.9	141.4	147.9	154.4	160.9	167.4	173.9	180.4	186.9	
L4	17	13.5	16.5	13.5	16.5	13	16	13	16	12.5	15.5	12.5	15.5	12	15	12	

L	n	17	18	19	20	21	22	23	24	25	26	27	28	29	30	31	32
L1	223	223	235.5	248	248	260.5	260.5	273	273	285.5	285.5	298	298	310.5	310.5	323	
L2	212.5	212.5	225	237.5	237.5	250	250	262.5	262.5	275	275	287.5	287.5	300	300	312.5	
L3	193.4	199.9	206.4	212.9	219.4	225.9	232.4	238.9	245.4	251.9	258.4	264.9	271.4	277.9	284.4	290.9	
L4	15	11.5	14.5	17.5	14.5	17.5	14	17	14	17	13.5	16.5	13.5	16.5	13	16	

SS5J1-60SV/Q□D-□B-X225

n: Stations

L	n	1	2	3	4	5	6	7	8	9	10	11	12	13	14	15	16
L1	123	135.5	148	148	160.5	160.5	173	173	185.5	185.5	198	198	210.5	210.5	223	223	
L2	112.5	125	137.5	137.5	150	150	162.5	162.5	175	175	187.5	187.5	200	200	212.5	212.5	
L3	99.6	106.1	112.6	119.1	125.6	132.1	138.6	145.1	151.6	158.1	164.6	171.1	177.6	184.1	190.6	197.1	
L4	11.5	14.5	17.5	14.5	17.5	14	17	14	17	13.5	16.5	13.5	16.5	13	16	13	

L	n	17	18	19	20	21	22	23	24	25	26	27	28	29	30	31	32
L1	235.5	235.5	248	248	260.5	260.5	273	273	285.5	285.5	298	298	310.5	310.5	323	323	
L2	225	225	237.5	237.5	250	250	262.5	262.5	275	275	287.5	287.5	300	300	312.5	312.5	
L3	203.6	210.1	216.6	223.1	229.6	236.1	242.6	249.1	255.6	262.1	268.6	275.1	281.6	288.1	294.6	301.1	
L4	16	12.5	15.5	12.5	15.5	12	15	12	15	11.5	14.5	11.5	14.5	11	14	11	

SS5J1-60S6B□D-□U-X225

n: Stations

L	n	1	2	3	4	5	6	7	8	9	10	11	12	13	14	15	16
L1	135.5	148	148	160.5	160.5	173	173	185.5	185.5	198	198	210.5	210.5	223	223	235.5	
L2	125	137.5	137.5	150	150	162.5	162.5	175	175	187.5	187.5	200	200	212.5	212.5	225	
L3	106.6	113.1	119.6	126.1	132.6	139.1	145.6	152.1	158.6	165.1	171.6	178.1	184.6	191.1	197.6	204.1	
L4	14.5	17.5	14	17	14	17	13.5	16.5	13.5	16.5	13	16	13	16	12.5	15.5	

SS5J1-60S6B□D-□B-X225

n: Stations

L	n	1	2	3	4	5	6	7	8	9	10	11	12	13	14	15	16
L1	148	148	160.5	160.5	173	173	185.5	185.5	198	198	210.5	210.5	223	223	235.5	235.5	
L2	137.5	137.5	150	150	162.5	162.5	175	175	187.5	187.5	200	200	212.5	212.5	225	225	
L3	116.8	123.3	129.8	136.3	142.8	149.3	155.8	162.3	168.8	175.3	181.8	188.3	194.8	201.3	207.8	214.3	
L4	15.5	12.5	15.5	12	15	12	15	11.5	14.5	11.5	14.5	11.5	14.5	11	14	11	

3 Low-profile SUP/EXH Block Assembly Specification

Symbol
-X225

L: Dimensions

SS5J2-60FD□-□U-X225

n: Stations

L \ n	1	2	3	4	5	6	7	8	9	10	11	12	13	14	15	16	17	18	19	20	21	22	23	24		
L1	98	98	110.5	123	123	135.5	135.5	148	160.5	160.5	173	173	185.5	198	198	210.5	210.5	223	235.5	235.5	248	248	260.5	273	273	
L2	87.5	87.5	100	112.5	112.5	125	125	137.5	150	150	162.5	162.5	175	187.5	187.5	200	200	212.5	225	225	237.5	237.5	250	262.5	262.5	
L3	60	67.5	75	82.5	90	97.5	105	112.5	120	127.5	135	142.5	150	157.5	165	172.5	180	187.5	195	202.5	210	217.5	225	232.5	232.5	
L4	22	18	20.5	23	19.5	22	18	20.5	23	19.5	22	18	20.5	23	19.5	22	18	20.5	23	19.5	22	18	20.5	23	20.5	23

SS5J2-60FD□-□B-X225

n: Stations

L \ n	1	2	3	4	5	6	7	8	9	10	11	12	13	14	15	16	17	18	19	20	21	22	23	24	
L1	110.5	110.5	123	123	135.5	148	148	160.5	160.5	173	185.5	185.5	198	198	210.5	223	223	235.5	235.5	248	260.5	260.5	273	273	273
L2	100	100	112.5	112.5	125	137.5	137.5	150	150	162.5	175	175	187.5	187.5	200	212.5	212.5	225	225	237.5	250	250	262.5	262.5	262.5
L3	70.2	77.7	85.2	92.7	100.2	107.7	115.2	122.7	130.2	137.7	145.2	152.7	160.2	167.7	175.2	182.7	190.2	197.7	205.2	212.7	220.2	227.7	235.2	242.7	242.7
L4	23	19.5	22	18.5	23	19.5	22	18	20.5	23	19.5	22	18	20.5	23	19.5	22	18	20.5	23	19.5	22	18	20.5	23

SS5J2-60PD□-□U-X225

n: Stations

L \ n	1	2	3	4	5	6	7	8	9	10	11	12	13	14	15	16	17	18	19	20	21	22	23	24	
L1	98	98	110.5	123	123	135.5	135.5	148	160.5	160.5	173	173	185.5	198	198	210.5	210.5	223	235.5	235.5	248	248	260.5	273	273
L2	87.5	87.5	100	112.5	112.5	125	125	137.5	150	150	162.5	162.5	175	187.5	187.5	200	200	212.5	225	225	237.5	237.5	250	262.5	262.5
L3	60	67.5	75	82.5	90	97.5	105	112.5	120	127.5	135	142.5	150	157.5	165	172.5	180	187.5	195	202.5	210	217.5	225	232.5	232.5
L4	22.5	18.5	21	23.5	20	22.5	18.5	21	23.5	20	22.5	18.5	21	23.5	20	22.5	18.5	21	23.5	20	22.5	18.5	21	23.5	23.5

SS5J2-60PD□-□B-X225

n: Stations

L \ n	1	2	3	4	5	6	7	8	9	10	11	12	13	14	15	16	17	18	19	20	21	22	23	24	
L1	110.5	110.5	123	123	135.5	148	148	160.5	160.5	173	185.5	185.5	198	198	210.5	223	223	235.5	235.5	248	260.5	260.5	273	273	273
L2	100	100	112.5	112.5	125	137.5	137.5	150	150	162.5	175	175	187.5	187.5	200	212.5	212.5	225	225	237.5	250	250	262.5	262.5	262.5
L3	70.2	77.7	85.2	92.7	100.2	107.7	115.2	122.7	130.2	137.7	145.2	152.7	160.2	167.7	175.2	182.7	190.2	197.7	205.2	212.7	220.2	227.7	235.2	242.7	242.7
L4	23.5	19.5	22	18.5	21	23.5	19.5	22	18.5	21	23.5	19.5	22	18.5	21	23.5	19.5	22	18.5	21	23.5	19.5	22	18.5	18.5

SS5J2-60SV/Q□D-□U-X225

n: Stations

L \ n	1	2	3	4	5	6	7	8	9	10	11	12	13	14	15	16
L1	123	123	135.5	148	148	160.5	160.5	173	185.5	185.5	198	198	210.5	223	223	235.5
L2	112.5	112.5	125	137.5	137.5	150	150	162.5	175	175	187.5	187.5	200	212.5	212.5	225
L3	90.4	97.9	105.4	112.9	120.4	127.9	135.4	142.9	150.4	157.9	165.4	172.9	180.4	187.9	195.4	202.9
L4	16.5	12.5	15	17.5	14	16.5	12.5	15	17.5	14	16.5	12.5	15	17.5	14	16.5

L \ n	17	18	19	20	21	22	23	24	25	26	27	28	29	30	31	32
L1	235.5	248	260.5	260.5	273	273	285.5	298	298	310.5	310.5	323	323	335.5	348	348
L2	225	237.5	250	250	262.5	262.5	275	287.5	287.5	300	300	312.5	312.5	325	325	337.5
L3	210.4	217.9	225.4	232.9	240.4	247.9	255.4	262.9	270.4	277.9	285.4	292.9	300.4	307.9	315.4	322.9
L4	12.5	15	17.5	14	16.5	12.5	15	17.5	14	16.5	12.5	15	17.5	14	16.5	12.5

SS5J2-60SV/Q□D-□B-X225

n: Stations

L \ n	1	2	3	4	5	6	7	8	9	10	11	12	13	14	15	16
L1	135.5	135.5	148	148	160.5	173	173	185.5	185.5	198	210.5	210.5	223	223	235.5	248
L2	125	125	137.5	137.5	150	162.5	162.5	175	175	187.5	200	200	212.5	212.5	225	237.5
L3	100.6	108.1	115.6	123.1	130.6	138.1	145.6	153.1	160.6	168.1	175.6	183.1	190.6	198.1	205.6	213.1
L4	17.5	13.5	16	12.5	15	17.5	13.5	16	12.5	15	17.5	13.5	16	12.5	15	17.5

L \ n	17	18	19	20	21	22	23	24	25	26	27	28	29	30	31	32
L1	248	260.5	260.5	273	285.5	285.5	298	298	310.5	323	323	335.5	335.5	348	360.5	360.5
L2	237.5	250	250	262.5	275	275	287.5	287.5	300	312.5	312.5	325	325	337.5	350	350
L3	220.6	228.1	235.6	243.1	250.6	258.1	265.6	273.1	280.6	288.1	295.6	303.1	310.6	318.1	325.6	333.1
L4	13.5	16	12.5	15	17.5	13.5	16	12.5	15	17.5	13.5	16	12.5	15	17.5	13.5

SJ1000/2000/3000 Series

Symbol

3 Low-profile SUP/EXH Block Assembly Specification

-X225

L: Dimensions

SS5J2-60S6B□D-□U-X225

n: Stations

L	n	1	2	3	4	5	6	7	8	9	10	11	12	13	14	15	16
L1		135.5	148	148	160.5	173	173	185.5	185.5	198	210.5	210.5	223	235.5	235.5	248	248
L2		125	137.5	137.5	150	162.5	162.5	175	175	187.5	200	200	212.5	225	225	237.5	237.5
L3		107.6	115.1	122.6	130.1	137.6	145.1	152.6	160.1	167.6	175.1	182.6	190.1	197.6	205.1	212.6	220.1
L4		14	16.5	12.5	15	17.5	14	16.5	12.5	15	17.5	14	16.5	19	15	17.5	14

SS5J2-60S6B□D-□B-X225

n: Stations

L	n	1	2	3	4	5	6	7	8	9	10	11	12	13	14	15	16
L1		148	160.5	160.5	173	173	185.5	198	198	210.5	210.5	223	235.5	235.5	248	260.5	260.5
L2		137.5	150	150	162.5	162.5	175	187.5	187.5	200	200	212.5	225	225	237.5	250	250
L3		117.8	125.3	132.8	140.3	147.8	155.3	162.8	170.3	177.8	185.3	192.8	200.3	207.8	215.3	222.8	230.3
L4		15	17.5	14	16.5	12.5	15	17.5	14	16.5	12.5	15	17.5	14	16.5	19	15

SS5J2-60-□U-X225

n: Stations

L	n	1	2	3	4	5	6	7	8	9	10	11	12	13	14	15	16	17	18	19	20
L1		85.5	85.5	98	98	110.5	123	123	135.5	135.5	148	160.5	160.5	173	173	185.5	198	198	210.5	210.5	223
L2		75	75	87.5	87.5	100	112.5	112.5	125	125	137.5	150	150	162.5	162.5	175	187.5	187.5	200	200	212.5
L3		50.4	57.9	65.4	72.9	80.4	87.9	95.4	102.9	110.4	117.9	125.4	132.9	140.4	147.9	155.4	162.9	170.4	177.9	185.4	192.9
L4		17.5	14	16.5	12.5	15	17.5	14	16.5	12.5	15	17.5	14	16.5	12.5	15	17.5	14	16.5	12.5	15

SS5J2-60-□B-X225

n: Stations

L	n	1	2	3	4	5	6	7	8	9	10	11	12	13	14	15	16	17	18	19	20
L1		85.5	98	110.5	110.5	123	123	135.5	148	148	160.5	160.5	173	185.5	185.5	198	198	210.5	223	223	235.5
L2		75	87.5	100	100	112.5	112.5	125	137.5	137.5	150	150	162.5	175	175	187.5	187.5	200	212.5	212.5	225
L3		60.6	68.1	75.6	83.1	90.6	98.1	105.6	113.1	120.6	128.1	135.6	143.1	150.6	158.1	165.6	173.1	180.6	188.1	195.6	203.1
L4		12.5	15	17.5	13.5	16	12.5	15	17.5	13.5	16	12.5	15	17.5	13.5	16	12.5	15	17.5	13.5	16

SS5J3-60FD□-□U-X225

n: Stations

L	n	1	2	3	4	5	6	7	8	9	10	11	12	13	14	15	16	17	18	19	20	21	22	23	24
L1		98	110.5	123	123	135.5	148	160.5	173	185.5	185.5	198	210.5	223	235.5	235.5	248	260.5	273	285.5	285.5	298	310.5	323	335.5
L2		87.5	100	112.5	112.5	125	137.5	150	162.5	175	175	187.5	200	212.5	225	225	237.5	250	262.5	275	275	287.5	300	312.5	325
L3		62.5	72.5	82.5	92.5	102.5	112.5	122.5	132.5	142.5	152.5	162.5	172.5	182.5	192.5	202.5	212.5	222.5	232.5	242.5	252.5	262.5	272.5	282.5	292.5
L4		20.5	22	23	18	19	20	21.5	22.5	23.5	18.5	19.5	21	22	23	18	19	20.5	21.5	22.5	17.5	18.5	20	21	22

SS5J3-60FD□-□B-X225

n: Stations

L	n	1	2	3	4	5	6	7	8	9	10	11	12	13	14	15	16	17	18	19	20	21	22	23	24
L1		110.5	123	123	135.5	148	160.5	173	185.5	185.5	198	210.5	223	235.5	235.5	248	260.5	273	285.5	285.5	298	310.5	323	335.5	348
L2		100	112.5	112.5	125	137.5	150	162.5	175	175	187.5	200	212.5	225	225	237.5	250	262.5	275	275	287.5	300	312.5	325	337.5
L3		72.7	82.7	92.7	102.7	112.7	122.7	132.7	142.7	152.7	162.7	172.7	182.7	192.7	202.7	212.7	222.7	232.7	242.7	252.7	262.7	272.7	282.7	292.7	302.7
L4		22	23	18	19	20	21.5	22.5	23.5	18.5	19.5	21	22	23	18	19	20.5	21.5	22.5	17.5	18.5	20	21	22	23

SS5J3-60PD□-□U-X225

n: Stations

L	n	1	2	3	4	5	6	7	8	9	10	11	12	13	14	15	16	17	18	19	20	21	22	23	24
L1		98	110.5	123	123	135.5	148	160.5	173	185.5	185.5	198	210.5	223	235.5	235.5	248	260.5	273	285.5	285.5	298	310.5	323	335.5
L2		87.5	100	112.5	112.5	125	137.5	150	162.5	175	175	187.5	200	212.5	225	225	237.5	250	262.5	275	275	287.5	300	312.5	325
L3		62.5	72.5	82.5	92.5	102.5	112.5	122.5	132.5	142.5	152.5	162.5	172.5	182.5	192.5	202.5	212.5	222.5	232.5	242.5	252.5	262.5	272.5	282.5	292.5
L4		21	22	23.5	18	19.5	20.5	21.5	23	24	19	20	21	22.5	23.5	18.5	19.5	20.5	22	23	24	19	20	21.5	22.5

SS5J3-60PD□-□B-X225

n: Stations

L	n	1	2	3	4	5	6	7	8	9	10	11	12	13	14	15	16	17	18	19	20	21	22	23	24
L1		110.5	123	123	135.5	148	160.5	173	185.5	185.5	198	210.5	223	235.5	235.5	248	260.5	273	285.5	285.5	298	310.5	323	335.5	348
L2		100	112.5	112.5	125	137.5	150	162.5	175	175	187.5	200	212.5	225	225	237.5	250	262.5	275	275	287.5	300	312.5	325	337.5
L3		72.7	82.7	92.7	102.7	112.7	122.7	132.7	142.7	152.7	162.7	172.7	182.7	192.7	202.7	212.7	222.7	232.7	242.7	252.7	262.7	272.7	282.7	292.7	302.7
L4		22	23.5	18	19.5	20.5	21.5	23	24	19	20	21	22.5	23.5	18.5	19.5	20.5	22	23	24	19	20	21.5	22.5	23.5

3 Low-profile SUP/EXH Block Assembly Specification

Symbol
-X225

L: Dimensions

SS5J3-60SV/Q□D-□U-X225

n: Stations

L \ n	1	2	3	4	5	6	7	8	9	10	11	12	13	14	15	16
L1	123	135.5	148	148	160.5	173	185.5	198	198	210.5	223	235.5	248	260.5	260.5	273
L2	112.5	125	137.5	137.5	150	162.5	175	187.5	187.5	200	212.5	225	237.5	250	250	262.5
L3	92.9	102.9	112.9	122.9	132.9	142.9	152.9	162.9	172.9	182.9	192.9	202.9	212.9	222.9	232.9	242.9
L4	15	16	17.5	12	13.5	14.5	15.5	17	11.5	13	14	15	16.5	17.5	12.5	13.5

L \ n	17	18	19	20	21	22	23	24	25	26	27	28	29	30	31	32
L1	285.5	298	310.5	310.5	323	335.5	348	360.5	373	373	385.5	398	410.5	423	423	435.5
L2	275	287.5	300	300	312.5	325	337.5	350	362.5	362.5	375	387.5	400	412.5	412.5	425
L3	252.9	262.9	272.9	282.9	292.9	302.9	312.9	322.9	332.9	342.9	352.9	362.9	372.9	382.9	392.9	402.9
L4	14.5	16	17	12	13	14	15.5	16.5	17.5	12.5	13.5	15	16	17	12	13

SS5J3-60SV/Q□D-□B-X225

n: Stations

L \ n	1	2	3	4	5	6	7	8	9	10	11	12	13	14	15	16
L1	135.5	148	148	160.5	173	185.5	198	198	210.5	223	235.5	248	260.5	260.5	273	285.5
L2	125	137.5	137.5	150	162.5	175	187.5	187.5	200	212.5	225	237.5	250	250	262.5	275
L3	103.1	113.1	123.1	133.1	143.1	153.1	163.1	173.1	183.1	193.1	203.1	213.1	223.1	233.1	243.1	253.1
L4	16	17.5	12	13.5	14.5	15.5	17	11.5	13	14	15	16.5	17.5	12.5	13.5	14.5

L \ n	17	18	19	20	21	22	23	24	25	26	27	28	29	30	31	32
L1	298	310.5	310.5	323	335.5	348	360.5	373	373	385.5	398	410.5	423	423	435.5	448
L2	287.5	300	300	312.5	325	337.5	350	362.5	362.5	375	387.5	400	412.5	412.5	425	437.5
L3	263.1	273.1	283.1	293.1	303.1	313.1	323.1	333.1	343.1	353.1	363.1	373.1	383.1	393.1	403.1	413.1
L4	16	17	12	13	14	15.5	16.5	17.5	12.5	13.5	15	16	17	12	13	14.5

SS5J3-60S6B□D-□U-X225

n: Stations

L \ n	1	2	3	4	5	6	7	8	9	10	11	12	13	14	15	16
L1	135.5	148	160.5	173	185.5	185.5	198	210.5	223	235.5	235.5	248	260.5	273	285.5	298
L2	125	137.5	150	162.5	175	175	187.5	200	212.5	225	225	237.5	250	262.5	275	287.5
L3	110.1	120.1	130.1	140.1	150.1	160.1	170.1	180.1	190.1	200.1	210.1	220.1	230.1	240.1	250.1	260.1
L4	12.5	14	15	16.5	17.5	12.5	14	15	16.5	17.5	12.5	14	15	16.5	17.5	19

SS5J3-60S6B□D-□B-X225

n: Stations

L \ n	1	2	3	4	5	6	7	8	9	10	11	12	13	14	15	16
L1	148	160.5	173	185.5	185.5	198	210.5	223	235.5	235.5	248	260.5	273	285.5	298	298
L2	137.5	150	162.5	175	175	187.5	200	212.5	225	225	237.5	250	262.5	275	287.5	287.5
L3	120.3	130.3	140.3	150.3	160.3	170.3	180.3	190.3	200.3	210.3	220.3	230.3	240.3	250.3	260.3	270.3
L4	14	15	16.5	17.5	12.5	14	15	16.5	17.5	12.5	14	15	16.5	17.5	19	14

SS5J3-60-□U-X225

n: Stations

L \ n	1	2	3	4	5	6	7	8	9	10	11	12	13	14	15	16	17	18	19	20
L1	85.5	98	98	110.5	123	135.5	148	148	160.5	173	185.5	198	210.5	210.5	223	235.5	248	260.5	260.5	273
L2	75	87.5	87.5	100	112.5	125	137.5	137.5	150	162.5	175	187.5	200	200	212.5	225	237.5	250	250	262.5
L3	52.9	62.9	72.9	82.9	92.9	102.9	112.9	122.9	132.9	142.9	152.9	162.9	172.9	182.9	192.9	202.9	212.9	222.9	232.9	242.9
L4	16	17.5	12.5	13.5	14.5	15.5	17	12	13	14	15	16.5	17.5	12.5	13.5	14.5	16	17	12	13

SS5J3-60-□B-X225

n: Stations

L \ n	1	2	3	4	5	6	7	8	9	10	11	12	13	14	15	16	17	18	19	20
L1	98	98	110.5	123	135.5	148	148	160.5	173	185.5	198	210.5	210.5	223	235.5	248	260.5	260.5	273	285.5
L2	87.5	87.5	100	112.5	125	137.5	137.5	150	162.5	175	187.5	200	200	212.5	225	237.5	250	250	262.5	275
L3	63.1	73.1	83.1	93.1	103.1	113.1	123.1	133.1	143.1	153.1	163.1	173.1	183.1	193.1	203.1	213.1	223.1	233.1	243.1	253.1
L4	17.5	12.5	13.5	14.5	15.5	17	12	13	14	15	16.5	17.5	12.5	13.5	14.5	16	17	12	13	14

Vacuum Release Valve with Restrictor

SJ3A6 Series

Plug-in Type

p. 366 **Connector Connection**
D-sub Connector
Flat Ribbon Cable
Serial Wiring: EX180
Serial Wiring: EX510

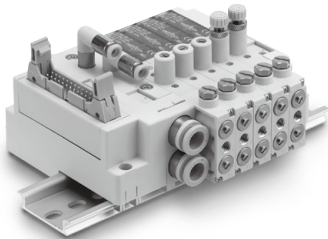

p. 368 **Cable Connection**
D-sub Connector
Flat Ribbon Cable

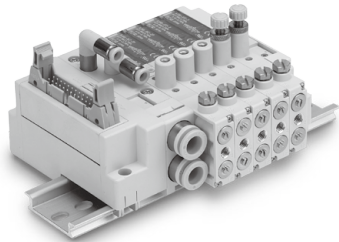

Non Plug-in Type Individual Wiring

p. 372 **Individual Wiring**

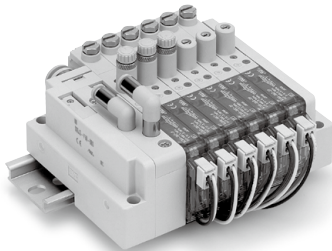

Vacuum Release Valve with Restrictor

SJ3A6 Series

Common Specifications

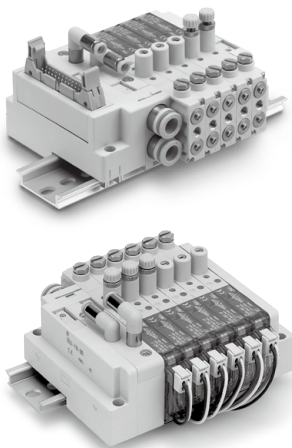

Manifold Valve Specifications

Valve construction		3-position 3-port valve with restrictor
Fluid		Air
Operating pressure range [MPa]	Release pressure port 1(P)	0.25 to 0.7
	Vacuum pressure port 3/5(E)	-100 kPa to 0.7* ¹
	Pilot X port	0.25 to 0.7* ²
Ambient and fluid temperatures [°C]		-10 to 50 (No freezing)
Max. operating frequency [Hz]		3
Manual override (Manual operation)		Non-locking push type
		Push-turn locking slotted type
Restrictor operation		Manual
		Slotted locking type
Pilot method		External pilot/Pilot valve individual exhaust
Lubrication		Not required
Mounting orientation		Unrestricted
Impact/Vibration resistance [m/s²]³		150/30
Enclosure		Dustproof

- *1 Can be used with positive pressure to suit the application
 *2 Please use with pilot X port pressure equal to or higher than the release port 1(P) pressure.
 *3 Impact resistance : No malfunction occurred when it is tested with a drop tester in the axial direction and at the right angles to the main valve and armature in both energized and de-energized states every once for each condition. (Value in the initial state)
- Vibration resistance: No malfunction occurred in one sweep test between 45 and 2000 Hz in the axial direction and at the right angles to the main valve and armature in both energized and de-energized states for each condition. (Value in the initial state)

Symbol

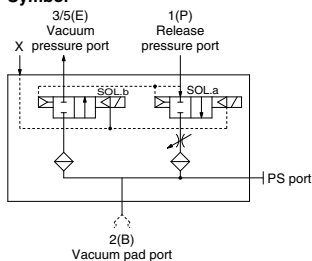

Solenoid Specifications

Coil rated voltage		24 VDC, 12 VDC
Allowable voltage fluctuation		±10% of rated voltage* ¹
Power consumption [W]	Standard	0.4
	With power-saving circuit (Continuous duty type)	0.15* ² [Starting 0.4, Holding 0.15]
Surge voltage suppressor		Diode
Indicator type		LED

- *1 For the allowable voltage fluctuation for Z/T type (with power-saving circuit), please observe the following range because they have voltage drop due to internal circuit.
 Z type 24 VDC: -7% to +10%
 12 VDC: -4% to +10%
 T type 24 VDC: -5% to +10%
 12 VDC: -6% to +10%
 *2 Refer to page 379 for details.

Response Time

Valve model	Response time [ms] (at 0.5 MPa)
SJ3A6-□□-□	19

Weight

Valve model	Weight [g]
SJ3A6-□□-P	79

Flow Rate Characteristics

Flow Rate Characteristics (When restrictor is fully open)

Valve model	Fluid passage 1(P) → 2(B)			2(B) → 3/5(E)			
	2(B) Port size	C [dm ³ /(s·bar)]	b	Cv	C [dm ³ /(s·bar)]	b	Cv
SJ3A6-□□-□	M5	0.24	0.19	0.05	0.40	0.18	0.10

Restrictor Flow Rate Characteristics (Fluid passage: 1(P) → 2(B))

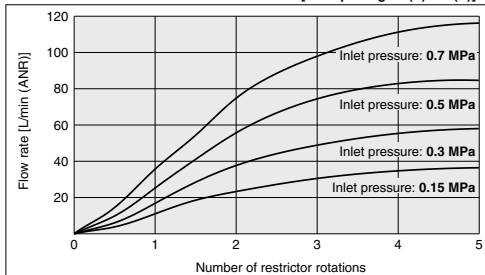

SJ3A6 Series

Construction/Circuit Example

Construction

Connector type

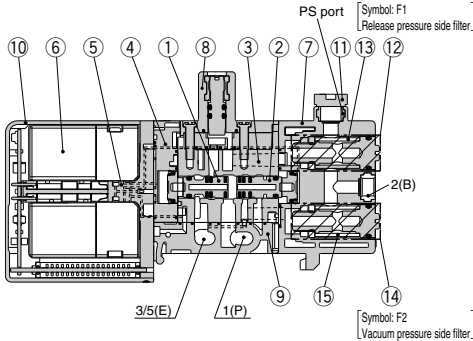

Cable type

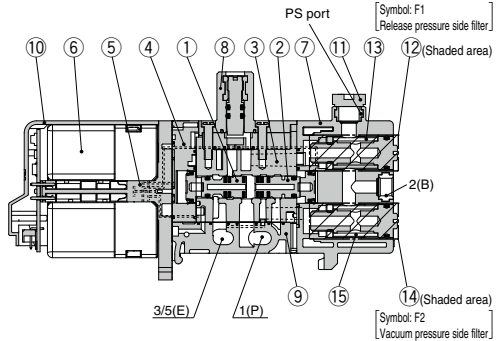

Component Parts

No.	Description	Material	Note
1	Spool valve assembly	Resin/HNBR	A side (for release pressure switching)
2	Spool valve assembly	Resin/HNBR	B side (for vacuum pressure switching)
3	Body	Zinc die-cast	—
4	Adapter plate	Resin	White
5	Pilot adapter	Resin	White
6	Pilot valve assembly	—	—
7	End cover	Resin	White
8	Restrictor block assembly*1	Resin	White
9	Bottom cover	Resin	White
10	Light cover	Resin	Light blue

*1 Set the operating torque of the restrictor of the restrictor block assembly to 0.3 N·m or less.

Component Parts

No.	Description	Part no.	Note
11	Plug	M-5P	PS port with plug
12	Filter assembly	SJ3000-110-1A	1 μm White <Release pressure side>
13	Filter	SJ3000-107-1A	1 μm White <Release pressure side>, 5 pcs. included
14	Filter assembly	SJ3000-110-2A	30 μm Light purple <Vacuum pressure side>
15	Filter	SJ3000-107-2A	30 μm Light purple <Vacuum pressure side>, 5 pcs. included

<Filter replacement instructions>

If there are situations such as filter clogging, a drop in suction force, or slow response time, stop operation and replace the filter.

- Using a precision driver, remove the filter assembly (12 or 14) from the main unit.
- Turn the filter guide by hand and remove.
- Replace the filter (13 or 15) and gently hand tighten the filter guide. At this time, check that there is no foreign matter on the O-ring of the filter assembly.
- Return the filter assembly to the main unit. (Tightening torque: 0.12 N·m)

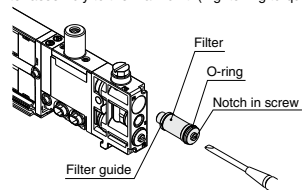

After tightening the plug (M-5P) with a tightening torque of 1 N·m, or manually tightening, use the tightening tool and tighten it by 1/4 turn.

12/14 Filter assembly (with filter)

13/15 Filter (5 pcs. included)

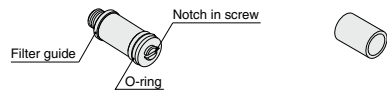

Adsorbing and Transferring System Circuit Example

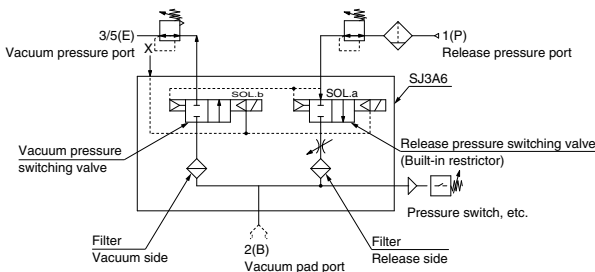

SJ3A6 Series

An order cannot be placed with only the manifold part no. Be sure to order solenoid valves for mounting at the same time while referring to the ordering example.

How to Order

● Vacuum release valve manifold with restrictor

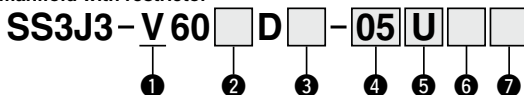

1 Vacuum release valve with restrictor type

2 Connector type

Symbol	Mounting position	Page	Note
F	D-sub connector	290	Parallel wiring
P	Flat ribbon cable 26 pins		
PG	Flat ribbon cable 20 pins		
PH	Flat ribbon cable 10 pins		
S□	EX180 serial transmission	312	Serial wiring
S6B□	EX510 serial transmission	322	

3 Connector entry

With parallel wiring specifications, it is necessary to select the connector entry direction (1: upward, 2: lateral). For details, refer to page 290.

4 Valve stations

F: D-sub connector

Symbol	Stations
01	1 station
⋮	⋮
12	12 stations

P: Flat ribbon cable (26 pins)

Symbol	Stations
01	1 station
⋮	⋮
12	12 stations

PG: Flat ribbon cable (20 pins)

Symbol	Stations
01	1 station
⋮	⋮
09	9 stations

PH: Flat ribbon cable (10 pins)

Symbol	Stations
01	1 station
⋮	⋮
04	4 stations

S6B□: EX510 serial transmission



Symbol	Stations
01	1 station
⋮	⋮
08	8 stations

S□: EX180 serial transmission

Symbol	Stations	Note
01	1 station	There are limitations on the station number, depending on the serial type. Refer to page 312 for details.
⋮	⋮	
16	16 stations	

* This number also includes the blanking block assembly. For the blanking block assembly, please select double wiring specifications.

6 SUP/EXH block fitting specification

	NII	L	B
Straight fitting			
X, PE port:			
Elbow fitting	Elbow fitting (Upward)	Elbow fitting (Downward)	Elbow fitting
	X, PE port: Straight fitting	X, PE port: Elbow fitting	

* There is no need to enter anything when the SUP/EXH block mounting position "M" is selected. Also, this manifold comes standard with external pilot specifications.

5 SUP/EXH block mounting position

U	U side
D	D side
B	Both sides
M ^{*1}	Special specifications

*1 Specify the required specifications (including port sizes other than ø8) on the manifold specification sheet.

7 DIN rail length specified

NII	Standard length
2	2 stations
⋮	⋮
16	16 stations

* Specify the number of valve stations without exceeding the max. number of stations.

How to Order Manifold Assembly

Ordering example (SS3J3-V60PD2-□)

Individual wiring, lead wire length 300 mm, with plug (24 VDC)
 SJ3A6-5MZ-P (1 set)

With switch, plug (24 VDC)
 SJ3A6-5CZJ-P (1 set)
 Non-polar type, with plug (24 VDC)
 SJ3A6-5CU-DP (4 sets)

SUP/EXH block (D side mounting)

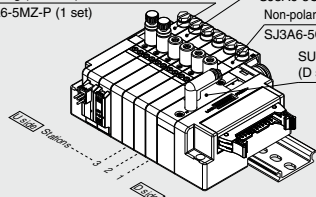

SS3J3-V60PD2-06D..... 1 set (Manifold part no.)
 * SJ3A6-5CU-DP 4 sets (Non-polar type, with plug part no.)
 * SJ3A6-5CZJ-P 1 set (With switch, plug part no.)
 * SJ3A6-5MZ-P 1 set (Individual wiring, lead wire length 300 mm, with plug part no.)

The asterisk denotes the symbol for the assembly. Prefix it to the part numbers of the solenoid valve, etc.

· For the valve arrangement, the valve closest to the D side is considered the 1st station.
 · Under the manifold part number, state the valves to be mounted in order starting with the 1st station as shown in the figure. If the arrangement becomes too complicated, specify the details on a manifold specification sheet.
 * When ordering a manifold, specify the part nos. of the valves to be mounted on it (An order cannot be placed with only the manifold part no.)

How to Order Solenoid Valves (3-Position 3-Port with Restrictor)

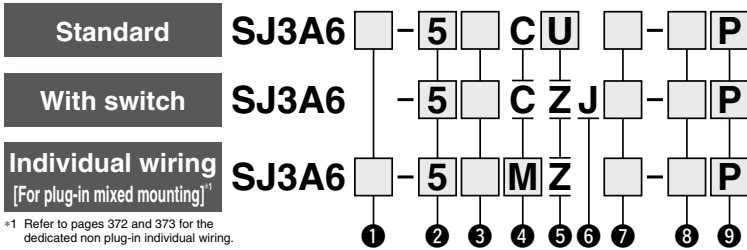

*1 Refer to pages 372 and 373 for the dedicated non plug-in individual wiring.

1 Coil type

Nil	Standard
T	With power-saving circuit (Continuous duty type)

* Be sure to select the power-saving circuit type if the valve is to be continuously energized for long periods of time.

2 Rated voltage

5	24 VDC
6	12 VDC

* Only 24 VDC is available for manifolds compatible with serial wiring.

3 Common specification

Nil	Positive common
N	Negative common

* For the non-polar type, there is no need to select a symbol.
 * When the standard valve and valve with a switch are used on a manifold compatible with the serial transmission system, select a common specification that matches the SI unit common specification.

4 Connector entry

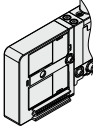
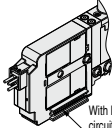
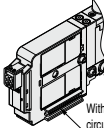
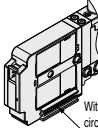
C: Dedicated for centralized wiring 	M: Individual wiring, With lead wire Length 300 mm  With linkage-printed circuit board	MN: Individual wiring, Without lead wire (With connector, socket)  With linkage-printed circuit board	MO: Individual wiring, Without connector  With linkage-printed circuit board
---	--	--	---

* Connector entries with the symbol "M□" cannot use the switch signal from the common wiring on the manifold.
 * When ordering a connector assembly separately, refer to pages 383 and 384.

5 Light/surge voltage suppressor

U	With light/surge voltage suppressor (Non-polar type)
Z	With light/surge voltage suppressor (Polar type)

* When the types with power-saving circuit, with switches, and individual wiring are used, the non-polar type cannot be selected.

6 With switch

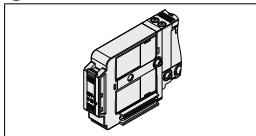

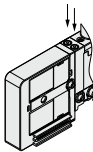
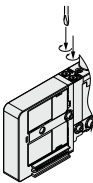

7 Manual override

Nil: Non-locking push type 	D: Push-turn locking slotted type 
--	--



* No slide locking type manual override setting is provided.

8 Needle operation

Nil: Manual 	D: Slotted locking type 
---	---

* Set operation torque to 0.3 N·m or less.

9 PS port for detection

Nil: M5 x 0.8 	P: With plug (M-5P) 
---	---

* When mounting a pressure sensor, etc., select "Nil."

* There is no valve lock switch for linking the neighboring valve, etc., to the 3-position 3-port solenoid valve with restrictor. Please contact SMC if you wish to use the SJ1000/2000/3000 valve with a valve lock switch, or an end block or SUP/EXH block assembly.

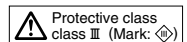

Plug-in Cable Type



RoHS

Vacuum Release Valve with Restrictor

SJ3A6 Series

An order cannot be placed with only the manifold part no. Be sure to order solenoid valves for mounting at the same time while referring to the ordering example.

How to Order

● Vacuum release valve manifold with restrictor

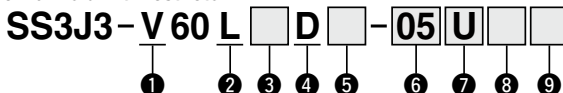

1 Vacuum release valve with restrictor type

2 Cable type

5 Connector entry

With parallel wiring specifications, it is necessary to select the connector entry direction (1: upward, 2: lateral). For details, refer to page 292.

3 Connector type

Symbol	Mounting position	Page	Note
F	D-sub connector	292	Parallel wiring
P	Flat ribbon cable 26 pins		
PG	Flat ribbon cable 20 pins		
PH	Flat ribbon cable 10 pins		

4 Connector mounting position

Symbol	Mounting position
D	D side

6 Valve stations

F: D-sub connector

Symbol	Stations
02	2 stations
⋮	⋮
10	10 stations

P: Flat ribbon cable (26 pins)

Symbol	Stations
02	2 stations
⋮	⋮
10	10 stations

PG: Flat ribbon cable (20 pins)

Symbol	Stations
02	2 stations
⋮	⋮
09	9 stations

PH: Flat ribbon cable (10 pins)

Symbol	Stations
02	2 stations
⋮	⋮
04	4 stations

* This number also includes the blanking block assembly.
* The cable type is only applicable when there are 2 or more stations.

7 SUP/EXH block mounting position

Symbol	Mounting position
U	U side
D	D side
B	Both sides
M ^{*1}	Special specifications

*1 For the special specifications, a part size of the SUP/EXH block assembly can be specified. At this time, the mounting position becomes only U, D, or B.

8 SUP/EXH block fitting specification

Nil		L		B	
Straight fitting X, PE port: Elbow fitting		Elbow fitting (Upward) X, PE port: Straight fitting		Elbow fitting (Downward) X, PE port: Elbow fitting	

* There is no need to enter anything when the SUP/EXH block mounting position "M" is selected. Also, this manifold comes standard with external pilot specifications.

9 DIN rail length specified

Nil	Standard length	
3	3 stations	Specify a length longer than that of the standard rail.
⋮	⋮	⋮
10	10 stations	the standard rail.

* When specifying a length longer than that of the standard rail, select the number of valve stations without exceeding the max. number of stations.

How to Order Manifold Assembly

Ordering example (SS3J3-V60LPD2-□)

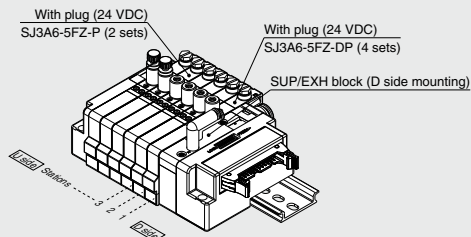

SS3J3-V60LPD2-06D1 set (Manifold part no.)
* SJ3A6-5FZ-DP4 sets (With plug part no.)
* SJ3A6-5FZ-P2 sets (With plug part no.)
The asterisk denotes the symbol for the assembly.
Prefix it to the part numbers of the solenoid valve, etc.

· For the valve arrangement, the valve closest to the D side is considered the 1st station.
· Under the manifold part number, state the valves to be mounted in order starting with the 1st station as shown in the figure. If the arrangement becomes too complicated, specify the details on a manifold specification sheet.

How to Order Solenoid Valves (3-Position 3-Port with Restrictor)

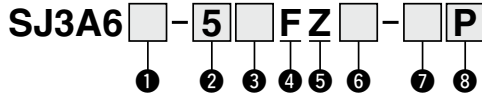

1 Coil type

Nil	Standard
T	With power-saving circuit (Continuous duty type)

* Be sure to select the power-saving circuit type if the valve is to be continuously energized for long periods of time.

2 Rated voltage

5	24 VDC
6	12 VDC

3 Common specification

Nil	Positive common
N	Negative common

4 Connector entry

F: Dedicated for centralized wiring
Cable type

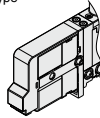

5 Light/surge voltage suppressor

Z With light/surge voltage suppressor

6 Manual override

Nil: Non-locking push type

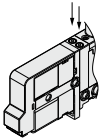

D: Push-turn locking slotted type

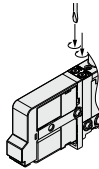

* No slide locking type manual override setting is provided.

7 Needle operation

Nil: Manual



D: Slotted locking type



* Set operation torque to 0.3 N·m or less.

8 PS port for detection

Nil: M5 x 0.8



P: With plug (M-5P)



* When mounting a pressure sensor, etc., select "Nil."

* There is no valve lock switch for the 3-position 3-port solenoid valve with restrictor.

SJ3A6 Series

Dimensions

SS3J3-V60^{P=D}_{FD}¹ - Stations U/D/B

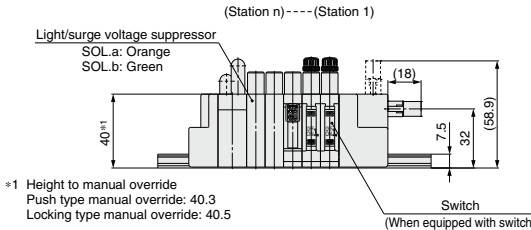
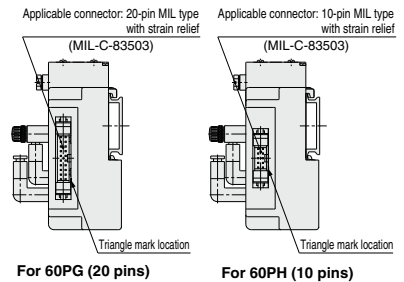
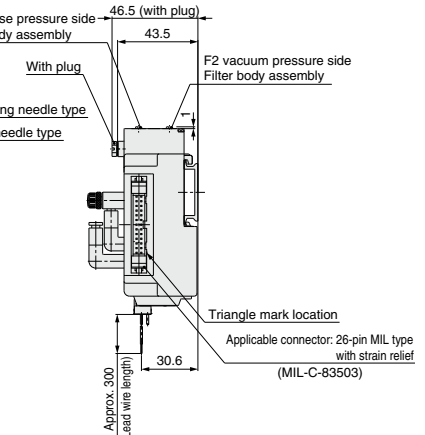
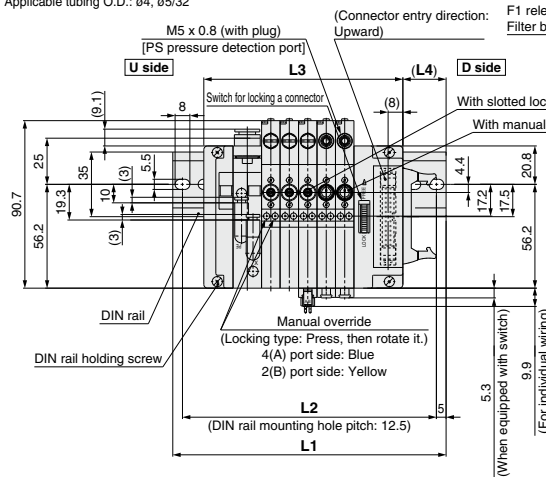
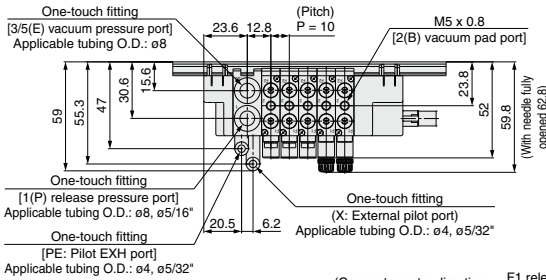

Since DIN rail dimensions are the same as the SS5J3-60□ series, refer to the following pages.
For D-sub connector: p. 300, 301
For flat ribbon cable: p. 307, 308
For EX180 serial wiring: p. 318, 319
For EX510 serial wiring: p. 328, 329

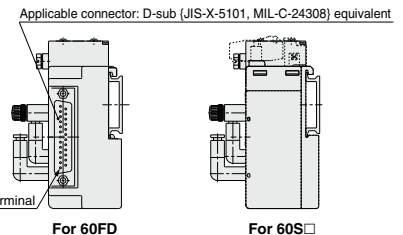
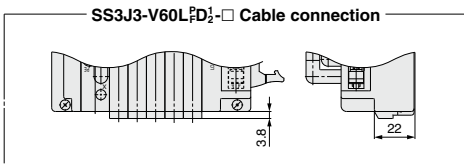

Non Plug-in Individual Wiring



Vacuum Release Valve with Restrictor



SJ3A6 Series

An order cannot be placed with only the manifold part no. Be sure to order solenoid valves for mounting at the same time while referring to the ordering example.

How to Order

Individual wiring manifold

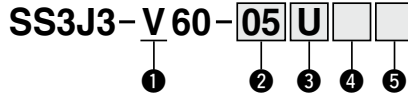

1 Vacuum release valve with restrictor type

2 Valve stations

Symbol	Stations
01	1 station
⋮	⋮
20	20 stations

* This number also includes the blanking block assembly.

3 SUP/EXH block mounting position

U	U side
D	D side
B	Both sides
M ^{*1}	Special specifications

*1 Specify the required specifications (including port sizes other than ø8) on the manifold specification sheet.

4 SUP/EXH block fitting specification

Nil	L	B
Straight fitting X, PE port: Elbow fitting	Elbow fitting (Upward) X, PE port: Straight fitting	Elbow fitting (Downward) X, PE port: Elbow fitting

* There is no need to enter anything when the SUP/EXH block mounting position "M" is selected. Also, this manifold comes standard with external pilot specifications.

5 DIN rail length specified

Nil	Standard length
2	2 stations
⋮	⋮
20	10 stations

* Specify the number of valve stations without exceeding the max. number of stations.

How to Order Manifold Assembly

Ordering example (SS3J3-V60-□)

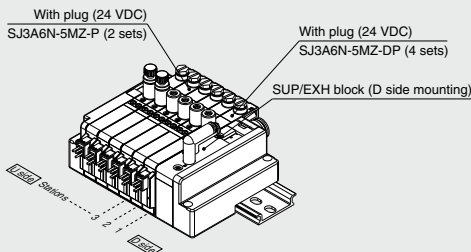

SS3J3-V60-06D 1 set (Manifold part no.)

* SJ3A6N-5MZ-DP 4 sets (With plug part no.)

* SJ3A6N-5MZ-P 2 sets (With plug part no.)

—The asterisk denotes the symbol for the assembly. Prefix it to the part numbers of the solenoid valve, etc.

• For the valve arrangement, the valve closest to the D side is considered the 1st station.

• Under the manifold part number, state the valves to be mounted in order starting with the 1st station as shown in the figure. If the arrangement becomes too complicated, specify the details on a manifold specification sheet.

How to Order Solenoid Valves (3-Position 3-Port with Restrictor)

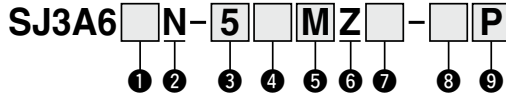

1 Coil type

Nil	Standard
T	With power-saving circuit (Continuous duty type)

* Be sure to select the power-saving circuit type if the valve is to be continuously energized for long periods of time.

2 For non plug-in only

3 Rated voltage

5	24 VDC
6	12 VDC

4 Common specification

Nil	Positive common
N	Negative common

5 Connector entry

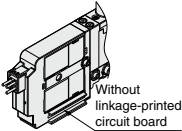
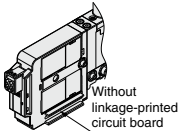
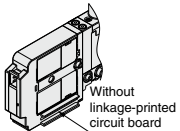
<p>M: Individual wiring, With lead wire Length 300 mm</p>  <p>Without linkage-printed circuit board</p>	<p>MN: Individual wiring, Without lead wire (With connector, socket)</p>  <p>Without linkage-printed circuit board</p>	<p>MO: Individual wiring, Without connector</p>  <p>Without linkage-printed circuit board</p>
---	--	---

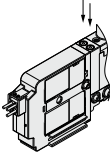
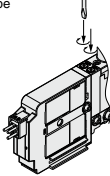

* When ordering a connector assembly separately, refer to pages 383 and 384.

7 Manual override

<p>Nil: Non-locking push type</p> 	<p>D: Push-turn locking slotted type</p> 
---	--



* No slide locking type manual override setting is provided.

8 Needle operation

<p>Nil: Manual</p> 	<p>D: Slotted locking type</p> 
---	---

* Set operation torque to 0.3 N·m or less.

9 PS port for detection

<p>Nil: M5 x 0.8</p> 	<p>P: With plug (M-5P)</p> 
---	--

* When mounting a pressure sensor, etc., select "Nil."

SJ3A6 Series

Dimensions

SS5J3-V60- Stations U/D/B

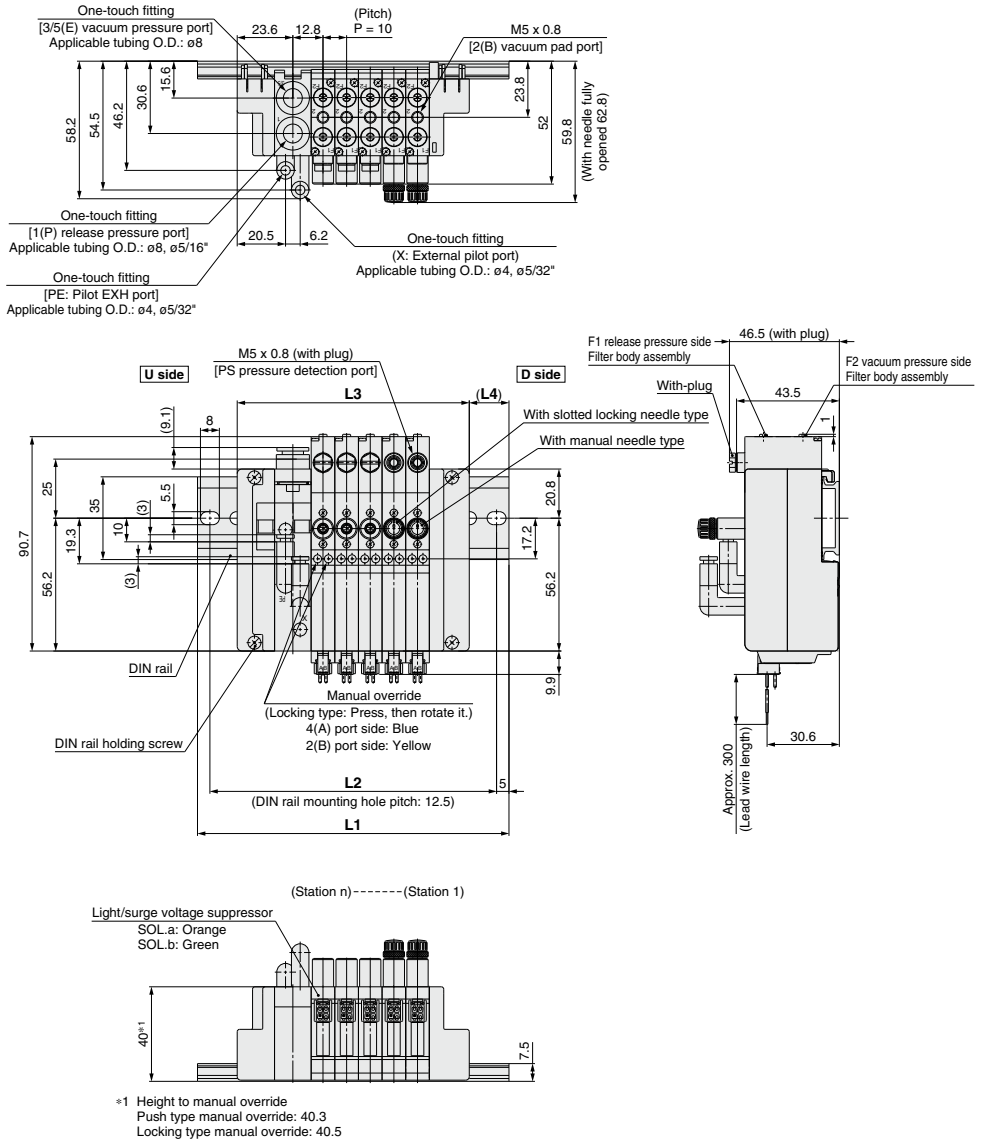

Since DIN rail dimensions are the same as the SS5J3-60-□ series, refer to pages 340 and 341.

SJ3A6 Series

Manifold Exploded View

Connector Type/Individual Wiring

Type V60P (Vacuum release valve with restrictor) manifold

* Refer to page 333 for "How to Increase Manifold Stations."

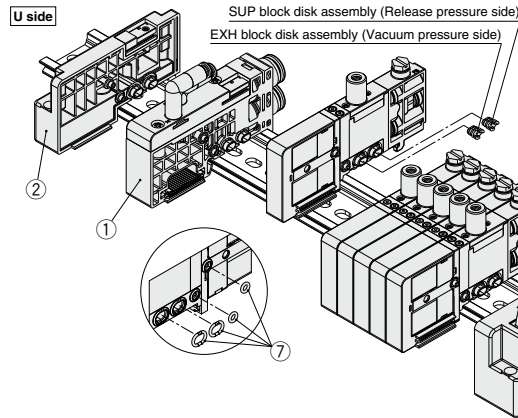

Type V60S (Plug-in, EX180 Integrated type (for output) serial transmission system) manifold

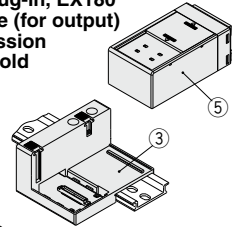

Non plug-in (Individual wiring)

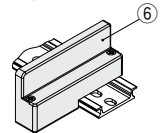

Component Parts: Plug-in (Connector Type)

No.	Description	Part no.	Note
1*1	External pilot	SJ3000-50-1AR-□□-N (X, PE port: Metric size ø4 Inch size ø5/32")	(Metric size) C6: With ø6 One-touch fitting (straight) C8: With ø8 One-touch fitting (straight) L6: With ø6 One-touch fitting (elbow upward entry) L8: With ø8 One-touch fitting (elbow upward entry) B6: With ø6 One-touch fitting (elbow downward entry) B8: With ø8 One-touch fitting (elbow downward entry)
	For different pressures*2	SJ3000-50-3A-□□-N	(Inch size) N7: With 1/4" One-touch fitting (straight) N9: With 5/16" One-touch fitting (straight)
2*1	End block assembly	SJ3000-53-1A-N	For the U side
3	Connector block assembly	SJ3000-42-□□-□	Refer to the connector block assembly part nos. shown below.
4	DIN rail	VZ1000-11-1-□	Refer to page 346.
5	SI unit	EX180-□□	Refer to the SI unit part nos. on page 312.
7	O-ring for valve connection*3	SJ3000-96-1A	The part no. shown on the left includes parts for 5 units. (10 pcs. each for the P and E ports and for the X and PE ports)

Connector Block Assembly Part Nos.

Connector specifications	Mounting position	Part no.	Note
For D-sub connector (Locking bracket: Metric size thread)	D side	SJ3000-42-1A-□	□: 1 (Connector upward) □: 2 (Connector lateral)
For D-sub connector (Locking bracket: Unified thread)		SJ3000-42-1AU-□	
For flat ribbon cable 26 pins		SJ3000-42-2A-□	
For flat ribbon cable 20 pins		SJ3000-42-3A-□	
For flat ribbon cable 10 pins		SJ3000-42-4A-□	
For EX180 serial wiring*4		SJ3000-42-20A	
For EX510 serial wiring*4		SJ3000-42-3A-2	

*4 An SI unit is not included.

Component Parts: Non plug-in (Individual Wiring)

No.	Description	Part no.	Note
1*1	External pilot	SJ3000-50-5AR-□□-N (X, PE port: Metric size ø4 Inch size ø5/32")	(Metric size) C6: With ø6 One-touch fitting (straight) C8: With ø8 One-touch fitting (straight) L6: With ø6 One-touch fitting (elbow upward entry) L8: With ø8 One-touch fitting (elbow upward entry) B6: With ø6 One-touch fitting (elbow downward entry) B8: With ø8 One-touch fitting (elbow downward entry)
	For different pressures*2	SJ3000-50-6A-□□-N	(Inch size) N7: With 1/4" One-touch fitting (straight) N9: With 5/16" One-touch fitting (straight)
2*1	End block assembly	SJ3000-53-1A-N	For the U side
4	DIN rail	VZ1000-11-1-□	Refer to page 346.
6	End block assembly	SJ3000-53-2A	For the D side
7	O-ring for valve connection*3	SJ3000-96-1A	The part no. shown on the left includes parts for 5 units. (10 pcs. each for the P and E ports and for the X and PE ports)

*1 For the SJ3A6 series, valve lock and manual switches are not available.

*2 As the valves cannot be operated only with the SUP/EXH block assembly for different pressures, select them in combination with the SUP/EXH block assembly for external pilot.

*3 Included with valves, SUP/EXH block assemblies, and connector block assemblies

*4 Refer to page 344 for the SUP/EXH block disk assembly and method of handling parts at different pressures.

SJ3A6 Series

Cable Type

Type V60LP (Vacuum release valve with restrictor) manifold

* Refer to page 334 for "How to Increase Manifold Stations."

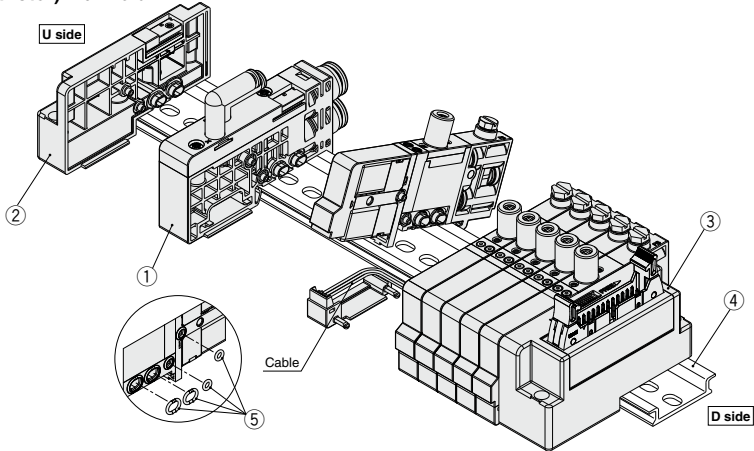

Component Parts: Plug-in (Cable Type)

No.	Description	Part no.	Note
1*	External pilot	SJ3000-50-5AR-□□-N (X, PE port: Metric size ø4 Inch size ø5/32")	(Metric size) C6: With ø6 One-touch fitting (straight) C8: With ø8 One-touch fitting (straight) L6: With ø6 One-touch fitting (elbow upward entry) L8: With ø8 One-touch fitting (elbow upward entry) B6: With ø6 One-touch fitting (elbow downward entry) B8: With ø8 One-touch fitting (elbow downward entry)
	For different pressures*2	SJ3000-50-6A-□□-N	(Inch size) N7: 1/4" One-touch fitting (straight) N9: 5/16" One-touch fitting (straight)
2*1	End block assembly	SJ3000-53-1A-N	
3	Connector block assembly	SJ3000-42-□A-□	Refer to the connector block assembly part nos. shown below.
4	DIN rail	VZ1000-11-1-□	Refer to page 346.
5	O-ring for valve connection*3	SJ3000-96-1A	The part no. shown on the left includes parts for 5 units. (10 pcs. each for the P and E ports and for the X and PE ports)

*1 For the SJ3A6 series, valve lock and manual switches are not available.

*2 As the valves cannot be operated only with the SUP/EXH block assembly for different pressures, select them in combination with the SUP/EXH block assembly for external pilot.

*3 Included with valves, SUP/EXH block assemblies, and connector block assemblies.

* Refer to page 344 for the SUP/EXH block disk assembly and method of handling parts at different pressures.

●Connector Block Assembly

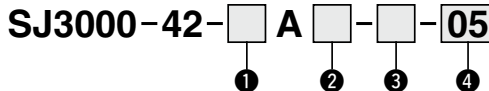

1 Connector type

7	D-sub connector
8	Flat ribbon cable 26 pins
9	Flat ribbon cable 20 pins
10	Flat ribbon cable 10 pins

* All connector block assembly mounting positions are on the D side.

* The connector block assembly includes the cables necessary for the number of stations.

2 Locking bracket

Nil	Metric size thread
U	Unified thread

* D-sub connector only

3 Connector entry direction

1	Upward
2	Lateral

4 Valve stations

02 to 10	D-sub connector
02 to 10	Flat ribbon cable 26 pins
02 to 09	Flat ribbon cable 20 pins
02 to 04	Flat ribbon cable 10 pins

Specific Product Precautions 1

Be sure to read this before handling the products. Refer to page 7 for safety instructions and pages 8 to 14 for 3/4/5 port solenoid valve precautions.



Manual Override Switch Operation

Warning

For manual override operation, move the manual override switch to a position where letters A and B can be seen. [Manual override switch release status (refer to the figure below)] Operation with the manual override switch in a locked status can cause damage to the manual override and air leakage, so be sure to release the manual override switch before use. After manual override operation, lock the manual switch for use (when the manual override of the push-turn locking slotted type is locked, a manual override switch cannot be locked).



Manual override switch locked status



Manual override switch unlocked status

Manual override switch slide direction

Manual Override Operation

Warning

When the manual override is operated, connected equipment will be actuated. Confirm safety before operating.

Non-locking push type

Press in the direction of the arrow.

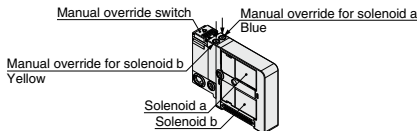

Push-turn locking slotted type

While pressing, turn in the direction of the arrow (90° clockwise). If it is not turned, it can be used in the same way as the non-locking push type.

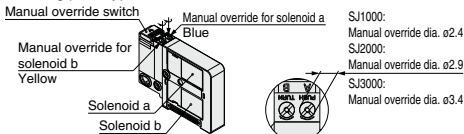

SJ1000: Manual override dia. ø2.4
 SJ2000: Manual override dia. ø2.9
 SJ3000: Manual override dia. ø3.4

Slide locking type (manual override)

Slide the manual override all the way to the ON side in the arrow direction. The manual override of the D type, be sure to push it before the manual override, slide it toward the OFF side in the arrow direction.

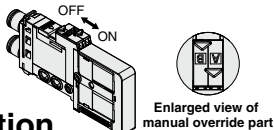

Caution

When you operate the D type with a screw driver, turn it gently using a watchmaker's screw driver. [Torque: under 0.05 N·m] When you lock the manual override of the D type, be sure to push it before turning. [Load: 10 N or less] Turning without pushing can cause damage to the manual override and trouble such as air leakage, etc.

Valve with Switch

Warning

When turning OFF the valve using the switch, move it to the position where the valve is locked. If the switch is at an improper position and is energized, equipment connected to the valve could be actuated.

Also, if the switch is turned OFF on the valve in the energized state, be careful because any actuators connected to a single solenoid, a dual 3-port valve, or a 3-position valve will actuate.

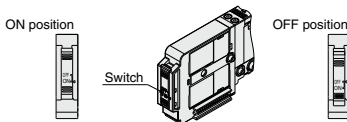

Normal operation: The valve is switched according to electric signals from the connector on the manifold side.

The valve coil is kept in a deenergized state even when there is an electric signal from the connector on the manifold side.

Electric circuit diagram

(with positive common and light/surge voltage suppressor)

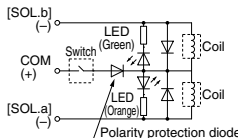

(with negative common and light/surge voltage suppressor)

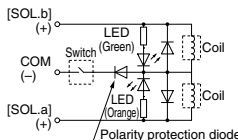

Built-in Back Pressure Check Valve Type

Caution

1. Valves with built-in back pressure check valve is to protect the back pressure inside a valve. For this reason, use caution the valves with external pilot specification cannot be pressurized from exhaust port [3/5(E)].

As compared with the types which do not integrate the back pressure check valve, C value of the flow rate characteristics (sonic conductance) goes down. For details, please contact SMC.

2. Do not switch valves when A or B port is open to the atmosphere, or while the actuators and air operated equipment are in operation. The back pressure prevention seal may be peeled off, which may cause air leakage or malfunctions. Use caution especially when performing a trial operation or maintenance work.

Exhaust Throttle

Caution

The SJ series pilot valve and main valve share a common exhaust inside the valve. Therefore, do not block the exhaust port when arranging the piping.

Specific Product Precautions 2

Be sure to read this before handling the products. Refer to page 7 for safety instructions and pages 8 to 14 for 3/4/5 port solenoid valve precautions.



Used as a 3-Port Valve

⚠ Caution

■When using a 4-port valve as a 3-port valve

The SJ1000/2000/3000 series can be used as normally closed (N.C.) or normally open (N.O.) 3-port valves by closing one of the cylinder ports 4(A) or 2(B) with a plug. However, they should be used with the exhaust ports kept open. They are convenient at times when a double solenoid type 3-port valve is required.

Plug position Type of actuation	2(B) port N.C.	4(A) port N.O.
Single		
Double		

Light/Surge Voltage Suppressor

⚠ Caution

■Non-polar type Single solenoid

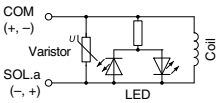

Double solenoid, 3-position type

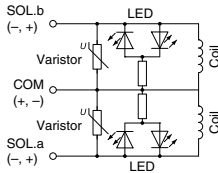

■Positive common Single solenoid

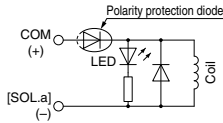

Double solenoid, 3-position type

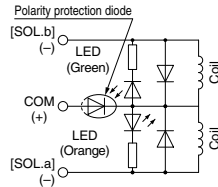

■Negative common Single solenoid

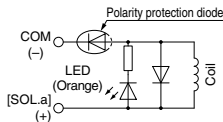

Double solenoid, 3-position type

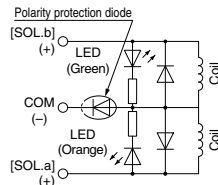

Continuous Duty

⚠ Caution

If a valve is energized continuously for long periods of time, the rise in temperature due to heat-up of the coil assembly may cause a decline in solenoid valve performance, reduce the service life, or have adverse effects on peripheral equipment. In particular, if three or more adjacent stations on the manifold are energized simultaneously for extended periods of time or if the valves on A side and B side are energized simultaneously for long periods of time, take special care as the temperature rise will be greater.

If it is possible to select a valve with a power-saving circuit, be sure to do so.

If the continuously energized time exceeds three hours, please contact SMC.

■With power-saving circuit

Power consumption is decreased to approx. 1/3 (for SJ3□60T) compared with the standard model by reducing the wattage required to hold the valve in an energized state. (Effective energizing time is over 67 ms at 24 VDC.)

Electric circuit diagram (with power-saving circuit)

In case of positive common, single solenoid

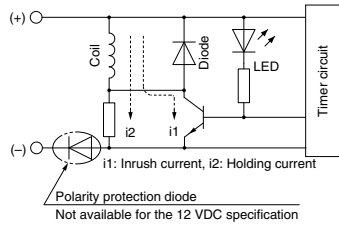

In case of negative common, single solenoid

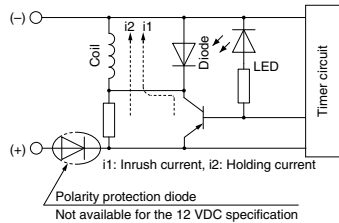

UL Approved Product

⚠ Caution

When conformity to UL is required, the product should be used with a UL1310 Class 2 power supply.

The product is a UL approved product only if it has a mark on the body.

Specific Product Precautions 3

Be sure to read this before handling the products. Refer to page 7 for safety instructions and pages 8 to 14 for 3/4/5 port solenoid valve precautions.



Working Principle

The circuit shown on page 380 reduces the power consumption for holding in order to save energy. Refer to the electrical power waveform as shown below.

Electrical power waveform of the power-saving type (SJ3□60T)

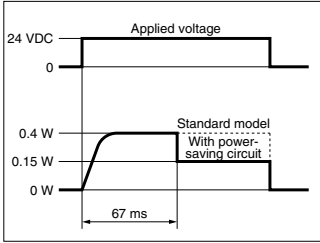

Electrical power waveform of the power-saving type (SJ1□60T, SJ2□60T)

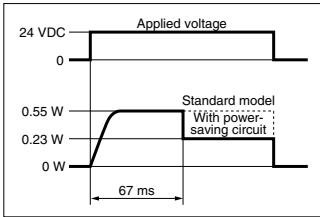

- The 12 VDC specification with power-saving circuit does not have the polarity protection diode. Do not make a mistake with the polarity.
- Since the voltage will drop by approx. 0.5 V due to the transistor, pay attention to the allowable voltage fluctuation. (For details, refer to the solenoid specifications of each type of valve.)

Countermeasure for Surge Voltage Intrusion

■ Surge voltage intrusion

With non-polar type valves, at times of sudden interruption of the loading power supply, such as emergency shutdown, surge voltage intrusion may be generated from loading equipment with a large capacity (power consumption), and a valve in a de-energized state may switch over (see Fig. 1). When installing a breaker circuit for the loading power supply, consider using a valve with polarity (with polarity protection diode), or install a surge absorption diode between the loading equipment COM line and the output equipment COM line (see Fig. 2).

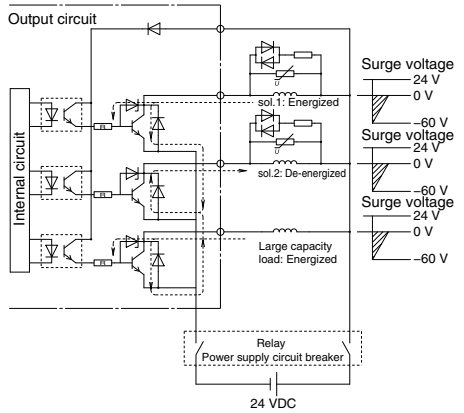

Fig. 1 Surge intrusion circuit example (NPN outlet example) (24 VDC)

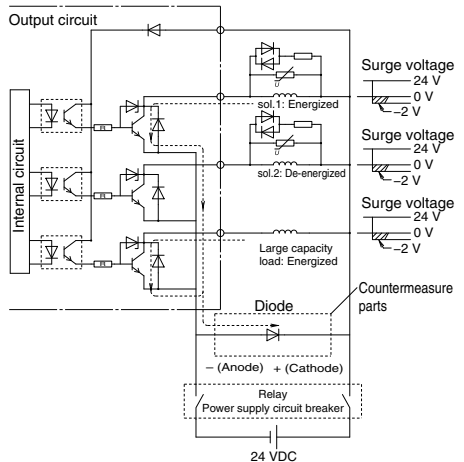

Fig. 2 Surge intrusion countermeasure example (NPN outlet example) (24 VDC)

Specific Product Precautions 4

Be sure to read this before handling the products. Refer to page 7 for safety instructions and pages 8 to 14 for 3/4/5 port solenoid valve precautions.



Light Indication

⚠ Caution

When equipped with light/surge voltage suppressor, the light window turns orange when solenoid a is energized, and it turns green when solenoid b is energized.

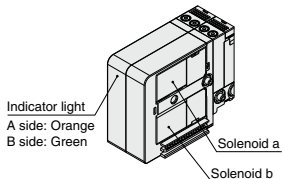

Changing the Connector Entry Direction

⚠ Caution

To change the connector's entry direction, set the switch on the top of the connector block to the FREE position, before turning the connector. Make sure to set the switch back to the LOCK position before connecting the connector. (When the switch is difficult to slide, move the connector a little so that it will slide easier.) If an excessive force is applied on the connector in the LOCK position, the connector block may be damaged. Also, using in such a way that the connector floats in the FREE position, it may cause the lead wire, etc., to break. Thus, refrain from using in these ways.

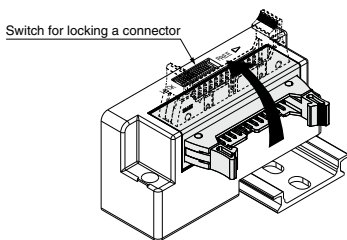

Manifold Mounting

When attaching a manifold to a mounting surface, etc., with bolts, if the entire bottom surface of the DIN rail contacts the mounting surface in a horizontal mounting, it can be used by simply securing both ends of the DIN rail. However, for any other mounting method or for side facing and rear facing, etc., secure the DIN rail with bolts at uniform intervals using the following as a guide: 2 to 5 stations at 2 locations, 6 to 10 stations at 3 locations, 11 to 15 stations at 4 locations, 16 to 20 stations at 5 locations, 21 to 25 stations at 6 locations, 26 to 30 stations at 7 locations, and more than 30 stations at 8 locations.

In addition, even in the case of a horizontal mounting, if the mounting surface is subject to vibration, etc., take the same measures indicated above. If secured at fewer than the specified number of locations, warping or twisting may occur in the DIN rail and manifold, causing trouble such as air leakage.

Specific Product Precautions 5

Be sure to read this before handling the products. Refer to page 7 for safety instructions and pages 8 to 14 for 3/4/5 port solenoid valve precautions.



Fitting Replacement

⚠ Caution

By replacing a valve's fitting assembly, it is possible to change the port size of the 4(A), 2(B), 1(P), and 3/5(E) ports. When replacing it, pull out the fitting assembly after removing the clip with a flat blade screw driver, etc. To mount a new fitting assembly, insert it into place and then fully reinsert the clip.

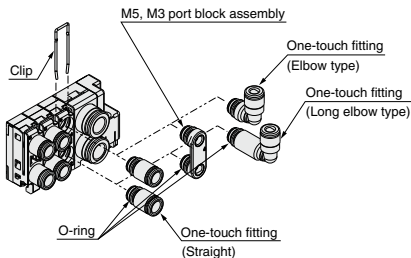

Fitting Assembly Part Nos.

Metric Size

Port	Port size	Part no.
SJ1000 4(A), 2(B)	ø2 One-touch fitting (Straight)	KQSY10-C2
	ø4 One-touch fitting (Straight)	KQSY10-C4-X1336
SJ2000 4(A) 2(B)	ø2 One-touch fitting (Straight)	KJH02-C1
	ø4 One-touch fitting (Straight)	KJH04-C1
	ø2 One-touch fitting (Elbow type)	KJL02-C1
	ø4 One-touch fitting (Elbow type)	KJL04-C1-N
	ø2 One-touch fitting (Long elbow type)	KJW02-C1
	ø4 One-touch fitting (Long elbow type)	KJW04-C1-N
SJ3000 4(A) 2(B)	M3 port block assembly	SJ2000-56-1A
	ø2 One-touch fitting (Straight)	KJH02-C2
	ø4 One-touch fitting (Straight)	KJH04-C2
	ø6 One-touch fitting (Straight)	KJH06-C2
	ø2 One-touch fitting (Elbow type)	KJL02-C2
	ø4 One-touch fitting (Elbow type)	KJL04-C2
	ø6 One-touch fitting (Elbow type)	KJL06-C2-N
	ø2 One-touch fitting (Long elbow type)	KJW02-C2
	ø4 One-touch fitting (Long elbow type)	KJW04-C2
	ø6 One-touch fitting (Long elbow type)	KJW06-C2-N
1(P) 3/5(E)	M5 port block assembly	SJ3000-56-1A
	ø6 One-touch fitting (Straight)	VVQ1000-51A-C6
	ø6 One-touch fitting (Elbow type)	SZ3000-74-1A-L6
	ø6 One-touch fitting (Long elbow type)	SZ3000-74-2A-L6
	ø8 One-touch fitting (Straight)	VVQ1000-51A-C8
ø8 One-touch fitting (Elbow type)	SZ3000-74-1A-L8	
	ø8 One-touch fitting (Long elbow type)	SZ3000-74-2A-L8

Inch Size

Port	Port size	Part no.
SJ2000 4(A) 2(B)	ø1/8" One-touch fitting (Straight)	KJH01-C1
	ø5/32" One-touch fitting (Straight)	KJH03-C1
	ø1/8" One-touch fitting (Elbow type)	KJL01-C1
	ø5/32" One-touch fitting (Elbow type)	KJL03-C1
	ø1/8" One-touch fitting (Long elbow type)	KJW01-C1
	ø5/32" One-touch fitting (Long elbow type)	KJW03-C1
SJ3000 4(A) 2(B)	ø1/8" One-touch fitting (Straight)	KJH01-C2
	ø5/32" One-touch fitting (Straight)	KJH03-C2
	ø1/4" One-touch fitting (Straight)	KJH07-C2
	ø1/8" One-touch fitting (Elbow type)	KJL01-C2
	ø5/32" One-touch fitting (Elbow type)	KJL03-C2
	ø1/4" One-touch fitting (Elbow type)	KJL07-C2
	ø1/8" One-touch fitting (Long elbow type)	KJW01-C2
ø5/32" One-touch fitting (Long elbow type)	KJW03-C2	
	ø1/4" One-touch fitting (Long elbow type)	KJW07-C2
	1(P) 3/5(E)	ø1/4" One-touch fitting (Straight)
ø5/16" One-touch fitting (Straight)	VVQ1000-51A-N9	

* To change the port size of the 1(P), 3/5(E) ports into the port sizes other than ø8 (straight), specify the change on the manifold specification sheet.

* Be careful to avoid damage or contamination to the O-rings, as this can cause air leakage.

* When removing a straight-type fitting from a valve, after removing the clip, attach tubing or a plug (KJP-02, KQ2P-□) to the One-touch fitting, and pull it out while holding the tubing or plug. If it is pulled out while holding the release button of the fitting (resin part), the release button may be damaged.

* Be sure to turn off the power and stop the supply of air before disassembly. Furthermore, since air may remain inside the actuator, piping, and manifold, confirm that the air is completely exhausted before starting any work.

* While inserting a tubing into an elbow-type fitting, hold the main body of the fitting by hand. Failure to do so will exert an undue force on the valve or the fitting, resulting in air leakage or damage.

* Each fitting assembly part no. contains 1 pc. Additionally, when the piping is constructed in the same direction using the elbow-type fitting, order the elbow-type and/or long elbow-type fitting.

Clip Part Nos.

Part no.			Note
SJ1000	SJ2000	SJ3000	
SJ1000-CL-1	SJ2000-CL-1	SJ3000-CL-1	These part numbers contain 10 pcs. each.

Specific Product Precautions 6

Be sure to read this before handling the products. Refer to page 7 for safety instructions and pages 8 to 14 for 3/4/5 port solenoid valve precautions.



One-touch Fittings

⚠ Caution

The pitch of the SJ series piping ports (A, B, etc.) has been set assuming the use of KJ series One-touch fittings. Therefore, when using fittings with an M3 or M5 port block assembly, there may be some interference between fittings, depending on the type and size, so please use after checking dimensions in the catalog for the pipe fitting being used.

1. Tube attachment/detachment for One-touch fittings

1) Tube attachment

- Take a tube having no flaws on its periphery and cut it off at a right angle. When cutting the tube, use tube cutters TK-1, 2, or 3. Do not use pinchers, nippers, scissors, etc. If cutting is done with tools other than tube cutters, the tube may be cut diagonally or become flattened, etc., making a secure installation impossible, and causing problems such as the tube pulling out after installation or air leakage.

Allow some extra length in the tube.

- Grasp the tube and push it in slowly, inserting it securely all the way into the fitting.
- After inserting the tube, pull on it lightly to confirm that it will not come out. If it is not installed securely all the way into the fitting, this can cause problems such as air leakage or the tube pulling out.

2) Tube detachment

- The 4(A) and 2(B) ports use the KJ series, so the tube can be removed by pressing on part of the release button. However, for the 1(P) and 3/5(E) ports, please press the release button evenly as before.
- Pull out the tube while holding down the release button so that it does not come out. If the release button is not pressed down sufficiently, there will be increased bite on the tube and it will become more difficult to pull it out.
- When the removed tube is to be used again, cut off the portion which has been chewed before reusing it. If the chewed portion of the tube is used as is, this can cause trouble such as air leakage or difficulty in removing the tube.

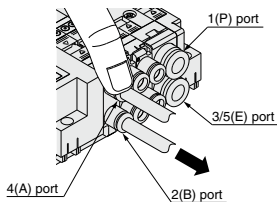

Hold down part of the release button with your finger or a similar tool, as shown in the diagram, and pull out in the direction indicated by the arrow.

Other Tube Brands

⚠ Caution

1. When using other than SMC brand tube, confirm that the following specifications are satisfied with respect to the tube outside diameter tolerance.

- Nylon tube within ± 0.1 mm
- Soft nylon tube within ± 0.1 mm
- Polyurethane tube within $+0.15$ mm, within -0.2 mm

Do not use tube which does not meet these outside diameter tolerances. It may not be possible to connect them, or they may cause other trouble, such as air leakage or the tube pulling out after connection.

How to Use Plug Connector

⚠ Caution

When attaching and detaching a connector, first shut off the electric power and the air supply.

Also, crimp the lead wires and sockets securely.

1. Connector attachment/detachment

- To attach a connector, hold the lever and connector unit between your fingers and insert straight onto the pins of the solenoid valve so that the lever's pawl is pushed into the groove and locks.
- To detach a connector, remove the pawl from the groove by pushing the lever downward with your thumb, and pull the connector straight out.

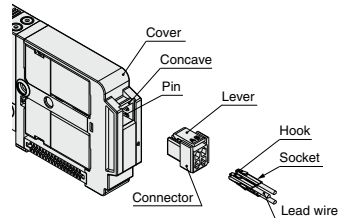

2. Crimping of lead wires and sockets

Peel 3.2 to 3.7 mm of the tip of the lead wire, enter the core wires neatly into a socket and crimp it with a special crimping tool. Be careful so that the cover of the lead wire does not enter into the crimping part. (Please contact SMC for the dedicated crimping tools.)

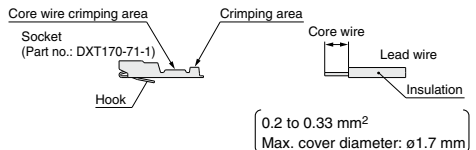



SJ1000/2000/3000 Series

Specific Product Precautions 7

Be sure to read this before handling the products. Refer to page 7 for safety instructions and pages 8 to 14 for 3/4/5 port solenoid valve precautions.

How to Use Plug Connector

⚠ Caution

3. Lead wires with sockets attachment/detachment

• Attachment

Insert the sockets into the square holes of the connector (with A, B, C, and N indication), and continue to push the sockets all the way in until they lock by hooking into the seats in the connector. (When they are pushed in, their hooks open, and they are locked automatically.) Next, confirm that they are locked by pulling lightly on the lead wires.

• Detachment

To detach a socket from a connector, pull out the lead wire while pressing the socket's hook with a stick having a thin tip (approx. 1 mm). If the socket is used again, spread the hook outward.

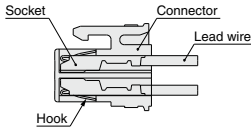

<Positive common>

Single solenoid

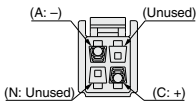

Double solenoid

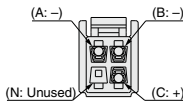

<Negative common>

Single solenoid

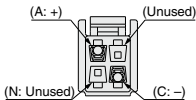

Double solenoid

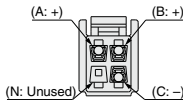

Plug Connector Lead Wire Length

⚠ Caution

Plug connector lead wires have a standard length of 300 mm, however, the following lengths are also available.

Connector Assembly Part Nos.

Single solenoid

SJ3000-46-S-□ (for positive common)

SJ3000-47-S-□ (for negative common)

Double solenoid, 3-position type, 4-position type

SJ3000-46-D-□ (for positive common)

SJ3000-47-D-□ (for negative common)

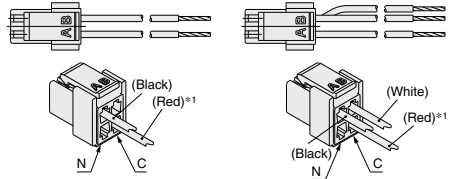

*1 In case of negative common, the lead wire changes from red to yellow.

For single solenoid:

Lead wire length	Part No.	Lead wire length
Nil	SJ3000-46-S-□	300 mm
6		600 mm
10		1000 mm
15		1500 mm
20		2000 mm
25		2500 mm
30		3000 mm
50		5000 mm

For double solenoid

For 3-position type :

For 4-position type

Common specifications

46	For positive common
47	For negative common

For single solenoid

Without lead wire: SJ3000-46-S-N (positive/negative common)

(Connector, Socket x 2 pcs. only)

For double solenoid

Without lead wire: SJ3000-46-D-N (positive/negative common)

(Connector, Socket x 3 pcs. only)

How to Order

Include the connector assembly part number together with the part number for the plug connector's solenoid valve without connector.

(Example) In case of lead wire length 2000 mm and positive common

SJ3160-5MOZ-C6

SJ3000-46-S-20

Connector Assembly for Manifolds (for Junction Common)

⚠ Caution

Using the connector assembly (for junction common) for solenoid valves installed in the manifold reduces the labor involved in wiring work because common wiring for all solenoid valves is integrated into a single wire.

SJ1000/2000/3000 Series

Specific Product Precautions 8



Be sure to read this before handling the products. Refer to page 7 for safety instructions and pages 8 to 14 for 3/4/5 port solenoid valve precautions.

Connector Assembly Part Nos. (for Junction Common)

Single solenoid

SJ3000-46-SC-□ (for positive common)

SJ3000-47-SC-□ (for negative common)

Double solenoid,
3-position type, 4-position type

SJ3000-46-DC-□ (for positive common)

SJ3000-47-DC-□ (for negative common)

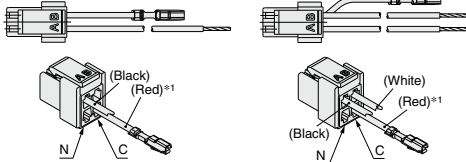

*1 In case of negative common, the lead wire changes from red to yellow.

For single solenoid:

SJ3000-46-SC-□

For double solenoid

SJ3000-46-DC-□

For 3-position type :

SJ3000-46-DC-□

For 4-position type

Common specifications

46 For positive common

47 For negative common

● Lead wire length

Nil	300 mm
6	600 mm
10	1000 mm
15	1500 mm
20	2000 mm
25	2500 mm
30	3000 mm
50	5000 mm

● For junction common

How to Order

Indicate the part no. of the connector assembly for the manifold and solenoid valve.

If the arrangement is too complicated, please specify the details on a manifold specification sheet.

- * Applications like connectors not wired to a valve are not possible.
- * For the solenoid valve, please designate "No connector (MOZ)" for the connector type.
- * Connector assembly with lead wire for place where the signals are transmitted to the common wiring. (Only the valves of the first station and/or last station of the manifold are compatible to connector with lead wire for common.)

(Example)

- SS5J3-60-04U 1 set
- * SJ3160N-5MOZ-C6 ... 2 sets
- * SJ3260N-5MOZ-C6 ... 2 sets
- * SJ3000-46-S 1 set (Connector assembly for single solenoid)
- * SJ3000-46-SC 1 set (Connector assembly for single solenoid) (for junction common)
- * SJ3000-46-DC 2 sets (Connector assembly for double solenoid) (for junction common)

The asterisk denotes the symbol for the assembly.
Prefix it to the part nos. of the solenoid valve, etc.

Wiring Instructions for Connector Assembly (for Junction Common)

Caution

If only connector assembly (for junction common) is ordered, please wire according to the instructions in the diagram below. For details on socket mounting, please refer to "How to Use Plug Connector" on page 382.

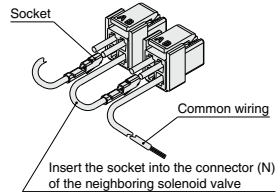



SJ1000/2000/3000 Series

Specific Product Precautions 9

Be sure to read this before handling the products. Refer to page 7 for safety instructions and pages 8 to 14 for 3/4/5 port solenoid valve precautions.

One-touch Fittings

⚠ Caution

When fittings are used, they may interfere with one another depending on their types and sizes. Therefore, the dimensions of the fittings to be used should first be confirmed in their respective catalogs. Fittings whose compliance with the SJ series is already confirmed are stated below. If the fitting within the applicable range is selected, there will not be any interference.

Applicable Fittings: KQ2H, KQ2S Series KJH, KJS Series

Series	Model	Piping port	Port size	Fitting	Applicable tubing O.D.			
					ø2	ø3.2	ø4	ø6
SJ3000 (10 mm pitch)	SJ3□60-□□-M5	4A, 2B	M5	KQ2H KJH	[Shaded bar]			
				KQ2S KJS	[Shaded bar]			
SJ2000 (7.5 mm pitch)	SJ2□60-□□-M3	4A, 2B	M3	KQ2H KJH	[Shaded bar]			
				KQ2S KJS	[Shaded bar]			
SJ3A6 (10 mm pitch)	SJ3A6-□□	2B	M5	KQ2H KJH	[Shaded bar]			
				KQ2S KJS	[Shaded bar]			