

# Dual Rod Cylinder

## CXSJ/CXS Series

ø6, ø10, ø15, ø20, ø25, ø32

### Dual rod cylinder with guide function suitable for pick & place applications.



Ball bushing bearings and slide bearings are standard for all series.

Dimensions for ball bushing bearings and slide bearings are the same.

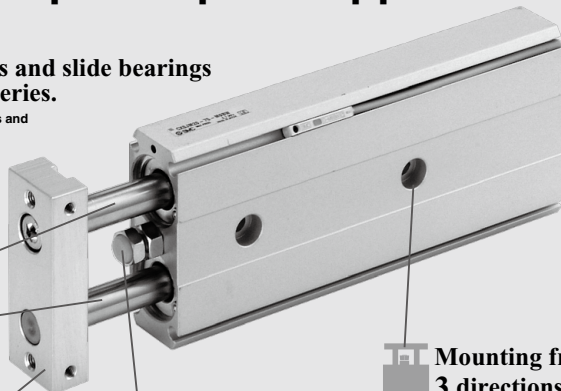

Twice the thrust  
Non-rotating  
accuracy  $\pm 0.1^\circ$



Adjustable stroke  
range:  
0 to -5 mm



Work can be mounted  
on three faces.

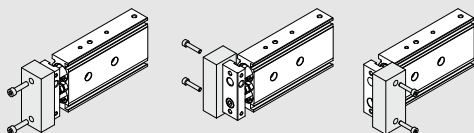

Mounting from  
3 directions.

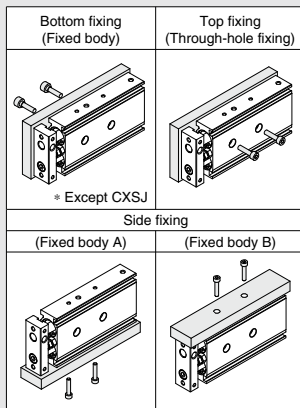

#### Series Variations

Series	Bore size (mm)						Axial foot piping	Clean Series			Cylinder with Stable Lubrication Function (Lube-retainer)	Page
	6	10	15	20	25	32		10-	11-	12-		
Compact type	CXSJ	●	●	●	●	●	(ø6, ø10 only)	●	●	●		P.737
Basic type	CXS	●	●	●	●	●	(ø6 only)	●	●	●		P.749
With air cushion	CXS	●	●	●	●	●		●	●	●		P.761
With end lock	CXS	●	●	●	●	●		●	●	●		P.768
Double rod type	CXSW	●	●	●	●	●		●	●	●		P.775

CX2

CXW

CXT

CXSJ

CXS

D-□

-X□

# Compact Type

# CXSJ Series

- Auto switch can be installed from 3 directions.

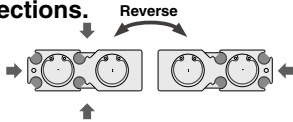

- Symmetric mounting

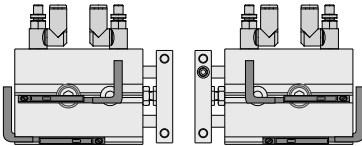

### Reverse mounting mechanism

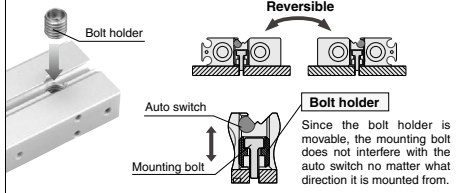

- Dimensions/Weight

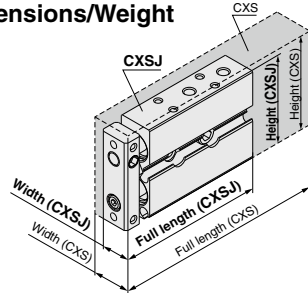

Bore size (mm)	Series	Dimensions (mm)			Note Weight (kg)
		Width	Height	Full length	
ø6	CXSJ□6	13.4	32	42 + Stroke	0.057
	CXS□6	16	37	58.5 + Stroke	0.095
ø10	CXSJ□10	15	42	56 + Stroke	0.114
	CXS□10	17	46	72 + Stroke	0.170
ø15	CXSJ□15	19	54	70 + Stroke	0.219
	CXS□15	20	58	79 + Stroke	0.280
ø20	CXSJ□20	24	62	84 + Stroke	0.371
	CXS□20	25	64	94 + Stroke	0.440
ø25	CXSJ□25	29	73	87 + Stroke	0.544
	CXS□25	30	80	96 + Stroke	0.660
ø32	CXSJ□32	37	94	100.5 + Stroke	1.078
	CXS□32	38	98	112 + Stroke	1.230

Note) Slide bearing, 20 mm strokes

- Axial piping available (ø6, ø10)

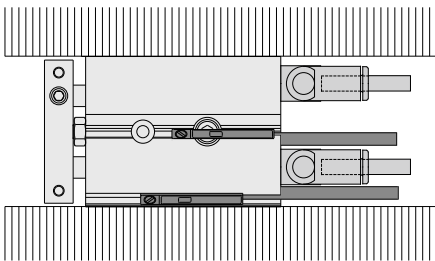

- Allowable kinetic energy, allowable load, and non-rotating accuracy are equivalent to those of CXS basic type.

# With air cushion

CXS Series:  $\varnothing 20$ ,  $\varnothing 25$ ,  $\varnothing 32$

**Air cushion only minimally adds to full length dimension, compared with the standard type cylinder.**

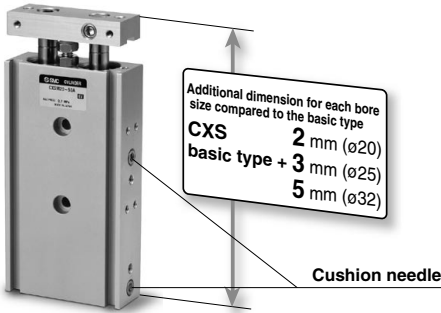

- 1 Improved allowable kinetic energy:  
**Two to three times that of the standard type**
- 2 Improved noise reduction:  
**Reduction of more than 6 dB is possible**

## Unique air cushion mechanism with no cushion ring

Elimination of the cushion ring used in current type air cushions has made it possible to reduce the overall length of the cylinder while retaining all the advantages of a compact profile.

### Working principle

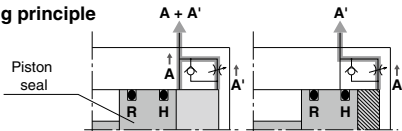

1. When the piston is retracting, air is exhausted through both A and A' until piston seal H passes air passage A.
2. After piston seal H has passed air passage A, air is exhausted only through A'. The section marked with slanted lines becomes a cushion chamber, and an air cushion effect is achieved.
3. When air is supplied for the piston extension, the check seal opens and the piston extends with no delay.



## Clean Series

11- CXSJ Series/ $\varnothing 6$ ,  $\varnothing 10$   
12-

Series	Type	Bearing type
11-CXSJ	Vacuum specifications	Slide bearing Ball bushing bearing
12-CXSJ	Relieving type Special treatment	Ball bushing bearing

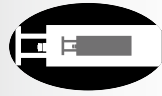

P.737

### Compact type

CXSJ Series

$\varnothing 6$ ,  $\varnothing 10$ ,  $\varnothing 15$ ,  $\varnothing 20$ ,  $\varnothing 25$ ,  $\varnothing 32$



P.749

### Basic type

CXS Series

$\varnothing 6$ ,  $\varnothing 10$ ,  $\varnothing 15$ ,  $\varnothing 20$ ,  $\varnothing 25$ ,  $\varnothing 32$

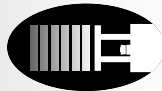

P.761

### With air cushion

CXS Series

$\varnothing 20$ ,  $\varnothing 25$ ,  $\varnothing 32$



P.768

### With end lock

CXS Series

$\varnothing 6$ ,  $\varnothing 10$ ,  $\varnothing 15$ ,  $\varnothing 20$ ,  $\varnothing 25$ ,  $\varnothing 32$



P.775

### Double rod type

CXSW Series

$\varnothing 6$ ,  $\varnothing 10$ ,  $\varnothing 15$ ,  $\varnothing 20$ ,  $\varnothing 25$ ,  $\varnothing 32$



CX2

CXW

CXT

CXSJ

CXS

D-□

-X□

# CXSJ Series Model Selection

**⚠ Caution** Theoretical output must be confirmed separately, referring to the table on page 738.

## Model Selection

### Vertical Mounting

Mounting orientation					
	Up to 200		Up to 400		
Max. speed (mm/s)	Up to 200		Up to 400		
Stroke (mm)	All strokes				
Selection graph	ø6	1	2	3	4
	ø10				
	ø15				
	ø20				
	ø25				
	ø32				

### Horizontal Mounting

Mounting orientation											
	* Refer to the caution notes below.										
Stroke (mm)	Up to 10		Up to 30		Up to 50		Up to 75		Up to 100		
Max. speed (mm/s)	Up to 400	Over 400	Up to 400	Over 400	Up to 400	Over 400	Up to 400	Over 400	Up to 400	Over 400	
Selection graph	ø6	5		6		7		14		15	
	ø10										
	ø15	8	9	10	11	12	13				
	ø20										
	ø25										
	ø32										

\* The maximum speeds for ø6 to ø32 are: ø6, 10: up to 800 mm/s; ø15, 20: up to 700 mm/s; ø25, 32: up to 600 mm/s

## ⚠ Caution

If the cylinder is horizontally mounted and the plate end does not reach the load's center of gravity, use the formula below to calculate the imaginary stroke  $L'$  that includes the distance between the load's center of gravity and the plate end. Select the graph that corresponds to the imaginary stroke  $L'$ .

Imaginary stroke  $L' = (\text{Stroke}) + k + L$

k: Distance between the center and end of the plate

ø6	2.75 mm
ø10	4 mm
ø15	5 mm
ø20	6 mm
ø25	
ø32	8 mm

(Example)

① When using CXSJM6-10 and  $L = 15$  mm:

Imaginary stroke  $L' = 10 + 2.75 + 15 = 27.75$   
Therefore, the graph used for your model selection should be the one for CXSJM6-30(⑤).

② When using CXSJL25-50 and  $L = 10$  mm:

Imaginary stroke  $L' = 50 + 6 + 15 = 71$   
Therefore, the graph used for your model selection should be the one for CXSJL25-75(⑭).



**Vertical Mounting**

**Graph (1) V = 200 (mm/s)**

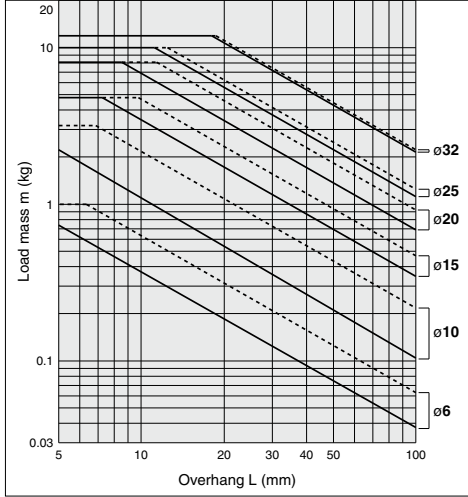

**Graph (2) V = 400 (mm/s)**

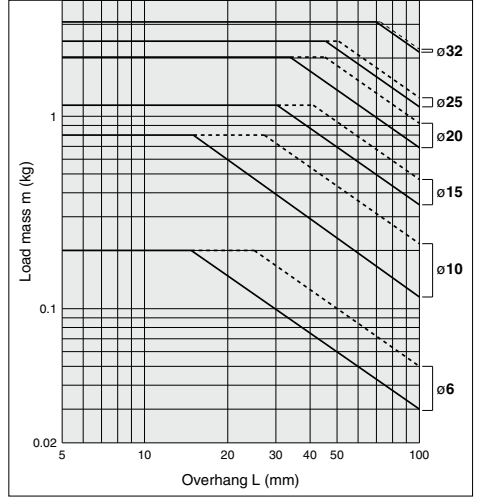

**Graph (3) V = 600 (mm/s)**

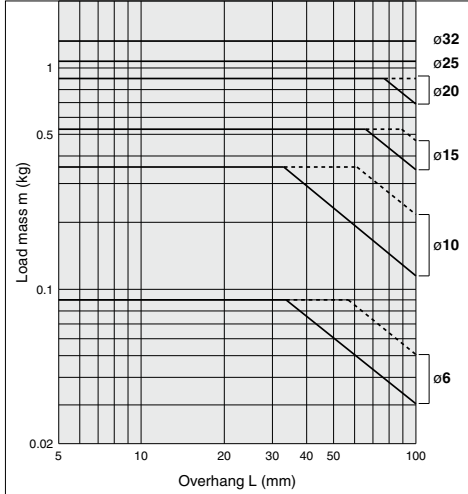

**Graph (4) V = 800 (mm/s)  
(V = 700 mm/s for ø15, 20)**

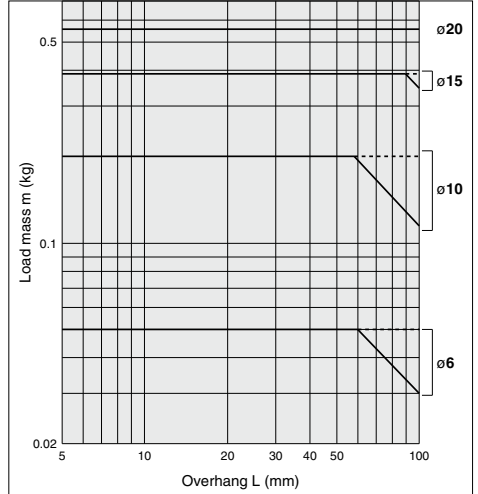

Note) V = 700 mm/s for ø15, ø20.

**CX2**

**CXW**

**CXT**

**CXSJ**

**CXS**

**D-□**

**-X□**

## Horizontal Mounting

**Graph (5) Up to 10 mm stroke**      - - - - - V = Up to 400 mm/s  
 - - - - - V = Up to 800 mm/s

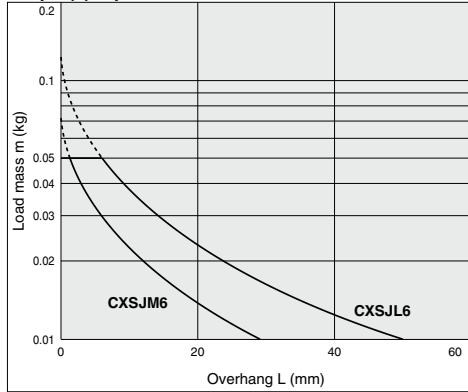

**Graph (6) Up to 30 mm stroke**      - - - - - V = Up to 400 mm/s  
 - - - - - V = Up to 800 mm/s

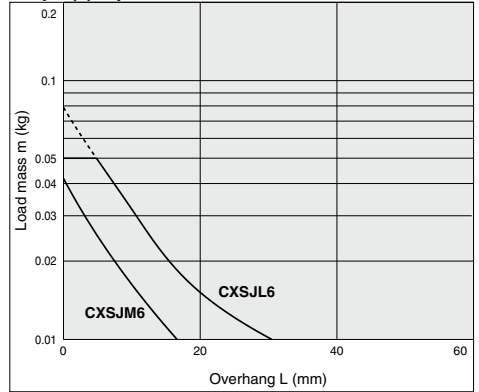

**Graph (8) V = Up to 400 mm/s; Up to 10 mm stroke**      - - - - - CXSJM  
 - - - - - CXS JL

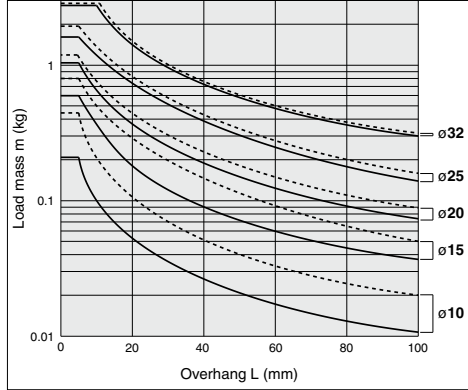

**Graph (9) V = Over 400 mm/s; Up to 10 mm stroke**      - - - - - CXSJM  
 - - - - - CXS JL

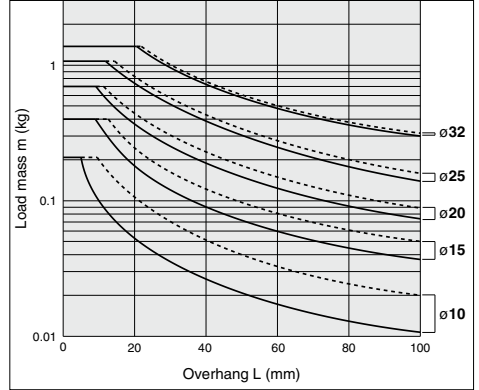

**Graph (12) V = Up to 400 mm/s; Up to 50 mm stroke**      - - - - - CXSJM  
 - - - - - CXS JL

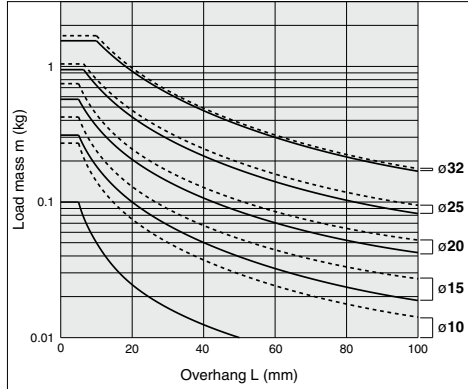

**Graph (13) V = Over 400 mm/s; Up to 50 mm stroke**      - - - - - CXSJM  
 - - - - - CXS JL

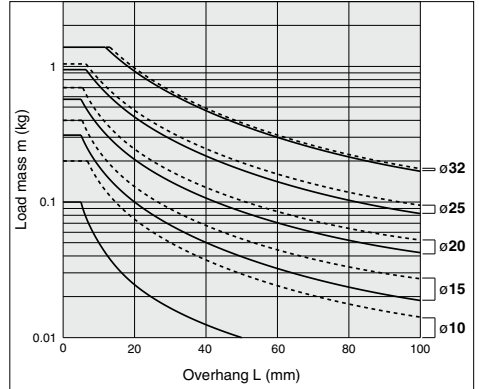

**Graph (7) Up to 50 mm stroke** ——— V = Up to 800mm/s

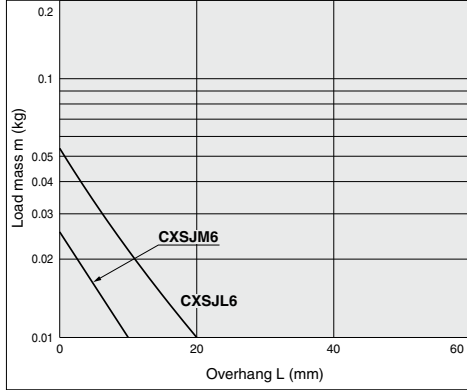

**Graph (10) V = Up to 400 mm/s; Up to 30 mm stroke** ——— CXSJM  
----- CXSJL

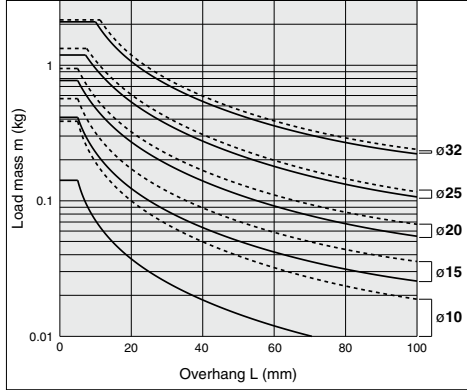

**Graph (11) V = Over 400 mm/s; Up to 30 mm stroke** ——— CXSJM  
----- CXSJL

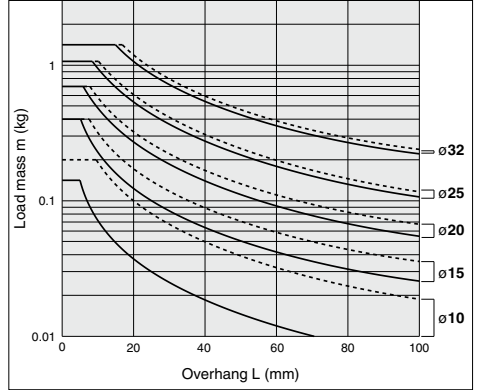

**Graph (14) V = Over 400 mm/s; Up to 75 mm stroke** ——— CXSJM  
----- CXSJL

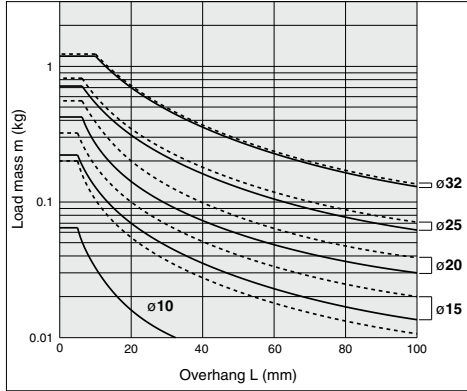

**Graph (15) V = Over 400 mm/s; Up to 100 mm stroke** ——— CXSJM  
----- CXSJL

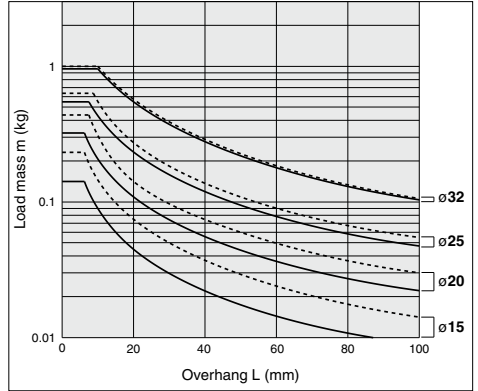

- CX2
- CXW
- CXT
- CXSJ
- CXS

- D-
- X

# CXS Series

## Model Selection/Basic Type

**⚠ Caution** Confirmation of theoretical output is required separately.  
Refer to "Theoretical Output" on page 750.

### Basic Type: CXS

#### Vertical Mounting

Mounting orientation							
	Max. speed (mm/s)	Up to 100	Up to 200	Up to 300	Up to 400	Up to 600	Up to 700 (Up to 800)
Stroke (mm)	All strokes						
Selection graph	⌀6	(1)		(2)			
	⌀10						
	⌀15						
	⌀20		(3)		(4)	(5)	(6)
	⌀32						

#### Horizontal Mounting

Mounting orientation													
	* Refer to the caution notes below.												
Stroke (mm)	Up to 10		Up to 30		Up to 50		Up to 75		Up to 100				
Max. speed (mm/s)	Up to 100	Up to 300	Up to 400	Over 400	Up to 100	Up to 300	Up to 400	Over 400	Up to 100	Up to 300	Up to 400	Over 400	
Selection graph	⌀6	(7)			(8)				(9)				
	⌀10												
	⌀15												
	⌀20		(10)	(11)		(12)	(13)		(14)	(15)		(16)	
	⌀25												
⌀32												(17)	

\* The maximum speeds for ⌀10 to ⌀32 are: ⌀10: up to 800 mm/s; ⌀15, 20: up to 700 mm/s; ⌀25, 32: Up to 600 mm/s

### ⚠ Caution

If the cylinder is horizontally mounted and the plate end does not reach the load's center of gravity, use the formula below to calculate the imaginary stroke L' that includes the distance between the load's center of gravity and the plate end. Select the graph that corresponds to the imaginary stroke L'.

Imaginary stroke L' = (Stroke) + k + L

k: Distance between the center and end of the plate

⌀6	2.75 mm
⌀10	4 mm
⌀15	5 mm
⌀20	6 mm
⌀25	
⌀32	8 mm

(Example)

When using CXSM6-10 and L = 15 mm:

Imaginary stroke L' = 10 + 2.75 + 15 = 27.75

Therefore, the graph used for your model selection should be the one for CXSM6-30.

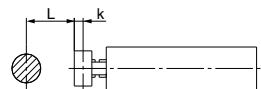



**Vertical Mounting**

**ø6**

**Graph (1) V=100(mm/s)**

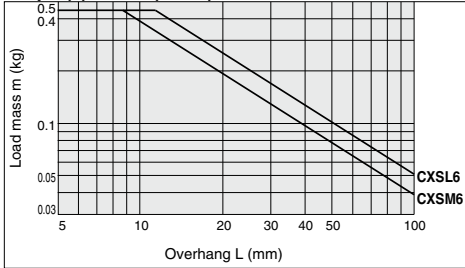

**Graph (2) V=300(mm/s)**

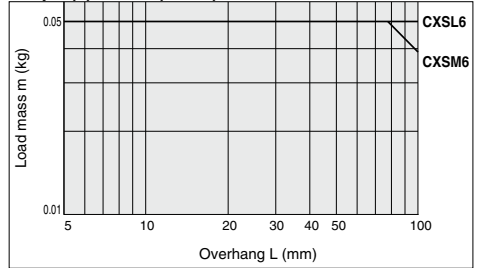

**ø10 to ø32**

**Graph (3) V=200(mm/s)**

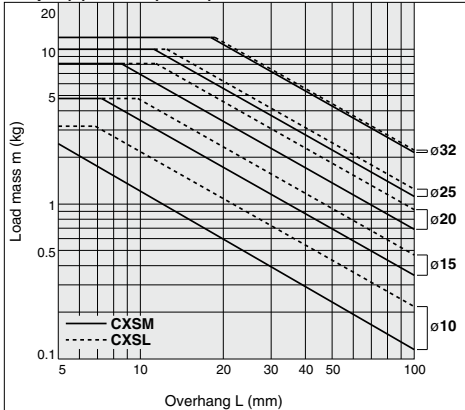

**Graph (4) V=400(mm/s)**

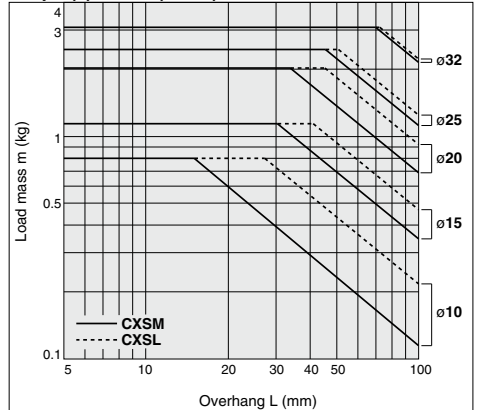

**Graph (5) V=600(mm/s)**

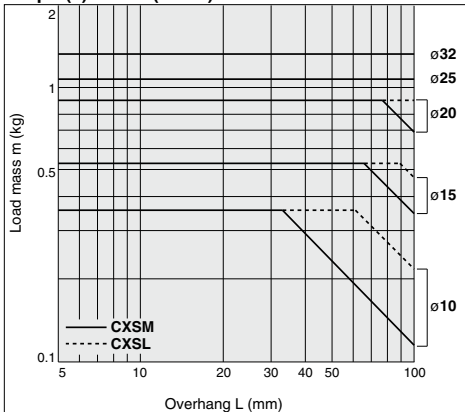

**Graph (6) V=700(mm/s) (800 mm/s for ø10)**

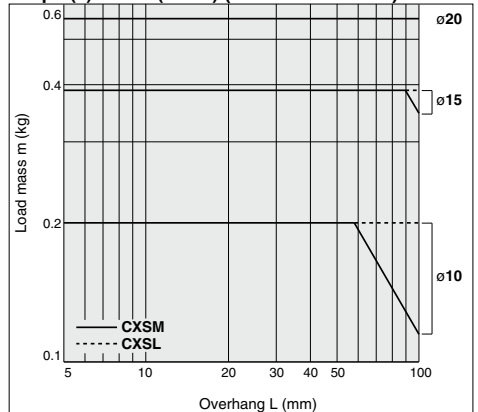

- CX2
- CXW
- CXT
- CXSJ
- CXS**

- D-
- X

# CXS Series

## Horizontal Mounting

ø6

Graph (7) Up to 10 st

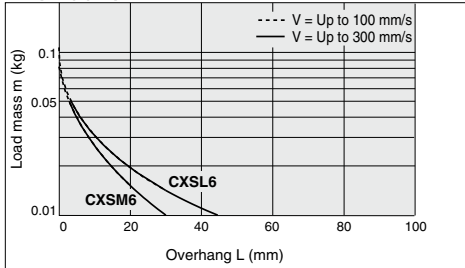

Graph (8) Up to 30 st

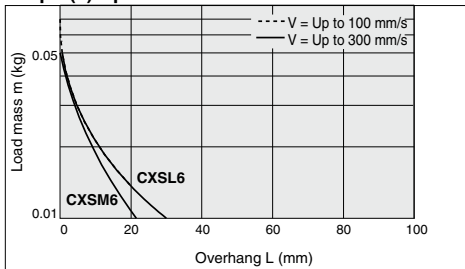

Graph (9) Up to 50 st

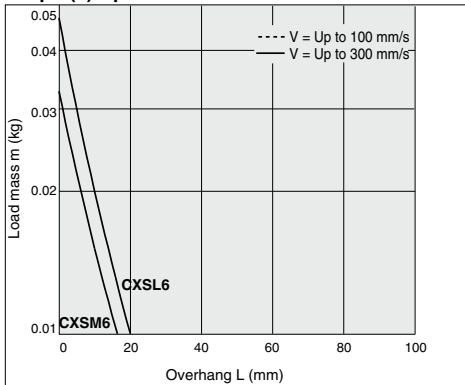

ø10 to ø32

Graph (10) V = Up to 400 mm/s; Up to 10 st

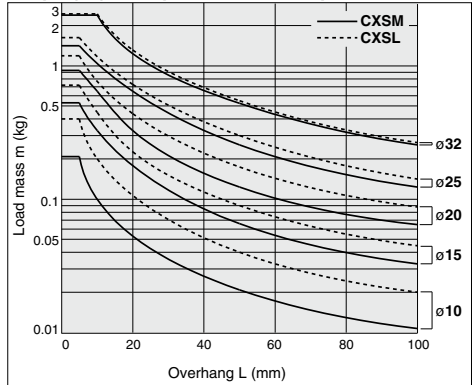

Graph (11) V = Over 400 mm/s; Up to 10 st

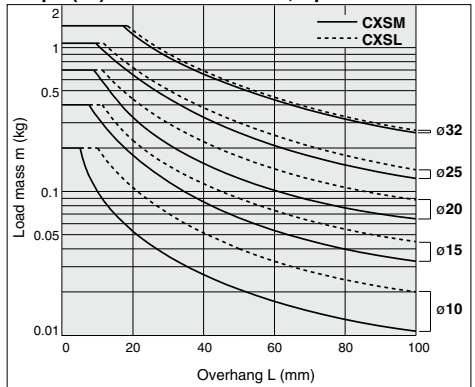

Graph (12) V = Up to 400 mm/s; Up to 30 st

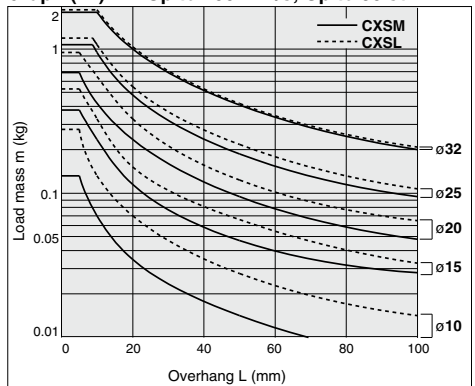

**Horizontal Mounting**

**ø10 to ø32**

**Graph (13) V = Over 400 mm/s; Up to 30 st**

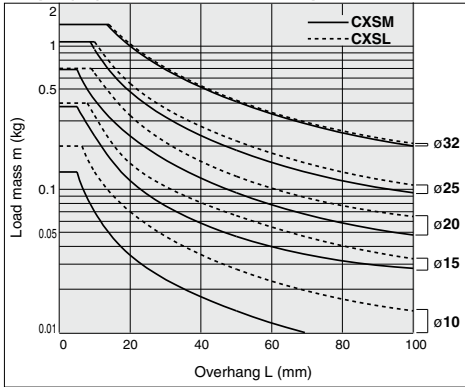

**Graph (14) V = Up to 400 mm/s; Up to 50 st**

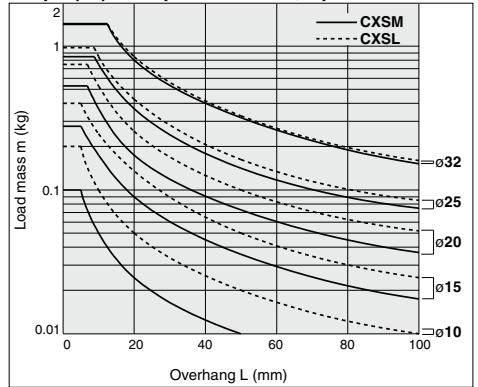

**Graph (15) V = Over 400 mm/s; Up to 50 st**

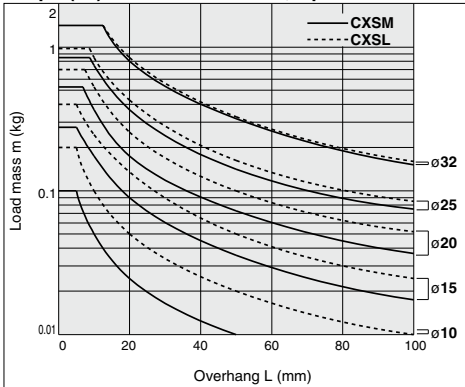

**Graph (16) V = Over 400 mm/s; Up to 75 st**

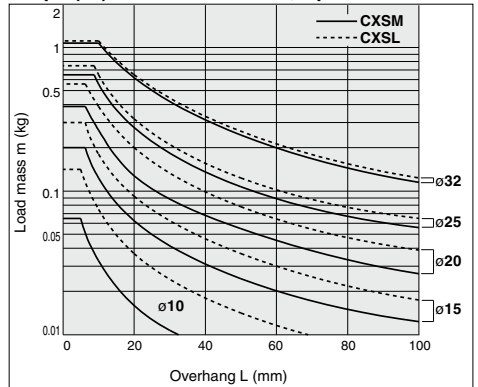

**Graph (17) V = Over 400 mm/s; Up to 100 st**

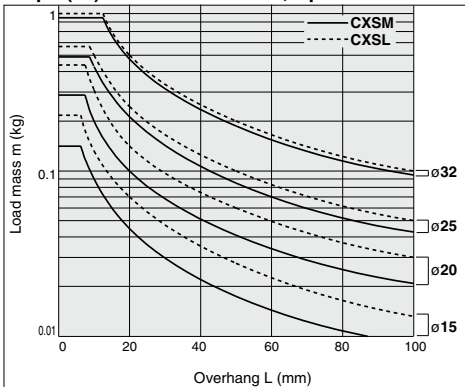

**CX2**

**CXW**

**CXT**

**CXSJ**

**CXS**

**D-□**

**-X□**

# CXS Series

## Model Selection/With Air Cushion

**⚠ Caution** Confirmation of theoretical output is required separately. Refer to “Theoretical Output Table” on page 762.

### With Air Cushion: CXS

#### Vertical Mounting

Mounting orientation						
Max. speed (mm/s)	Up to 200	Up to 400	Up to 600	Up to 800	Up to 1000	
Stroke (mm)	All strokes					
Selection graph	ø20	(1)	(2)	(3)	(4)	(5)
	ø25					
	ø32					

#### Horizontal Mounting

Mounting orientation								
Stroke (mm)	Up to 10		Up to 30		Up to 50	Up to 75	Up to 100	
Max. speed (mm/s)	Up to 800	Up to 1000	Up to 800	Up to 1000	Up to 1000	Up to 1000	Up to 1000	
Selection graph	ø20	(6)	(7)	(8)	(9)	(10)	(11)	(12)
	ø25							
	ø32							

### ⚠ Caution

If the cylinder is horizontally mounted and the plate end does not reach the load's center of gravity, use the formula below to calculate the imaginary stroke  $L'$  that includes the distance between the load's center of gravity and the plate end. Select the graph that corresponds to the imaginary stroke  $L'$ .

Imaginary stroke  $L' = (\text{Stroke}) + k + L$

k: Distance between the center and the end of the plate

ø20	6 mm
ø25	
ø32	

(Example)

When using CXSM20-10 and  $L = 10$  mm:

Imaginary stroke  $L' = 10 + 6 + 10 = 26$

Therefore, the graph used for your model selection should be the one for CXSM20-30.

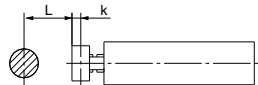

**Vertical Mounting**

**Graph (1) V = 200 mm/s**

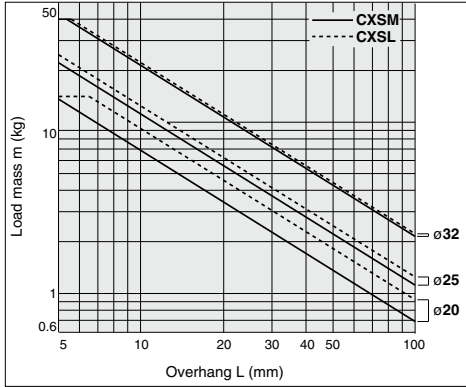

**Graph (2) V = 400 mm/s**

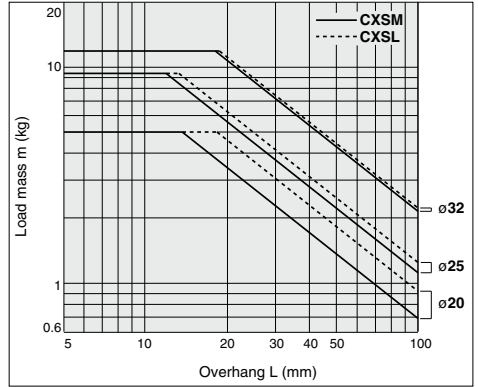

**Graph (3) V = 600 mm/s**

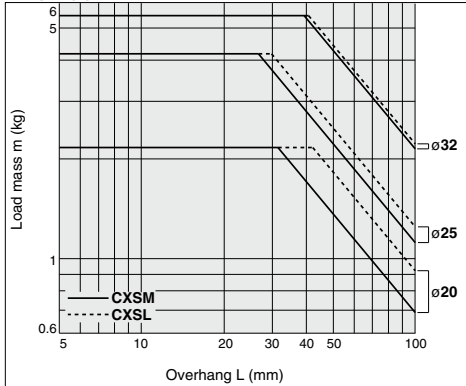

**Graph (4) V = 800 mm/s**

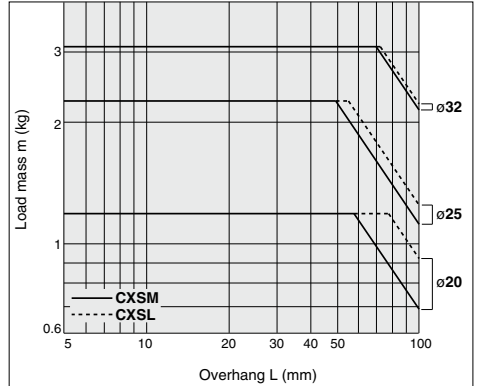

**Graph (5) V = 1000 mm/s**

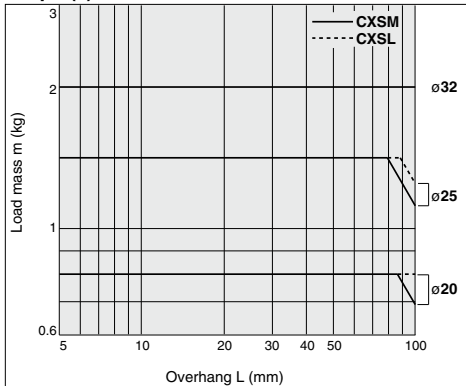

**CX2**

**CXW**

**CXT**

**CXSJ**

**CXS**

**D-□**

**-X□**

# CXS Series

## Horizontal Mounting

**Graph (6) V = Up to 800 mm/s; Up to 10 st**

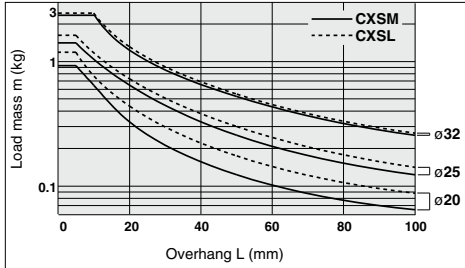

**Graph (7) V = Up to 1000 mm/s; Up to 10 st**

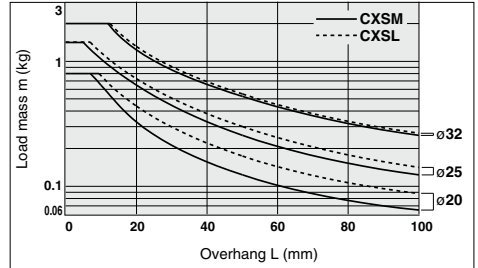

**Graph (8) V = Up to 800 mm/s; Up to 30 st**

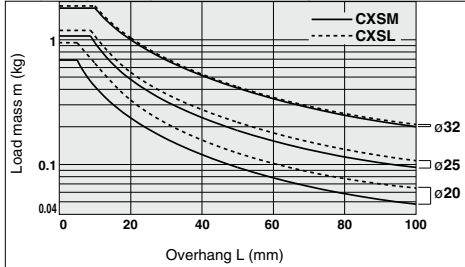

**Graph (9) V = Up to 1000 mm/s; Up to 30 st**

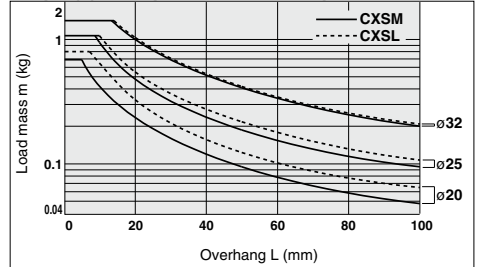

**Graph (10) V = Up to 1000 mm/s; Up to 50 st**

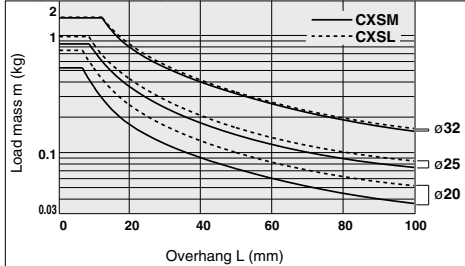

**Graph (11) V = Up to 1000 mm/s; Up to 75 st**

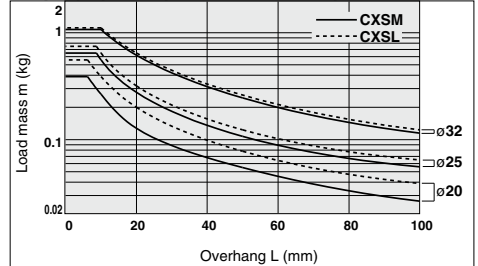

**Graph (12) V = Up to 1000 mm/s; Up to 100 st**

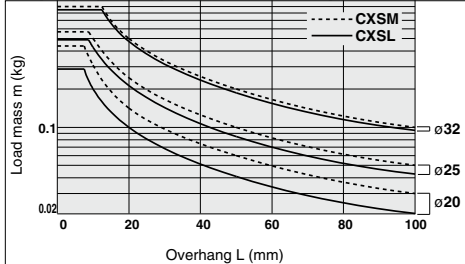

# Dual Rod Cylinder/Compact Type

# CXSJ Series

ø6, ø10, ø15, ø20, ø25, ø32

## How to Order

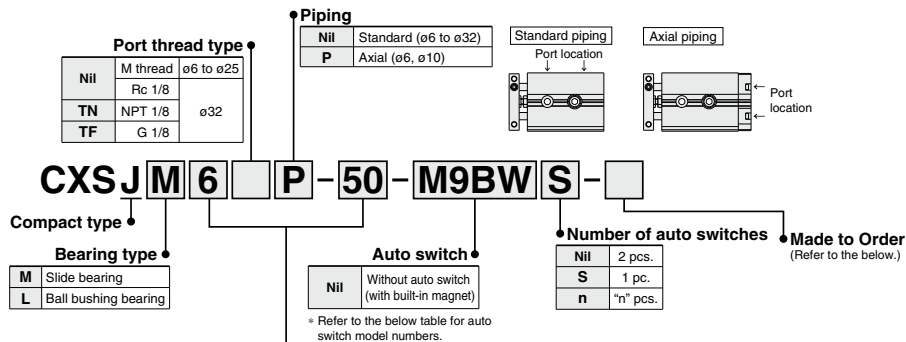

**CXSJ M 6 P - 50 - M9BW S -**

**Moisture Control Tube IDK Series**



When operating an actuator with a small diameter and a short stroke at a high frequency, the dew condensation (water droplet) may occur inside the piping depending on the conditions. Simply connecting the moisture control tube to the actuator will prevent dew condensation from occurring. For details, refer to [the IDK series in the Best Pneumatics No. 6](#).

**Made to Order** Click here for details

Symbol	Specifications
-XB6	Heat resistant cylinder (-10 to 150°C)
-XB11 (Nil <sup>1</sup> )	Long stroke type
-XB13	Low speed cylinder (5 to 50 mm/s)
-XC6 (Note 2)	Made of stainless steel
-XC19	Intermediate stroke (spacer)
-XC22	Fluoro rubber seals
-XC85	Grease for food processing equipment

**Bore size/Stroke** (mm)

Bore size	Standard stroke
6	10, 20, 30, 40, 50
10	10, 20, 30, 40, 50, 75
15	
20	10, 20, 30, 40, 50, 75, 100
25	
32	

Note 1) Except ø6, Axial type  
 Note 2) Slide bearing type (M) only

### Applicable Auto Switches/Refer to pages 1119 to 1245 for detailed auto switch specifications.

Type	Special function	Electrical entry	Indicator light	Wiring (output)	Load voltage		Auto switch model		Lead wire length (m) <sup>*1</sup>					Pre-wired connector	Applicable load	
					DC	AC	Perpendicular	In-line	0.5 (Nil)	1 (M)	3 (L)	5 (Z)				
Solid state auto switch	—	Grommet	Yes	3-wire (NPN)	5 V, 12 V	—	M9NV	M9N	●	●	●	○	○	IC circuit	Relay, PLC	
				3-wire (PNP)			M9PV	M9P	●	●	●	○				
				2-wire	M9BV	M9B	●	●	●	○	○					
				3-wire (NPN)	M9NVV	M9NW	●	●	●	○	○					
	Diagnostic indication (2-color indicator)			Water resistant (2-color indicator)	3-wire (PNP)	24 V	—	M9PWV	M9PW	●	●	●	○	○		IC circuit
					2-wire			M9BWW	M9BW	●	●	●	○	○		
					3-wire (NPN)	5 V, 12 V	M9NAV <sup>*1</sup>	M9NA <sup>*1</sup>	○	○	●	○	○	IC circuit		
					3-wire (PNP)		M9PAV <sup>*1</sup>	M9PA <sup>*1</sup>	○	○	●	○	○			
Read auto switch	—	Grommet	Yes	3-wire (NPN equiv.)	24 V	—	A96V	A96	●	—	●	—	—	IC circuit	—	
				2-wire			A93V <sup>*2</sup>	A93	●	●	●	—	—	Relay, PLC		
			None	—	5 V, 12 V	100 V or less	A90V	A90	●	—	●	—	—	IC circuit	—	

\*1 Water resistant type auto switches can be mounted on the above models, but in such case SMC cannot guarantee water resistance. Consult with SMC regarding water resistant types with the above model numbers.  
 \*2 1 m type lead wire is only applicable to D-A93.  
 \* Lead wire length symbols: 0.5 m ..... Nil (Example) M9NV M9NWM  
 1 m ..... M M9NVV M9NWL  
 3 m ..... L M9NAV<sup>\*1</sup> M9NA<sup>\*1</sup>  
 5 m ..... Z M9PAV<sup>\*1</sup> M9PA<sup>\*1</sup>

\* Solid state auto switches marked with "○" are produced upon receipt of order.

• Since there are applicable auto switches other than listed, refer to page 747 for details.  
 • For details about switch with pre-wired connector, refer to pages 1192 and 1193.  
 \* Auto switches are shipped together (not assembled).

- CX2**
- CXW**
- CXT**
- CXSJ**
- CXS**

- D-□**
- X□**

# CXSJ Series



## Operating Conditions

### Non-rotating Accuracy

Non-rotating accuracy  $\theta^\circ$  without a load should be less than or equal to the value provided in the table below as a guide.

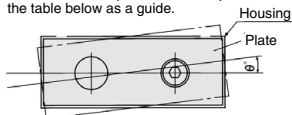

Bore size (mm)	$\theta$
CXSJM (Slide bearing)	$\pm 0.1^\circ$
CXSJL (Ball bushing bearing)	

### CXSJ $\square$ 6 to 32

#### Deflection at the Plate End

An approximate plate-end deflection X without a load is shown in the graph below.

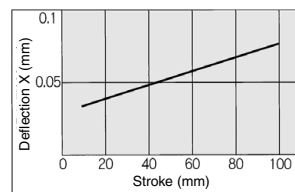
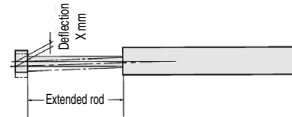

### Maximum Load Mass

When the cylinder is mounted as shown in the diagrams below, the maximum load mass W should not exceed the values illustrated in the graph.

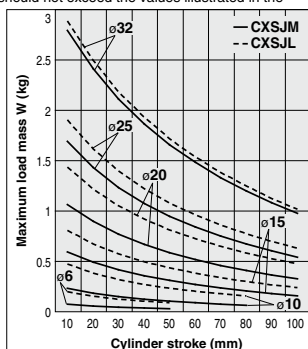
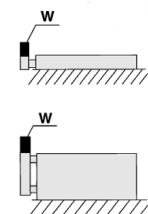

## Specifications

Bore size (mm)	6	10	15	20	25	32
Fluid	Air (Non-lube)					
Proof pressure	1.05 MPa					
Maximum operating pressure	0.7 MPa					
Minimum operating pressure	0.15 MPa	0.1 MPa	0.05 MPa			
Ambient and fluid temperature	-10 to 60°C (No freezing)					
Piston speed	30 to 800 mm/s		30 to 700 mm/s		30 to 600 mm/s	
Cushion	Rubber bumper on both ends					
Stroke adjustable range	0 to -5 mm compared to the standard stroke					
Port size	M3 x 0.5	M5 x 0.8				Pc (NPT, PF) 1/8
Allowable kinetic energy	0.016 J	0.064 J	0.095 J	0.17 J	0.27 J	0.32 J

## Standard Stroke

Model	Standard stroke	Long stroke (-XB11)
CXSJ $\square$ 6	10, 20, 30, 40, 50	—
CXSJ $\square$ 10	10, 20, 30, 40, 50, 75	80 to 150
CXSJ $\square$ 15	10, 20, 30, 40, 50, 75, 100	110 to 150
CXSJ $\square$ 20, 25, 32		110 to 200

## Theoretical Output

Bore size (mm)	Rod size (mm)	Operating direction	Piston area (mm <sup>2</sup> )	Operating pressure (MPa)							
				0.1	0.15	0.2	0.3	0.4	0.5	0.6	0.7
CXSJ $\square$ 6	4	OUT	56	—	8.4	11.2	16.8	22.4	28.0	33.6	39.2
		IN	31	—	4.6	6.2	9.3	12.4	15.5	18.6	21.7
CXSJ $\square$ 10	6	OUT	157	15.7	—	31.4	47.1	62.8	78.5	94.2	110
		IN	100	10.0	—	20.0	30.0	40.0	50.0	60.0	70.0
CXSJ $\square$ 15	8	OUT	353	35.3	—	70.6	106	141	177	212	247
		IN	252	25.2	—	50.4	75.6	101	126	151	176
CXSJ $\square$ 20	10	OUT	628	62.8	—	126	188	251	314	377	440
		IN	471	47.1	—	94.2	141	188	236	283	330
CXSJ $\square$ 25	12	OUT	982	98.2	—	196	295	393	491	589	687
		IN	756	75.6	—	151	227	302	378	454	529
CXSJ $\square$ 32	16	OUT	1608	161	—	322	482	643	804	965	1126
		IN	1206	121	—	241	362	482	603	724	844

Note) Theoretical output (N) = Pressure (MPa) x Piston area (mm<sup>2</sup>)

## Weight

Model	Standard stroke (mm)						
	10	20	30	40	50	75	100
CXSJM6	0.047	0.057	0.067	0.077	0.087	—	—
CXSJL6	0.048	0.058	0.068	0.078	0.088	—	—
CXSJM10	0.099	0.114	0.129	0.144	0.159	0.198	—
CXSJL10	0.106	0.121	0.136	0.151	0.166	0.205	—
CXSJM15	0.198	0.219	0.240	0.261	0.282	0.335	0.387
CXSJL15	0.218	0.239	0.260	0.281	0.302	0.355	0.407
CXSJM20	0.345	0.371	0.397	0.423	0.449	0.514	0.579
CXSJL20	0.375	0.401	0.427	0.453	0.479	0.544	0.609
CXSJM25	0.506	0.544	0.582	0.620	0.658	0.753	0.848
CXSJL25	0.516	0.554	0.592	0.630	0.668	0.763	0.858
CXSJM32	1.022	1.078	1.134	1.190	1.246	1.386	1.526
CXSJL32	1.032	1.088	1.144	1.200	1.256	1.396	1.536

Note) For axial piping of CXSJ  $\square$  6P- $\square$  and CXSJ  $\square$  10P- $\square$ , please add the following weight. CXSJ  $\square$  6P- $\square$ : 0.009 kg, CXSJ  $\square$  10P- $\square$ : 0.014 kg



## Construction: Standard Piping

### CXSJM (Slide bearing)

#### CXSJM6

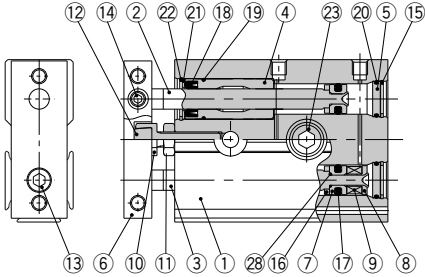

#### CXSJM10

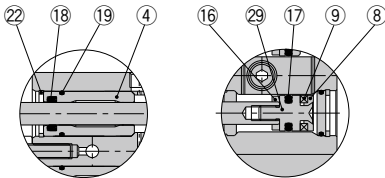

Rod cover

Piston rod B-side piston

### CXSJL (Ball bushing bearing)

#### CXSJL6

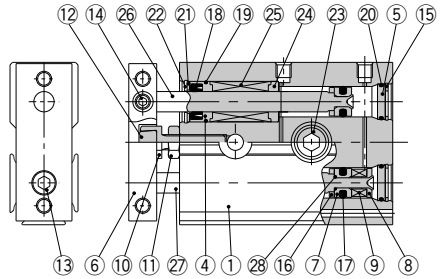

#### CXSJL10

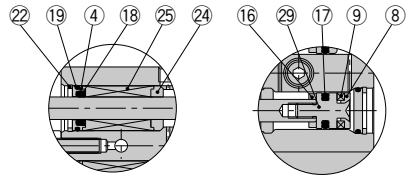

Rod cover

Piston rod B-side piston

### Component Parts: Standard Piping

No.	Description	Material	Note
1	Housing	Aluminum alloy	Hard anodized
2	Piston rod A	Carbon steel <small>Note)</small>	Hard chromium electroplated
3	Piston rod B	Carbon steel <small>Note)</small>	Hard chromium electroplated
4	Rod cover	Aluminum bearing alloy	
5	Head cover	Aluminum alloy	Anodized
6	Plate	Aluminum alloy	Glossy, self-coloring hard anodized
7	Piston A	Aluminum alloy	Chromated
8	Piston B	Aluminum alloy	Chromated
9	Magnet	—	
10	Bumper bolt	Carbon steel	Nickel plated
11	Hexagon nut	Carbon steel	Zinc chromated
12	Bumper	Urethane	
13	Hexagon socket head cap screw	Chromium steel	Zinc chromated
14	Hexagon socket head set screw	Chromium steel	Zinc chromated
15	Retaining ring	Special steel	Phosphate coated

Note) Stainless steel for CXSJM6.

No.	Description	Material	Note
16	Bumper B	Urethane	
17	Piston seal	NBR	
18	Rod seal	NBR	
19	O-ring	NBR	
20	O-ring	NBR	
21	Seal retainer	Stainless steel	
22	Retaining ring B	Special steel	Phosphate coated
23	Bolt holder	Stainless steel	
24	Bearing spacer	Aluminum bearing alloy	
25	Ball bushing	—	
26	Piston rod A	Special steel	Hard chromium electroplated
27	Piston rod B	Special steel	Hard chromium electroplated
28	O-ring	NBR	
29	Piston C	Stainless steel	
30	Bumper holder	Resin	

### Replacement Parts/Seal Kit

Model	Seal kit no.	Contents
CXSJM6	CXSJM6-PS	Set of nos. above 17, 18, and 20
CXSJL6	CXSJL6-PS	
CXSJM10	CXSJM10-PS	
CXSJL10	CXSJL10-PS	

\* Seal kit includes 17, 18, and 20. Order the seal kit, based on each bore size.

\* Since the seal kit does not include a grease pack, order it separately.

Grease pack part no.: GR-S-010 (10 g)

CX2

CXW

CXT

CXSJ

CXS

D-□

-X□

## Construction: Standard Piping

### CXSJM (Slide bearing)

#### CXSJM15

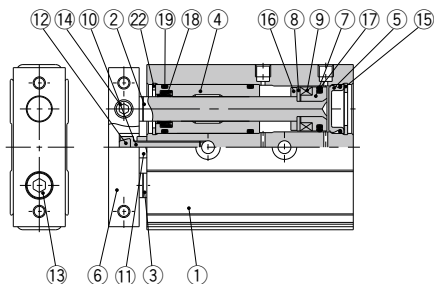

#### CXSJM20 to 32

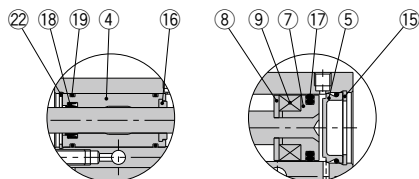

Rod cover

Head cover

### CXSJL (Ball bushing bearing)

#### CXSJL15

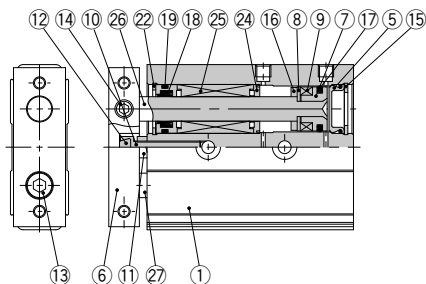

#### CXSJL20 to 32

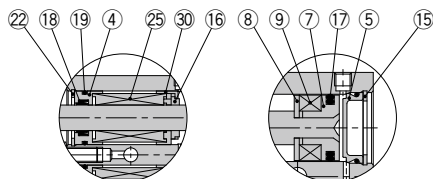

Rod cover

Head cover

### Component Parts: Standard Piping

No.	Description	Material	Note
1	Housing	Aluminum alloy	Hard anodized
2	Piston rod A	Carbon steel	Hard chromium electroplated
3	Piston rod B	Carbon steel	Hard chromium electroplated
4	Rod cover	Aluminum bearing alloy	
5	Head cover	Special steel	
6	Plate	Aluminum alloy	Glossy, self-coloring hard anodized
7	Piston A	Aluminum alloy	Chromated
8	Piston B	Stainless steel	
9	Magnet	—	
10	Bumper bolt	Carbon steel	Nickel plated
11	Hexagon nut	Carbon steel	Zinc chromated
12	Bumper	Urethane	
13	Hexagon socket head cap screw	Chromium steel	Zinc chromated
14	Hexagon socket head set screw	Chromium steel	Zinc chromated
15	Retaining ring	Special steel	Phosphate coated

No.	Description	Material	Note
16	Bumper B	Urethane	
17	Piston seal	NBR	
18	Rod seal	NBR	
19	O-ring	NBR	
20	O-ring	NBR	
21	Seal retainer	Stainless steel	
22	Retaining ring B	Special steel	Phosphate coated
23	Bolt holder	Stainless steel	
24	Bearing spacer	Resin	
25	Ball bushing	—	
26	Piston rod A	Special steel	Hard chromium electroplated
27	Piston rod B	Special steel	Hard chromium electroplated
28	O-ring	NBR	
29	Piston C	Stainless steel	
30	Bumper holder	Resin	

### Replacement Parts/Seal Kit

Model	Seal kit no.	Contents
CXSJM15	CXSM15-PS	Set of nos. above 17, 18, and 19
CXSJM20	CXSM20-PS	
CXSJM25	CXSM25-PS	
CXSJM32	CXSM32-PS	
CXSJL15	CXSL15APS	
CXSJL20	CXSL20APS	
CXSJL25	CXSL25APS	
CXSJL32	CXSL32APS	

\* Seal kit includes 17, 18, and 19. Order the seal kit, based on each bore size.

\* Since the seal kit does not include a grease pack, order it separately.

Grease pack part no.: GR-S-010 (10 g)

## Construction: Axial Piping

CXSJ□6P, CXSJ□10P

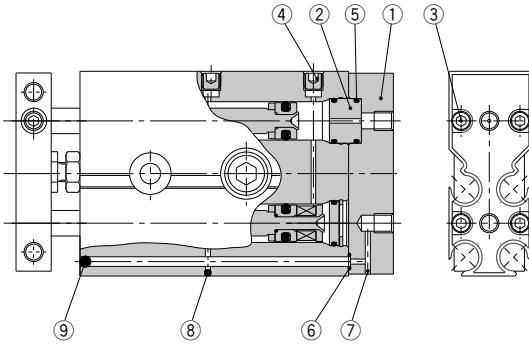

### Component Parts: Axial Piping

No.	Description	Material	Note
1	Cover	Aluminum alloy	Hard anodized
2	Adapter	Aluminum alloy	Anodized
3	Hexagon socket head cap screw	Chromium steel	Zinc chromated
4	Hexagon socket head plug	Chromium steel	Nickel plated
5	O-ring	NBR	
6	O-ring	NBR	
7	Steel ball	Special steel	Hard chromium electroplated
8	Steel ball	Special steel	Hard chromium electroplated
9	Steel ball	Special steel	Hard chromium electroplated

\* Parts other than those listed above are the same as those of CXSJ basic type.

## Clean Series

There are two types of cylinders, relieving type and vacuum type, available for a clean room environment. The relieving type specification with the double-seal construction of the rod section allows the cylinder to channel exhaust through the relief port directly to the outside of a clean room environment. The vacuum type specification allows for the application of a vacuum on the rod section while forced exhaust of air takes place through the vacuum port to the outside of a clean room environment.

### How to Order

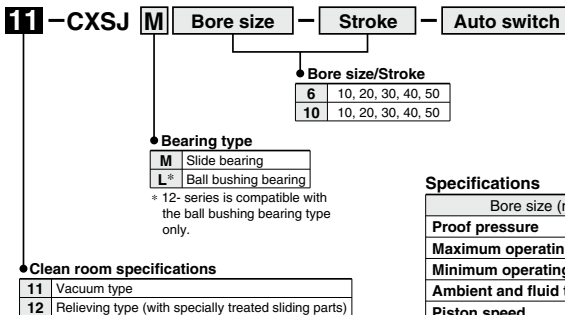

### Specifications

	Bore size (mm)	
	6	10
Proof pressure	1.05 MPa	
Maximum operating pressure	0.7 MPa	
Minimum operating pressure	0.15 MPa	0.1 MPa
Ambient and fluid temperature	-10 to 60°C (No freezing)	
Piston speed	30 to 400 mm/s	
Stroke adjustable range	0 to -5 mm compared to the standard stroke	
Bearing type	Slide bearing, Ball bushing bearing	

\* Refer to "Pneumatic Clean Series" catalog (CAT.E02-23) for dimensions.

CX2

CXW

CXT

CXSJ

CXS

D-□

-X□

# CXSJ Series

## Cylinder with Stable Lubrication Function (Lube-retainer)

### How to Order

CXSJ Bearing type Bore size **M** — Stroke — Auto switch Number of auto switches

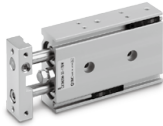

• Cylinder with Stable Lubrication Function (Lube-retainer)

### Specifications

Bore size [mm]	6	10	15	20	25	32
Min. operating pressure	0.2 MPa	0.15 MPa		0.1 MPa		
Piston speed	50 to 800 mm/s		50 to 700 mm/s		50 to 600 mm/s	

\* Specifications other than the above are the same as the standard type.

### Dimensions (Dimensions other than those shown below are the same as those of the standard model.)

#### CXSJ□6, 10M

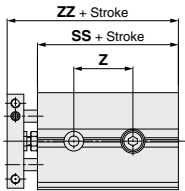
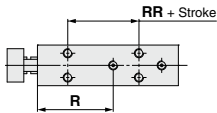

#### CXSJ□15 to 32M

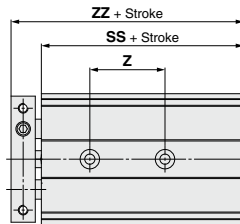
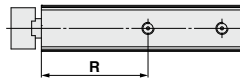

Model	[mm]			
	R	RR	SS	ZZ
CXSJ□6M	25	13.5	36.5	46.5
CXSJ□10M	33.5	17	49.5	61
CXSJ□15M	44	—	63.5	76
CXSJ□20M	51	—	73.5	90
CXSJ□25M	52	—	76.5	93
CXSJ□32M	66	—	90.5	110.5

Model	Stroke	Z [mm]						
		10	20	30	40	50	75	100
CXSJ□6M	19.5	29.5	39.5	49.5	59.5	—	—	
CXSJ□10M	23	33	43	53	63	88	—	
CXSJ□15M	31	—	41	—	51	61	—	
CXSJ□20M	36	—	46	—	—	66	—	
CXSJ□25M	37	—	47	—	—	67	—	
CXSJ□32M	50	—	60	—	—	80	—	

For details, refer to the [Web Catalog](#).

CX2

CXW

CXT

CXSJ

CXS

D-□

-X□





**Dimensions:  $\phi 10$  Standard Piping**

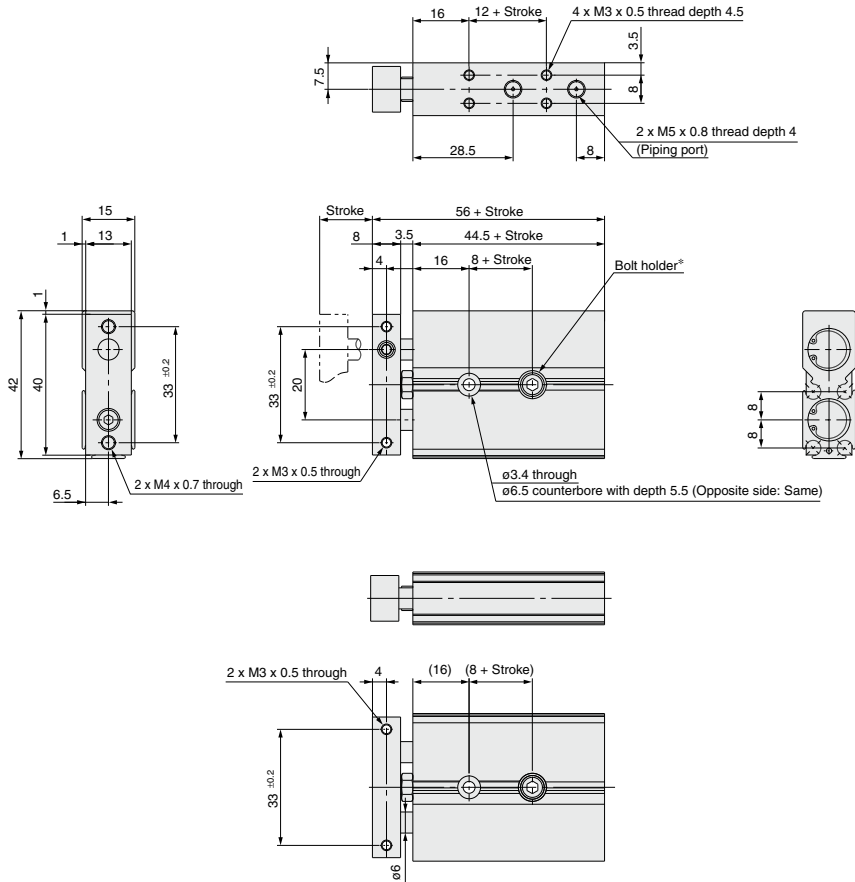

\* For bolt holder, refer to page 748, "Mounting".

**CX2**

**CXW**

**CXT**

**CXSJ**

**CXS**

**D-□**

**-X□**

# CXSJ Series

## Dimensions: $\phi 6$ , $\phi 10$ Axial Piping

### CXSJ□6P

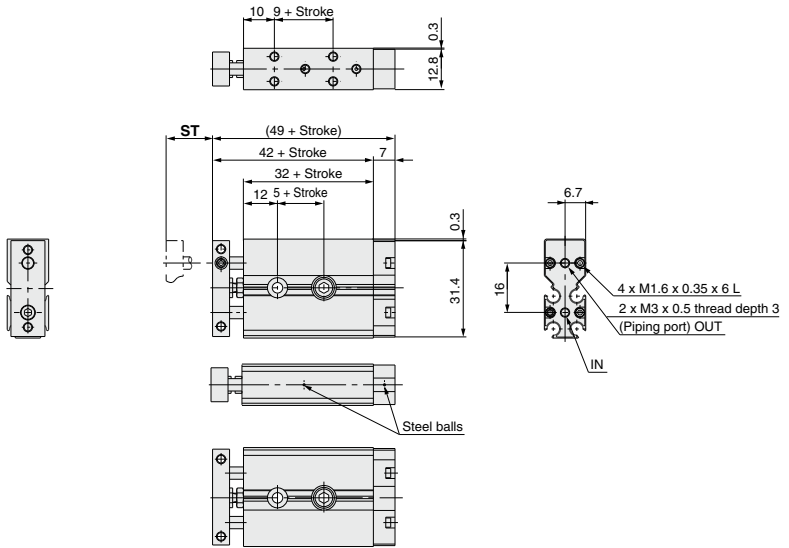

### CXSJ□10P

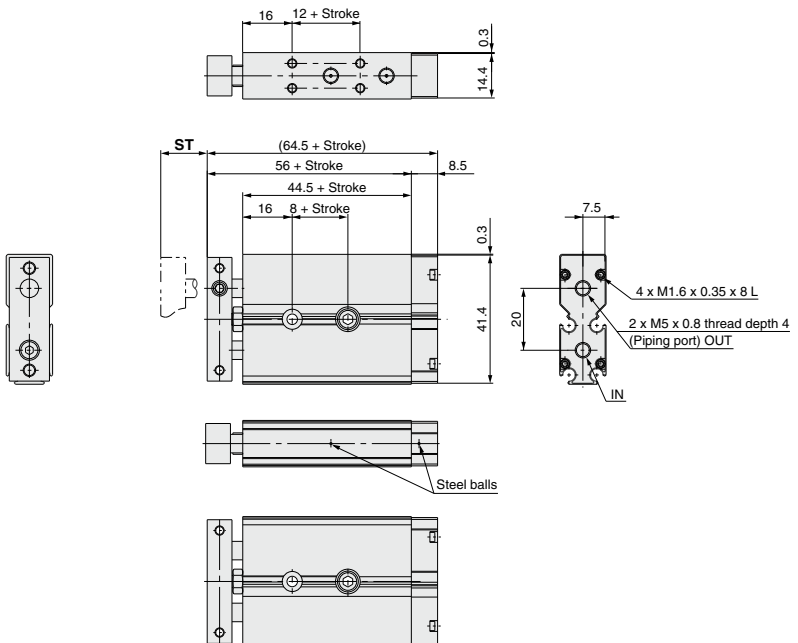



**Dimensions: ø15 to 32 Standard Piping**

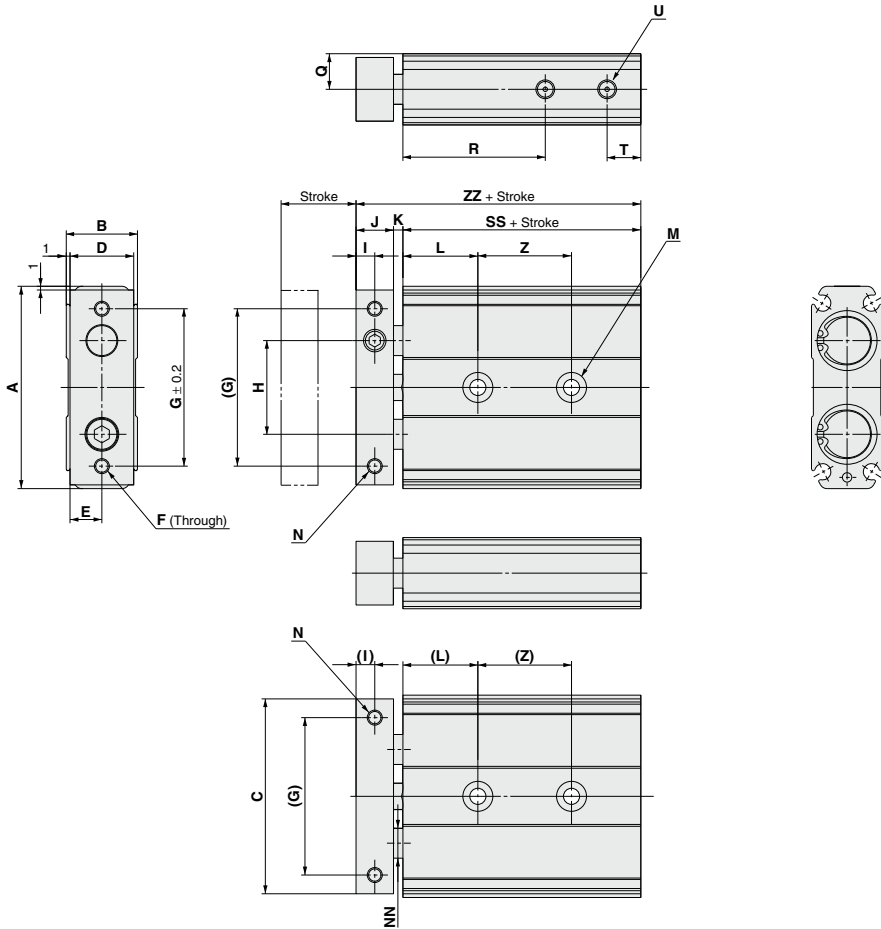

Bore size (mm)	A	B	ZZ	C	D	E	F	G	H	I	J	K	L	M	N	NN	Q	R	T	U	SS
15	54	19	70	52	17	8.5	2 x M5 x 0.8	42	25	5	10	2.5	20	2 x 2 x ø4.3 through 2 x 2 x ø6 counterbore with depth 4.2	2 x M4 x 0.7 with thread depth 6	ø8	9.5	38	9	2 x M5 x 0.8 with thread depth 4	57.5
20	62	24	84	60	22	11	2 x M5 x 0.8	50	29	6	12	4.5	25	2 x 2 x ø5.3 through 2 x 2 x ø8.5 counterbore with depth 5.3	2 x M4 x 0.7 with thread depth 6	ø10	12	45	9	2 x M5 x 0.8 with thread depth 4	67.5
25	73	29	87	71	27	13.5	2 x M6 x 1.0	60	35	6	12	4.5	30	2 x 2 x ø6.5 through 2 x 2 x ø11 counterbore with depth 6.3	2 x M5 x 0.8 with thread depth 7.5	ø12	14.5	46	9	2 x M5 x 0.8 with thread depth 4	70.5
32	94	37	100.5	92	35	17.5	2 x M6 x 1.0	75	45	8	16	4	30	2 x 2 x ø6.5 through 2 x 2 x ø11 counterbore with depth 6.3	2 x M5 x 0.8 with thread depth 7.5	ø16	18.5	56	10	2 x Rc1/8 with thread depth 5	80.5

Bore size (mm)	Symbol		Z				
	Stroke		10, 20	30, 40, 50	75	100	
15	25		35	45	55		
20	30		40	60	60		
25	30		40	60	60		
32	40		50	70	70		

**CX2**

**CXW**

**CXT**

**CXSJ**

**CXS**

**D-□**

**-X□**

# CXSJ Series Auto Switch Mounting

## Auto Switch Proper Mounting Position for Stroke End Detection

### CXSJ□6, 10

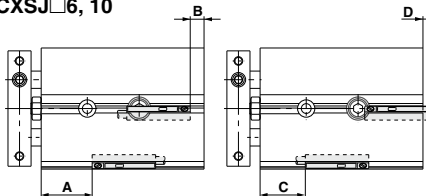

### Operating Range

Auto switch model	Bore size (mm)					
	6	10	15	20	25	32
D-A9□, D-A9□V	5	6	6	7.5	8	9
D-M9□, D-M9□V						
D-M9□A, D-M9□AV	2.5	3	3.5	4.5	4.5	5
D-M9□W, D-M9□WV						

\* The operating ranges are provided as guidelines including hystereses and are not guaranteed values (assuming approximately ±30% variations). They may vary significantly with ambient environments.

### CXSJ□15 to 32

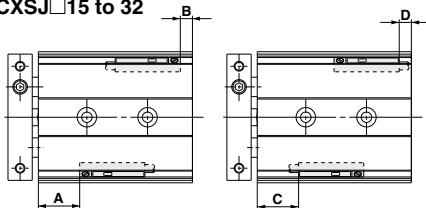

Electrical entry direction:  
Inward

Electrical entry direction:  
Outward

### Auto Switch Proper Mounting Position

Bore size (mm)	D-A90, D-A96				D-A93				D-M9□, D-M9□W D-M9□AV				D-M9□V, D-M9□WV			
	A	B	C	D	A	B	C	D	A	B	C	D	A	B	C	D
6	15.5	—	13.5	5.5	15.5	—	11	8	19.5	0.5	9.5	9.5	19.5	0.5	11.5	7.5
10	25.5	—	23.5	3	25.5	—	21	5.5	29.5	3	19.5	7	29.5	3	21.5	5
15	31.5	6	29.5	4	31.5	6	27	1.5	35.5	10	25.5	0	35.5	10	27.5	2
20	39	9	37	7	39	9	34.5	4.5	43	13	33	3	43	13	35	5
25	40	11	38	9	40	11	35.5	6.5	44	15	34	5	44	15	36	7
32	49	11.5	47	9.5	49	11.5	44.5	7	53	15.5	43	5.5	53	15.5	45	7.5

Bore size (mm)	D-M9□A			
	A	B	C	D
6	19.5	0.5	7.5	11.5
10	29.5	3	17.5	9
15	35.5	10	23.5	2
20	43	13	31	5
25	44	15	32	7
32	53	15.5	41	7.5

Note 1) ø6: D-A90, A96, A93, F9BA

ø10: D-A90, A96, A93  
Only outward electrical entry (D dimension) is available.

Note 2) Minus value in D column (ø15, ø20, ø25, ø32) means that the auto switches are to be mounted beyond the cylinder body edges.

Note 3) When setting an auto switch, confirm the operation and adjust its mounting position.

## Auto switch mounting dimensions

### CXSJ□6,10

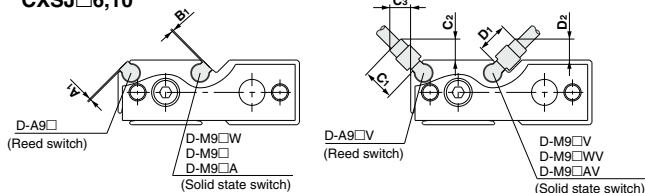

Auto switch model	Symbol	Bore size (mm)	
		6	10
D-A9□	A <sub>1</sub>	1	1
D-M9□, D-M9□W	B <sub>1</sub>	1	1
D-M9□A	B <sub>1</sub>	2	2
D-A9□V	C <sub>1</sub> , D <sub>1</sub>	5.5	5.5
D-M9□V, D-M9□WV	C <sub>2</sub> , C <sub>3</sub> , D <sub>2</sub>	4	4
D-M9□AV	C <sub>1</sub> , D <sub>1</sub>	8	8
D-M9□WV	C <sub>2</sub> , C <sub>3</sub> , D <sub>2</sub>	6	6

### CXSJ□15 to 32

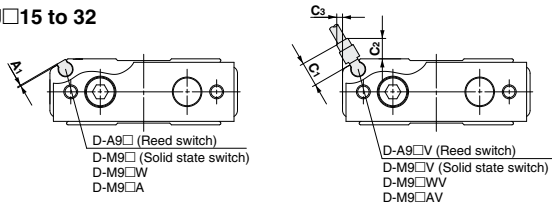

Auto switch model	Symbol	Bore size (mm)			
		15	20	25	32
D-M9□, D-M9□W	A <sub>1</sub>	1	1	1	1
D-M9□A	A <sub>1</sub>	2	2	2	2
D-A9□V	C <sub>1</sub>	5.5	5.5	5.5	5.5
D-M9□WV	C <sub>2</sub>	4.5	4.5	4.5	4.5
D-M9□AV	C <sub>3</sub>	1	—	—	—

## Auto Switch Mounting

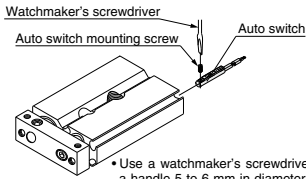

- Use a watchmaker's screwdriver with a handle 5 to 6 mm in diameter when tightening the auto switch mounting screw.

**Tightening Torque of Auto Switch Mounting Screw (N·m)**

Auto switch model	Tightening torque
D-M9□(V)	0.05 to 0.15
D-M9□W(V)	
D-A93	
D-M9□A(V)	0.05 to 0.10
D-A9□(V) (Excludes the D-A93)	0.10 to 0.20

### ⚠ Caution

① **Avoid proximity to magnetic objects.**

When magnetic substances such as iron (including flange brackets) are in close proximity to an auto switch cylinder (auto switch mounting side), be sure to provide a clearance between the magnetic substance and the cylinder body as shown in the drawing below. If the clearance is less than 10 mm, the auto switch may not function properly.

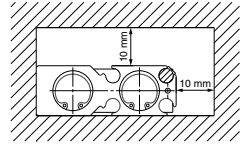

② **For CXSJ□6/10, the switch cannot be attached or detached from the plate side if the middle groove (indicated by arrows in the figure on the right) is used. (It will interfere with the bumper bolt at the end of the groove.)**

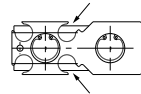

Other than the applicable auto switches listed in "How to Order," the following auto switches can be mounted.

\* Normally closed (NC = b contact) solid state auto switches (D-M9□E(V)) are also available. For details, refer to page 1592-1.

CX2

CXW

CXT

CXSJ

CXS

D-□

-X□



# CXSJ Series

## Specific Product Precautions

Be sure to read this before handling the products.

Refer to back page 50 for Safety Instructions and pages 3 to 12 for Actuator and Auto Switch Precautions.

### Mounting

#### ⚠ Caution

1. Make sure that the surface on which the cylinder is to be mounted is flat (reference value for flatness: 0.05 or less).

Dual-rod cylinders can be mounted from 3 directions, however, make sure that the surface on which the cylinder is to be mounted is flat (reference value for flatness: 0.05 or less). Otherwise, the accuracy of the piston rod operation is not achieved, and malfunctioning can occur.

2. The piston rod must be retracted when mounting the cylinder.

Scratches or gouges in the piston rod may lead to damaged bearings and seals and cause malfunctions or air leakage.

3. CXSJ (ø6, ø10)

Adjust the bolt holder using a hexagon wrench 3 mm in width across flats so that it does not protrude from the cylinder surface (approx. 0.5 mm depth from the cylinder surface to the top of the holder). If the bolt holder is not properly adjusted, it can interfere with the switch rail, hindering the auto switch mounting. The required length of the mounting bolt for a bolt holder and mounting hole in the rod cover side varies depending on the bearing surface position for the mounting bolt. Refer to dimensions L<sub>1</sub> and L<sub>2</sub> provided below to select the appropriate mounting bolt length.

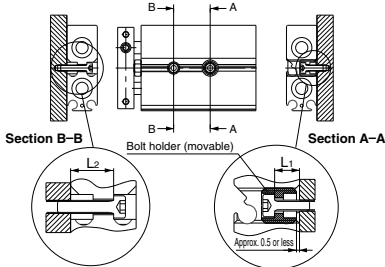

	L <sub>1</sub> (mm)	L <sub>2</sub> (mm)	Applicable mounting bolt size
CXSJ□6	5	8.4	M3
CXSJ□10	5	9.5	M3

Be sure to mount the cylinder to the bolt holder. If it is operated without using the bolt holder, the bolt holder may drop.

### Piping

#### ⚠ Caution

1. For axial piping, the side port of the standard cylinder is plugged. However, a plugged port can be switched according to the operating conditions. When changing the port position, use the removed plug or a new plug. If reusing the removed plug, apply sealant, etc., before reassembly. If using a new M5 plug, apply a thin layer of grease all the way around the male thread before use. In addition, clear any foreign matter adhered to the port the plug was removed from before piping. After reassembly, be sure to check for air leakage before operating the product.

Plug part no.: (ø6) MTS08-08-P6830  
(ø10) CXS10-08-R8601

### Stroke Adjustment

#### ⚠ Caution

1. After adjusting the stroke, make sure to tighten the hexagon nut to prevent it from loosening.

Dual-rod cylinders have a bolt to adjust 0 to -5 mm strokes on the retracted end (IN).

Loosen the hexagon nut to adjust the stroke; however, make sure to tighten the hexagon nut after making an adjustment.

2. Never operate a cylinder with its bumper bolt removed. Also, do not attempt to tighten the bumper bolt without using a nut.

If the bumper bolt is removed, the piston hits the head cover causing damage to the cylinder. Therefore, do not use a cylinder without a bumper bolt.

Furthermore, if the bumper bolt is tightened without a nut, the piston seal is caught in the leveled part, damaging the seal.

3. A bumper at the end of the bumper bolt is replaceable.

In case of a missing bumper, or a bumper has a permanent setting, use the

right part numbers for ordering.

Bore size (mm)	6, 10, 15	20, 25	32
Part no.	CXS10-34A 28747	CXS20-34A 28749	CXS32-34A 28751
Qty.	1		

### Disassembly and Maintenance

#### ⚠ Caution

1. Never use a cylinder with its plate removed.

When removing the hexagon socket head cap screw on the end plate, the piston rod must be secured to prevent from rotating. However, if the sliding parts of the piston rod are scratched and gouged, a malfunction may occur.

2. When disassembling and reassembling the cylinder, contact SMC or refer to the separate operation manual.

#### ⚠ Warning

1. Take precautions when your hands are near the plate and housing.

When the cylinder is operated, take extra precautions to avoid getting your hands and fingers caught between the plate and housing, that can cause a bodily injury.

### Operating Environment

#### ⚠ Caution

1. Do not operate the cylinder in a pressurized environment.  
The pressurized air may flow inside the cylinder due to its construction.
2. Do not use as a stopper. This may cause malfunction.  
When using as a stopper, select a stopper cylinder (RS series) or a compact guide cylinder (MGP series).

### Speed Adjustment

#### ⚠ Caution

1. A sudden extension may occur with CXSJ□6.

CXSJ□6 has a low internal volume and sudden extension/erratic movement may occur particularly when it is used at low speed. This sudden extension can be mitigated by combining the use of meter-in and meter-out speed controllers.

# Dual Rod Cylinder Basic Type

# CXS Series

ø6, ø10, ø15, ø20, ø25, ø32

## How to Order

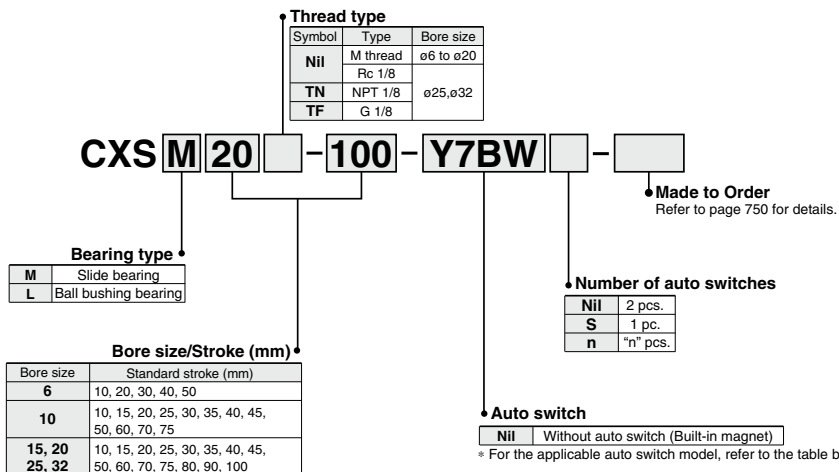

## Applicable Auto Switches

Refer to pages 1119 to 1245 for further information on auto switches.

Type	Special function	Electrical entry	Indicator light	Wiring (Output)	Load voltage		Auto switch model		Lead wire length (m)*			Pre-wired connector	Applicable load		
					DC	AC	Perpendicular	In-line	0.5 (Nil)	3 (L)	5 (Z)				
Solid state auto switch	—	Grommet	Yes	3-wire (NPN)	5 V, 12 V	—	<b>Y69A</b>	<b>Y59A</b>	●	●	○	○	IC circuit		
				3-wire (PNP)			<b>Y7PV</b>	<b>Y7P</b>	●	●	○	○			
				2-wire	12 V		<b>Y69B</b>	<b>Y59B</b>	●	●	○	○		—	
				3-wire (NPN)	5 V, 12 V		<b>Y7NWV</b>	<b>Y7NW</b>	●	●	○	○		IC circuit	
				3-wire (PNP)			<b>Y7PWV</b>	<b>Y7PW</b>	●	●	○	○		—	
Reed auto switch	—	Grommet	Yes	3-wire (NPN equivalent)	—	5 V	—	<b>Z76</b>	●	●	—	—	IC circuit	—	
				2-wire	24 V	12 V	100 V	—	<b>Z73</b>	●	●	●	—	—	Relay, PLC
					100 V or less	—	—	—	<b>Z80</b>	●	●	—	—	IC circuit	—

\*\* Water resistant type auto switches can be mounted on the above models, but in such case SMC cannot guarantee water resistance.

Consult with SMC regarding water resistant types with the above model numbers.

\* Lead wire length symbols: 0.5 m ..... Nil (Example) Y59A

3 m ..... L (Example) Y59AL

5 m ..... Z (Example) Y59AZ

\* Solid state auto switches marked with "○" are produced upon receipt of order.

• Since there are other applicable auto switches than listed, refer to page 758 for details.

• For details about auto switches with pre-wired connector, refer to pages 1192 and 1193.

• Auto switches are shipped together (not assembled).

CX2

CXW

CXT

CXSJ

CXS

D-□

-X□



**Made to Order** **Made to Order: Individual Specifications**  
(For details, refer to page 759.)

Symbol	Specifications
-X593	Without plate

**Made to Order Specifications**

[Click here for details](#)

Symbol	Specifications
-XB6	Heat resistant cylinder (-10 to 150°C)
-XB9	Low speed cylinder (10 to 50 mm/s)
-XB11	Long stroke type
-XB13	Low speed cylinder (5 to 50 mm/s)
-XB19	High speed specification
-XC22	Fluororubber seals
-XC85	Grease for food processing equipment

**Moisture Control Tube**  
**IDK Series**



When operating an actuator with a small diameter and a short stroke at a high frequency, the dew condensation (water droplet) may occur inside the piping depending on the conditions. Simply connecting the moisture control tube to the actuator will prevent dew condensation from occurring. For details, refer to [the IDK series in the Best Pneumatics No. 6](#).

## Specifications

Bore size (mm)	6	10	15	20	25	32
Fluid	Air (Non-lube)					
Proof pressure	1.05 MPa					
Maximum operating pressure	0.7 MPa					
Minimum operating pressure	0.15 MPa	0.1 MPa		0.05 MPa		
Ambient and fluid temperature	-10 to 60°C (No freezing)					
Piston speed	30 to 300 mm/s	30 to 800 mm/s	30 to 700 mm/s		30 to 600 mm/s	
Cushion	Rubber bumper					
Stroke adjustable range	0 to -5 mm compared to the standard stroke					
Port size	M5 x 0.8				Rc 1/8	
Bearing type	Slide bearing, Ball bushing bearing (Same dimensions for both)					
Allowable kinetic energy	0.0023 J	0.064 J	0.095 J	0.17 J	0.27 J	0.32 J

## Standard Stroke

Model	Standard stroke		Long stroke		
	(mm)				
CXS□6	10, 20, 30, 40, 50	60, 70, 75, 80, 90, 100			
CXS□10	10, 15, 20, 25, 30, 35, 40, 45, 50, 60, 70, 75	80, 90, 100, 110, 120, 125, 150			
CXS□15	110, 120, 125, 150				
CXS□20	10, 15, 20, 25, 30, 35, 40, 45, 50,	110, 120, 125, 150, 175, 200			
CXS□25	60, 70, 75, 80, 90, 100				
CXS□32					

\* Refer to "Made to Order Specifications" for stroke which exceeds the standard stroke length.  
Non-standard strokes for a size ø6 cylinder are available as a special order.

## Theoretical Output

Model	Rod size (mm)	Operating direction	Piston area (mm <sup>2</sup> )	Operating pressure (MPa)								
				0.1	0.15	0.2	0.3	0.4	0.5	0.6	0.7	
CXS□6	4	OUT	56	—	8.4	11.2	16.8	22.4	28.0	33.6	39.2	
		IN	31	—	4.6	6.2	9.3	12.4	15.5	18.6	21.7	
CXS□10	6	OUT	157	15.7	—	31.4	47.1	62.8	78.5	94.2	110	
		IN	100	10.0	—	20.0	30.0	40.0	50.0	60.0	70.0	
CXS□15	8	OUT	353	35.3	—	70.6	106	141	177	212	247	
		IN	252	25.2	—	50.4	75.6	101	126	151	176	
CXS□20	10	OUT	628	62.8	—	126	188	251	314	377	440	
		IN	471	47.1	—	94.2	141	188	236	283	330	
CXS□25	12	OUT	982	98.2	—	196	295	393	491	589	687	
		IN	756	75.6	—	151	227	302	378	454	529	
CXS□32	16	OUT	1608	161	—	322	482	643	804	965	1126	
		IN	1206	121	—	241	362	482	603	724	844	

(Note) Theoretical output (N) = Pressure (MPa) x Piston area (mm<sup>2</sup>)

## Weight

Model	Standard stroke (mm)														
	10	15	20	25	30	35	40	45	50	60	70	75	80	90	100
CXSM 6	0.081	—	0.095	—	0.108	—	0.122	—	0.135	—	—	—	—	—	—
CXSL 6	0.081	—	0.095	—	0.108	—	0.122	—	0.135	—	—	—	—	—	—
CXSM10	0.15	0.16	0.17	0.18	0.19	0.20	0.21	0.22	0.23	0.25	0.27	0.28	—	—	—
CXSL 10	0.15	0.16	0.17	0.18	0.19	0.20	0.21	0.22	0.23	0.25	0.27	0.28	—	—	—
CXSM15	0.25	0.265	0.28	0.29	0.30	0.315	0.33	0.345	0.36	0.39	0.42	0.435	0.45	0.48	0.51
CXSL 15	0.27	0.285	0.30	0.31	0.32	0.335	0.35	0.365	0.38	0.41	0.44	0.455	0.47	0.50	0.53
CXSM20	0.40	0.42	0.44	0.46	0.48	0.495	0.51	0.53	0.55	0.585	0.62	0.64	0.66	0.70	0.74
CXSL 20	0.43	0.445	0.46	0.48	0.50	0.515	0.53	0.55	0.57	0.605	0.64	0.66	0.68	0.715	0.75
CXSM25	0.61	0.635	0.66	0.69	0.72	0.745	0.77	0.80	0.83	0.89	0.95	0.97	0.995	1.06	1.10
CXSL 25	0.62	0.645	0.67	0.70	0.73	0.755	0.78	0.81	0.84	0.895	0.955	0.98	1.005	1.065	1.11
CXSM32	1.15	1.19	1.23	1.275	1.32	1.36	1.40	1.45	1.49	1.58	1.665	1.71	1.755	1.84	1.93
CXSL 32	1.16	1.205	1.25	1.295	1.34	1.38	1.42	1.465	1.51	1.595	1.68	1.72	1.765	1.855	1.94

## Operating Conditions

### Non-rotating Accuracy

Non-rotating accuracy  $\theta^\circ$  at the retracted end and without a load should be less than or equal to the value provided in the table below as a guide.

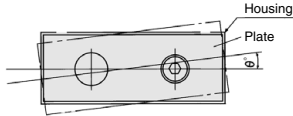

Bore size (mm)	$\phi 6$ to $\phi 32$
<b>CXSM</b> (Slide bearing)	$\pm 0.1^\circ$
<b>CXSL</b> (Ball bushing bearing)	

### CXS $\phi 6$ to 32

#### Deflection at the Plate End

An approximate plate-end deflection X without a load is shown in the graph below.

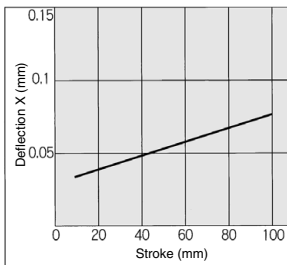
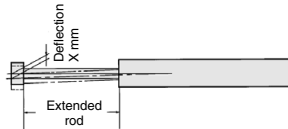

### Maximum Load Mass

When the cylinder is mounted as shown in the diagrams below, the maximum load mass W should not exceed the values illustrated in the graph.

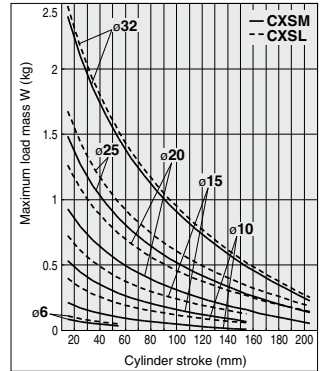
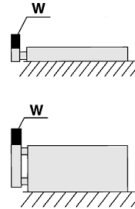

CX2

CXW

CXT

CXSJ

**CXS**

D-□

-X□

# CXS Series

## Clean Series

There are two types of cylinders, relieving type and vacuum type, available for a clean room environment. The relieving type specification with the double-seal construction of the rod section allows the cylinder to channel exhaust through the relief port directly to the outside of a clean room environment. The vacuum type specification allows for the application of a vacuum on the rod section while forced exhaust of air takes place through the vacuum port to the outside of a clean room environment.

### How to Order

**12** – CXS L Bore size – Stroke – Auto switch

#### Clean room specifications

10	Relieving type
11	Vacuum type
12	Relieving type (With specially treated sliding parts)

#### Ball bushing bearing

M	Slide bearing
L*	Ball bushing bearing

\* 12-series is compatible with the ball bushing bearing type only.

### Series Applicable to Operating Environments that Do Not Accept Copper

- Copper (Cu) and Zinc (Zn)-free.....25A-series
- Copper and Fluorine-free.....20-series

\* For details, refer to the [Web Catalog](#).

### Specifications

Bore size (mm)	6	10	15	20	25	32
<b>Proof pressure</b>	1.05 MPa					
<b>Maximum operating pressure</b>	0.7 MPa					
<b>Minimum operating pressure</b>	0.15 MPa	0.1 MPa	0.1 MPa	0.05 MPa		
<b>Ambient and fluid temperature</b>	-10 to 60°C (No freezing)					
<b>Piston speed</b>	30 to 400 mm/s					
<b>Stroke adjustable range</b>	0 to -5 mm compared to the standard stroke					
<b>Bearing type</b>	Ball bushing bearing					

Refer to "Pneumatic Clean Series" catalog (CAT.E02-23) for dimensions.

## Cylinder with Stable Lubrication Function (Lube-retainer)

### How to Order

CXS Bearing type Bore size M – Stroke – Auto switch

↓ Cylinder with Stable Lubrication Function (Lube-retainer)

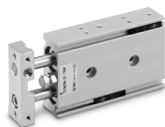

### Specifications

Bore size (mm)	6	10	20	25	32
<b>Action</b>	Double acting				
<b>Minimum operating pressure</b>	0.2 MPa	0.15 MPa	0.1 MPa		
<b>Piston speed</b>	50 to 300 mm/s	50 to 800 mm/s	50 to 700 mm/s	50 to 600 mm/s	
<b>Cushion</b>	Rubber bumper				

\* Specifications other than the above are the same as the standard model.

## Dimensions

(Dimensions other than those shown below are the same as the standard model.)

### CXS□6

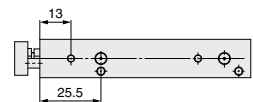
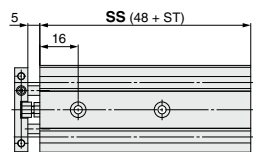

### CXS□10 to 32

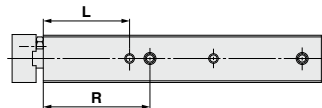
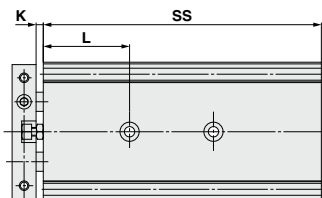

Model	K	L	R
CXS□10	4	25	35
CXS□15	3	36	44.5
CXS□20	6	36	50.5
CXS□25	6	36	52
CXS□32	4	40	66

Symbol	SS															
Model	Stroke	10	15	20	25	30	35	40	45	50	60	70	75	80	90	100
CXS□10	70	75	80	85	90	95	100	105	110	120	130	135	—	—	—	—
CXS□15	76	81	86	91	96	101	106	111	116	126	136	141	146	156	166	—
CXS□20	86	91	96	101	106	111	116	121	126	136	146	151	156	166	176	—
CXS□25	88	93	98	103	108	113	118	123	128	138	148	153	158	168	178	—
CXS□32	102	107	112	117	122	127	132	137	142	152	162	167	172	182	192	—

For details, refer to the [Web Catalog](#).



**Construction: Slide Bearing**

**CXSM6**

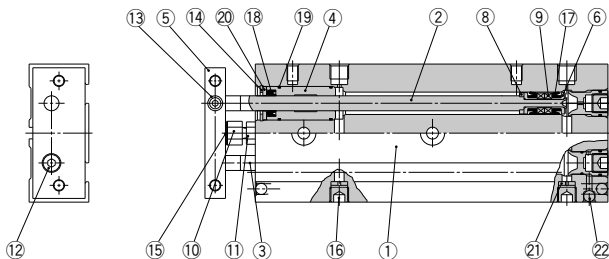

**CXSM10 to 32**

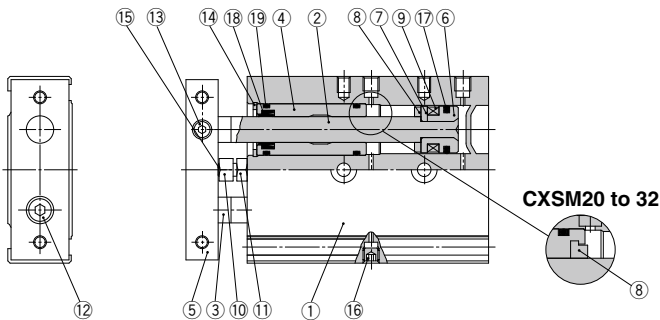

**Component Parts**

No.	Description	Material	Note
1	Housing	Aluminum alloy	Hard anodized
2	Piston rod A	Carbon steel <sup>(1)</sup>	Hard chrome plated
3	Piston rod B	Carbon steel <sup>(1)</sup>	Hard chrome plated
4	Rod cover	Aluminum bearing alloy	
5	Plate	Aluminum alloy	Anodized
6	Piston A	Aluminum alloy	Chromated
7	Piston B	Aluminum alloy	Chromated
8	Bumper	Urethane	
9	Magnet	—	
10	Bumper bolt	Carbon steel	Nickel plated
11	Hexagon nut	Carbon steel	Zinc chromated
12	Hexagon socket head cap screw	Chromium steel	Zinc chromated
13	Hexagon socket head set screw	Chromium steel	Zinc chromated
14	Retaining ring	Special steel	Phosphate coating

Note 1) Stainless steel for CXSM6.

**Component Parts**

No.	Description	Material	Note
15	Bumper	Urethane	
16	Plug	Chromium steel	Nickel plated
17	Piston seal	NBR	
18	Rod seal	NBR	
19	O-ring	NBR	
20	Seal retainer	Aluminum alloy	
21	Port spacer	Aluminum alloy	
22	Steel ball	Special steel	Hard chrome plated

**Replacement Parts/Seal Kit**

Bore size (mm)	Kit no.	Contents
6	CXSM6-PS	
10	CXSM10APS	
15	CXSM15-PS	Set of nos. above ⑰, ⑱ and ⑲
20	CXSM20-PS	
25	CXSM25-PS	
32	CXSM32-PS	

\* Seal kit includes ⑰, ⑱ and ⑲. Order the seal kit, based on each bore size.  
\* Since the seal kit does not include a grease pack, order it separately.  
**Grease pack part no.: GR-S-010 (10 g)**

**CX2**

**CXW**

**CXT**

**CXSJ**

**CXS**

**D-□**

**-X□**

# CXS Series

## Construction: Ball Bushing Bearing

### CXSL6

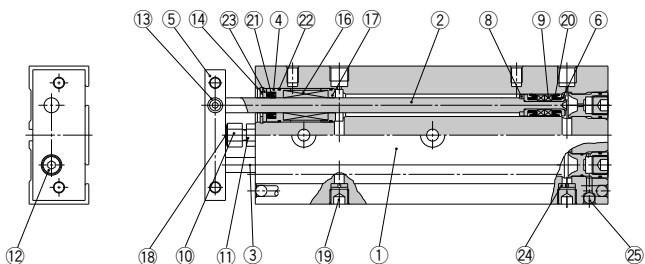

### CXSL10 to 32

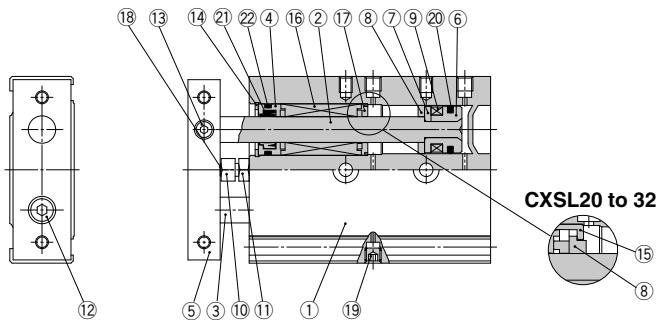

### Component Parts: Standard Piping

No.	Description	Material	Note
1	Housing	Aluminum alloy	Hard anodized
2	Piston rod A	Special steel	Hard chrome plated
3	Piston rod B	Special steel	Hard chrome plated
4	Rod cover	Aluminum bearing alloy	
5	Plate	Aluminum alloy	Anodized
6	Piston A	Aluminum alloy	Chromated
7	Piston B	Aluminum alloy	Chromated
8	Bumper	Urethane	
9	Magnet	—	
10	Bumper bolt	Carbon steel	Nickel plated
11	Hexagon nut	Carbon steel	Zinc chromated
12	Hexagon socket head cap screw	Chromium steel	Zinc chromated
13	Hexagon socket head set screw	Chromium steel	Zinc chromated
14	Retaining ring	Special steel	Phosphate coating
15	Bumper holder	Synthetic resin	

### Component Parts

No.	Description	Material	Note
16	Ball bushing	—	
17	Bearing spacer	Synthetic resin <sup>(1)</sup>	
18	Bumper	Urethane	
19	Plug	Chromium steel	Nickel plated
20	Piston seal	NBR	
21	Rod seal	NBR	
22	O-ring	NBR	
23	Seal retainer	Aluminum alloy	
24	Port spacer	Aluminum alloy	
25	Steel ball	Special steel	Hard chrome plated

Note 1) Aluminum bearing alloy for CXSL6.

### Replacement Parts/Seal Kit

Bore size (mm)	Kit no.	Contents
6	CXSL6-PS	Set of nos. above ⑳, ㉑ and ㉒
10	CXSL10BPS	
15	CXSL15APS	
20	CXSL20APS	
25	CXSL25APS	
32	CXSL32APS	

\* Seal kit includes ㉑, ㉑ and ㉒. Order the seal kit, based on each bore size.

\* Since the seal kit does not include a grease pack, order it separately.

Grease pack part no.: GR-S-010 (10 g)

Dimensions:  $\phi 6$

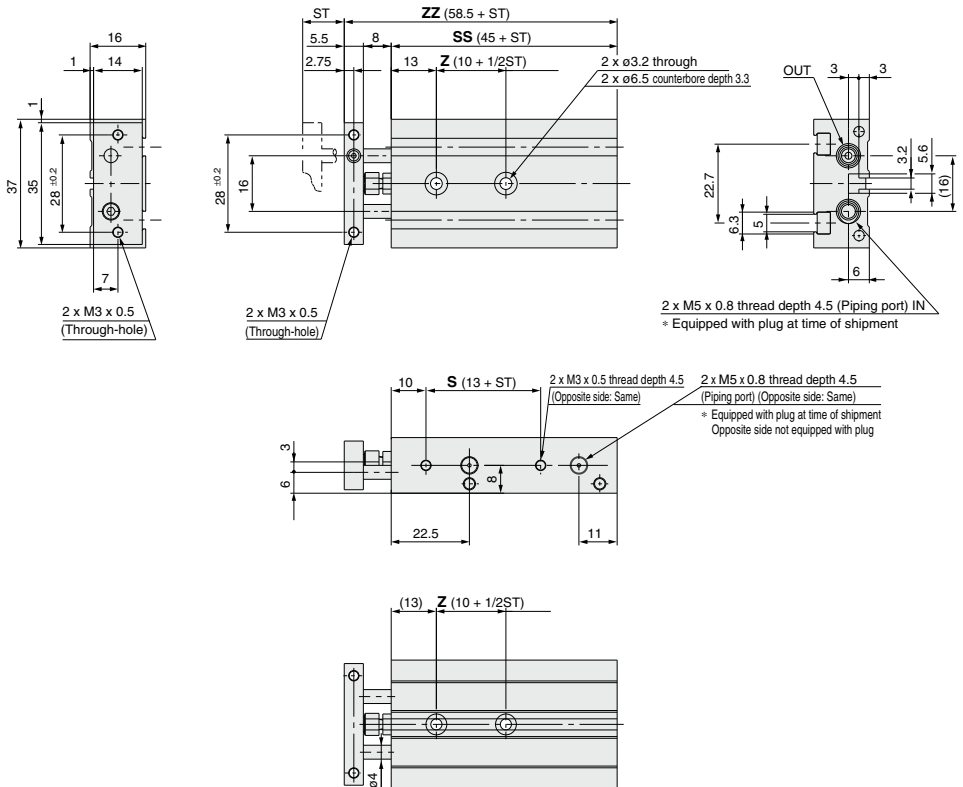

Model	Stroke	Z	S	SS	ZZ
CXS□6-10	10	15	23	55	68.5
CXS□6-20	20	20	33	65	78.5
CXS□6-30	30	25	43	75	88.5
CXS□6-40	40	30	53	85	98.5
CXS□6-50	50	35	63	95	108.5

(mm)

CX2

CXW

CXT

CXSJ

CXS

D-□

-X□

# CXS Series

Dimensions:  $\phi 10, \phi 15$

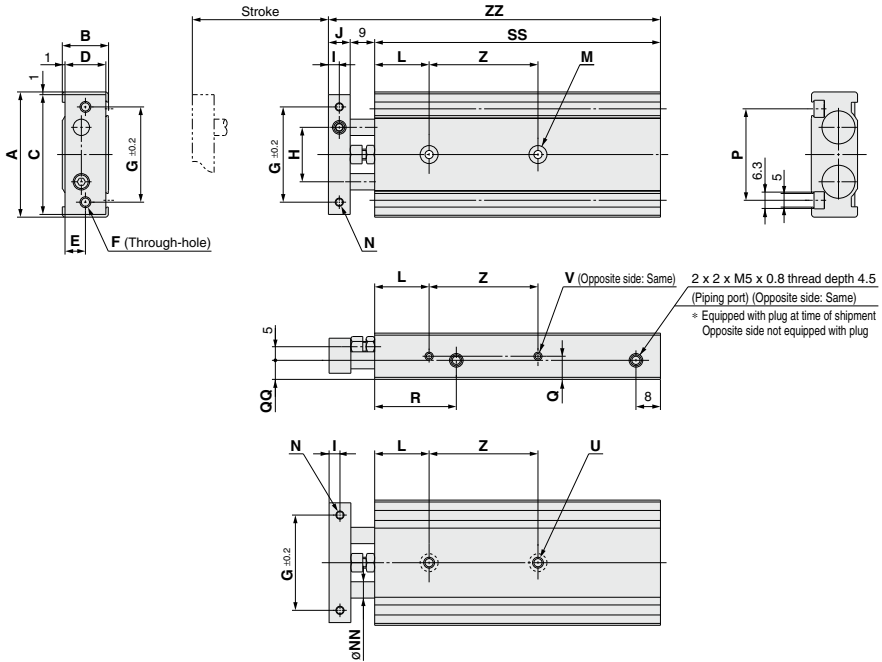

(mm)

Model	A	B	C	D	E	F	G	H	I	J	L	M	N	NN	P	Q	QQ	R	U	V
CXS□10	46	17	44	15	7.5	2 x M4 x 0.7	35	20	4	8	20	2 x $\phi 3.4$ through 2 x $\phi 6.5$ counter- bore depth 3.3	2 x M3 x 0.5 thread depth 5	$\phi 6$	33.6	8.5	7	30	2 x M4 x 0.7 thread depth 7	4 x M3 x 0.5 thread depth 4.5
CXS□15	58	20	56	18	9	2 x M5 x 0.8	45	25	5	10	30	2 x $\phi 4.3$ through 2 x $\phi 8$ counter- bore depth 4.4	2 x M4 x 0.7 thread depth 6	$\phi 8$	48	10	10	38.5	2 x M5 x 0.8 thread depth 8	4 x M4 x 0.7 thread depth 5

## Dimensions by Stroke

Symbol Stroke	SS										Z					ZZ																			
	10	15	20	25	30	35	40	45	50	60	70	75	80	90	100	10, 15, 20, 25	30, 35, 40, 45, 50	60, 70, 75	80	90, 100	10	15	20	25	30	35	40	45	50	60	70	75	80	90	100
CXS□10	65	70	75	80	85	90	95	100	105	115	125	130	-	-	-	30	40	50	-	-	82	87	92	97	102	107	112	117	122	132	142	147	-	-	-
CXS□15	70	75	80	85	90	95	100	105	110	120	130	135	140	150	160	25	35	45	45	55	89	94	99	104	109	114	119	124	129	139	149	154	159	169	179

Dimensions:  $\varnothing 20$ ,  $\varnothing 25$ ,  $\varnothing 32$

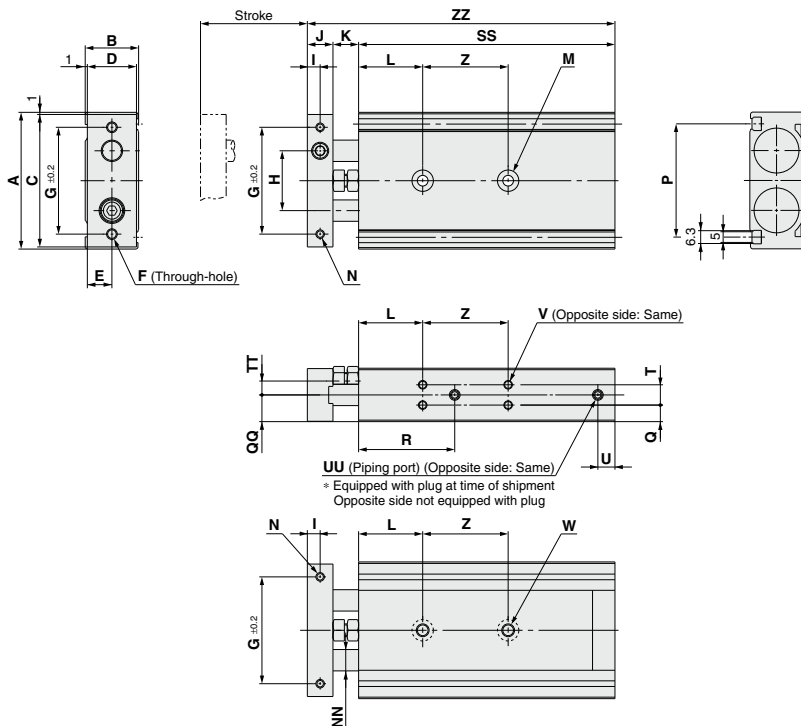

(mm)

Model	A	B	C	D	E	F	G	H	I	J	K	L	M	N	NN	P
<b>CXS</b> $\square$ <b>20</b>	64	25	62	23	11.5	2 x M5 x 0.8	50	28	6	12	12	30	2 x $\varnothing 5.5$ through 2 x $\varnothing 9.5$ counterbore depth 5.3	2 x M4 x 0.7 thread depth 6	$\varnothing 10$	53
<b>CXS</b> $\square$ <b>25</b>	80	30	78	28	14	2 x M6 x 1.0	60	35	6	12	12	30	2 x $\varnothing 6.9$ through 2 x $\varnothing 11$ counterbore depth 6.3	2 x M5 x 0.8 thread depth 7.5	$\varnothing 12$	64
<b>CXS</b> $\square$ <b>32</b>	98	38	96	36	18	2 x M6 x 1.0	75	44	8	16	14	30	2 x $\varnothing 6.9$ through 2 x $\varnothing 11$ counterbore depth 6.3	2 x M5 x 0.8 thread depth 8	$\varnothing 16$	76

Model	Q	QQ	R	T	TT	U	UU	V	W
<b>CXS</b> $\square$ <b>20</b>	7.75	12.5	45	9.5	6.5	8	4 x M5 x 0.8 thread depth 4.5	8 x M4 x 0.7 thread depth 5.5	2 x M6 x 1.0 thread depth 10
<b>CXS</b> $\square$ <b>25</b>	8.5	15	46	13	9	9	4 x Rc 1/8 thread depth 6.5	8 x M5 x 0.8 thread depth 7.5	2 x M8 x 1.25 thread depth 12
<b>CXS</b> $\square$ <b>32</b>	9	19	56	20	11.5	10	4 x Rc 1/8 thread depth 6.5	8 x M5 x 0.8 thread depth 7.5	2 x M8 x 1.25 thread depth 12

### Dimensions by Stroke

Model	SS										Z			ZZ																			
	10	15	20	25	30	35	40	45	50	60	70	75	80	90	100	10, 15, 20, 25	30, 35, 40, 45, 50	60, 70, 75, 80, 90, 100	10	15	20	25	30	35	40	45	50	60	70	75	80	90	100
<b>CXS</b> $\square$ <b>20</b>	80	85	90	95	100	105	110	115	120	130	140	145	150	160	170	30	40	60	104	109	114	119	124	129	134	139	144	154	164	169	174	184	194
<b>CXS</b> $\square$ <b>25</b>	82	87	92	97	102	107	112	117	122	132	142	147	152	162	172	30	40	60	106	111	116	121	126	131	136	141	146	156	166	171	176	186	196
<b>CXS</b> $\square$ <b>32</b>	92	97	102	107	112	117	122	127	132	142	152	157	162	172	182	40	50	70	122	127	132	137	142	147	152	157	162	172	182	187	192	202	212

**CX2**

**CXW**

**CXT**

**CXSJ**

**CXS**

**D-□**

**-X□**

# Auto Switch Mounting

## Auto Switch Proper Mounting Position (Detection at Stroke End)

Electrical entry direction:  
Inward

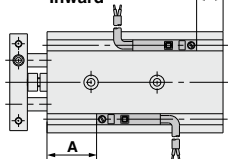

Electrical entry direction:  
Outward

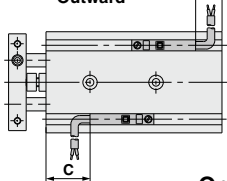

Bore size (mm)	A	B	D-Z7/Z8, D-Y7□W D-Y5□, D-Y7□		D-Y6□, D-Y7□V D-Y7□WV		D-Y7BA	
			C	D	C	D	C	D
6	15.5	4.5	11.5 (10)	0.5 (-1)	13	2	5.5	-5.5
10	22.5	7.5	18.5 (17)	3.5 (2)	20	5	12.5	-2.5
15	30.5	4.5	26.5 (25)	0.5 (-1)	28	2	20.5	-5.5
20	38	7	34 (32.5)	3 (1.5)	36	4.5	28	-3
25	38	9	34 (32.5)	5 (3.5)	36	6.5	28	-1
32	48	9	44 (42.5)	5 (3.5)	46	6.5	38	-1

Note 1) Negative figures in the table D indicate how much the load wires protrude from the cylinder body.

Note 2) ( ): Denotes the dimensions of D-Z7.

Note 3) Adjust the auto switch after confirming the operating conditions in the actual setting.

## Operating Range

Auto switch model	Bore size (mm)					
	6	10	15	20	25	32
D-Z7□/Z80	9	7	9	9	9	11
D-Y59□, D-Y69□ D-Y7P/Y7PV D-Y7□W/Y7□WV D-Y7BA	3	3	3.5	3.5	4	4.5

\* Since this is a guideline including hysteresis, not meant to be guaranteed.

(assuming approximately ±30% dispersion.)

There may be the case it will vary substantially depending on an ambient environment.

## Dimensions for Mounting of Auto Switch

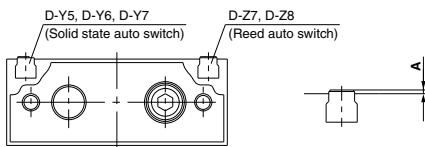

## A Dimension

Auto switch model	Bore size (mm)					
	6	10	15	20	25	32
D-Y59A/Y7P/Y59B D-Y69A/Y7PV/Y69B D-Z7NWV/Y7PWV/Y7BWW D-Z7NW/Y7PW/Y7BW D-Y7BA	0.7		0.2			
D-Z7, D-Z8	1.2		0.7			

## Auto Switch Mounting

When mounting and securing auto switches, they should be inserted into the cylinder's auto switch mounting rail from the direction shown in the drawing below.

After setting in the mounting position, use a flat head watchmaker's screwdriver to tighten the auto switch mounting screw that is included.

Note) When tightening an auto switch mounting screw, use a watchmaker's screwdriver with a handle of approximately 5 to 6 mm in diameter. Also, tighten with a torque of about 0.05 to 0.1 N·m. As a guide, turn about 90° past the point at which tightening can first be felt.

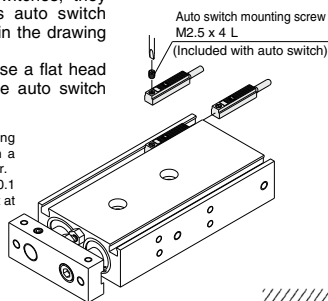

## Caution

### 1. Avoid proximity to magnetic objects

When magnetic substances such as iron (including flange brackets) are in close proximity to a cylinder body with an auto switch, be sure to provide a clearance between the magnetic substance and the cylinder body as shown in the drawing below. If the clearance is less than the values noted in the table below, the auto switch may not function properly.

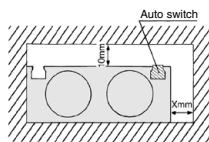

Bore size	X (mm)
ø6	0
ø10	0
ø15	10
ø20	10
ø25	0
ø32	0

Other than the applicable auto switches listed in "How to Order", the following auto switches can be mounted. For detailed specifications, refer to pages 1119 to 1245.

\* Normally closed (NC = b contact), solid state auto switch (D-Y7G/Y7H type) are also available. For details, refer to page 1139.



## 1 Without Plate

Symbol

**-X593**

CXS  Bore size -  Stroke -  Auto switch - X593

Without plate

This specification is for the cylinder without a plate. This cylinder is suitable for mounting your own plate. Please note that the rod end dimensions of this cylinder are different from those of the standard cylinder.

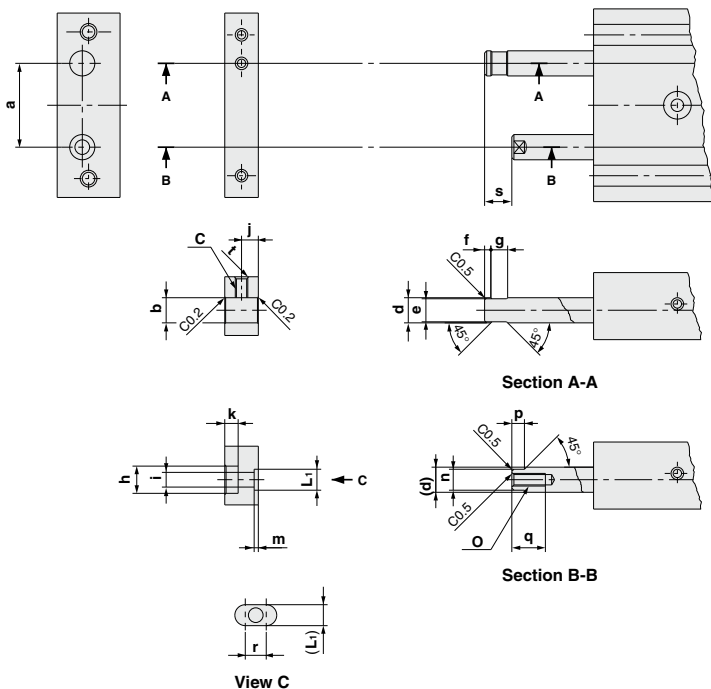

Section A-A

Section B-B

View C

Model	a	b	c	d	e	f	g	h	i	j	k	L <sub>1</sub>	m	n	o	p	q	r	s	t	(mm)
CXS□6	16 <sup>+0.1</sup>	ø4 <sup>+0.013</sup> <sub>-0.001</sub>	M3 x 0.5	ø4	ø3.5	1	3	ø5.5	ø6 <sup>0</sup> <sub>-0.2</sub>	2.75	2.8 <sup>+0.2</sup>	3.5 <sup>+0.1</sup>	0.5 <sup>+0.2</sup>	3.5 <sup>-0.05</sup> <sub>-0.15</sub>	M2.5 x 0.45	3	4.5	3.5	4.75	C0.5	
CXS□10	20 <sup>+0.1</sup>	ø6 <sup>+0.016</sup> <sub>-0.001</sub>	M5 x 0.8	ø6	ø5.5	1.25	4.5	ø6.5	ø3.5 <sup>0</sup> <sub>-0.2</sub>	4	3.2 <sup>+0.2</sup>	5 <sup>+0.1</sup>	1 <sup>+0.2</sup>	5 <sup>-0.05</sup> <sub>-0.15</sub>	M3 x 0.5		8	5	6.5	C0.5	
CXS□15	25 <sup>+0.1</sup>	ø8 <sup>+0.016</sup> <sub>-0.001</sub>	M6 x 1.0	ø8	ø7.5	2	5	ø9.5	ø5.5 <sup>0</sup> <sub>-0.2</sub>	5	5.2 <sup>+0.3</sup>	6 <sup>+0.2</sup>	1.5 <sup>+0.2</sup>	6 <sup>-0.05</sup> <sub>-0.15</sub>	M5 x 0.8		8	7	8	C0.5	
CXS□20	28 <sup>+0.1</sup>	ø10 <sup>+0.016</sup> <sub>-0.001</sub>	M8 x 1.25	ø10	ø9.5	2	7	ø11	ø6.6 <sup>0</sup> <sub>-0.2</sub>	6	6.2 <sup>+0.3</sup>	8 <sup>+0.2</sup>	2 <sup>+0.2</sup>	8 <sup>-0.05</sup> <sub>-0.15</sub>	M6 x 1.0		10	8	9.5	C0.5	
CXS□25	35 <sup>+0.1</sup>	ø12 <sup>+0.019</sup> <sub>-0.001</sub>	M8 x 1.25	ø12	ø11.5	2	7	ø11	ø6.6 <sup>0</sup> <sub>-0.2</sub>	6	6.2 <sup>+0.3</sup>	10 <sup>+0.2</sup>	2 <sup>+0.2</sup>	10 <sup>-0.05</sup> <sub>-0.15</sub>	M6 x 1.0		12	8.5	9.5	C0.7	
CXS□32	44 <sup>+0.1</sup>	ø16 <sup>+0.019</sup> <sub>-0.001</sub>	M10 x 1.5	ø16	ø15.5	3.5	8	ø14	ø9 <sup>0</sup> <sub>-0.2</sub>	8	8.2 <sup>+0.4</sup>	13 <sup>+0.2</sup>	2 <sup>+0.2</sup>	13 <sup>-0.05</sup> <sub>-0.15</sub>	M8 x 1.25	12.5	11	13.5	C0.7		

Note 1) Unless indicated otherwise, the dimensional tolerance conforms to the ordinary dimensional difference (matching) per JIS B 0405.

Note 2) Piston rod A and B must be extended in order to install a plate. Apply pressure (0.2 MPa or more) from the supply port of the extended end when installing a plate.

To secure the plate to the rods, attach it first to piston rod B, and then to piston rod A. Make sure to apply Loctite to the threaded portion.

After anchoring the plate, operate the cylinder to check for proper operation (e.g., the cylinder operates smoothly when moved by hand or at least operates properly at the minimum operating pressure).

CX2

CXW

CXT

CXSJ

CXS

D-□

-X□



# CXS Series

## Specific Product Precautions

Be sure to read this before handling the products.

Refer to back page 50 for Safety Instructions and pages 3 to 12 for Actuator and Auto Switch Precautions.

### Mounting

#### ⚠ Caution

1. **Make sure that the surface on which the cylinder is to be mounted is flat (reference value for flatness: 0.05 or less).**

Dual rod cylinders can be mounted from 3 directions, however, make sure that the surface on which the cylinder is to be mounted is flat (reference value for flatness: 0.05 or less). Otherwise, the accuracy of the piston rod operation is not achieved, and malfunctioning can occur.

2. **Piston rod must be retracted when mounting the cylinder.**

Scratches or gouges in the piston rod may lead to damaged bearings and seals and cause malfunctions or air leakage.

### Piping

#### ⚠ Caution

1. **Plug the appropriate supply port(s) according to the operating conditions.**

Dual-rod cylinders have 2 supply ports for each operating direction (3 supply ports for ø6 only). Plug the appropriate supply port according to the operating conditions. When changing the port position, use the removed plug or a new plug. If reusing the removed plug, apply sealant, etc., before reassembly. If using a new M5 plug, apply a thin layer of grease all the way around the male thread before use. In addition, clear any foreign matter adhered to the port the plug was removed from before piping.

After reassembly, be sure to check for air leakage before operating the product.

Plug part no.: (ø6)CXS10-08-28747B  
 (ø10 to ø20)CXS20-08-28749A  
 (ø25 to ø32)CYP025-08B29449(Rc 1/8)  
 CXS25-08-A3025A(NPT 1/8)  
 CXS25-08-A3911(G 1/8)

### Stroke Adjustment

#### ⚠ Caution

1. **After adjusting the stroke, make sure to tighten the hexagon nut to prevent it from loosening.**

Dual rod cylinders have a bolt to adjust 0 to -5 mm strokes on the retracted end (IN).

Loosen the hexagon nut to adjust the stroke; however, make sure to tighten the hexagon nut after making an adjustment.

2. **Never operate a cylinder with its bumper bolt removed. Also, do not attempt to tighten the bumper bolt without using a nut.**

If the bumper bolt is removed, the piston hits the head cover causing damage to the cylinder. Therefore, do not use a cylinder without a bumper bolt.

Furthermore, if the bumper bolt is tightened without a nut, the piston seal is caught in the leveled part, damaging the seal.

### Stroke Adjustment

#### ⚠ Caution

3. **A bumper at the end of the bumper bolt is replaceable.**

In case a missing bumper, or a bumper has a permanent settling, use following part numbers for ordering.

Bore size (mm)	6, 10, 15	20, 25	32
Part no.	CXS10-34A 28747	CXS20-34A 28749	CXS32-34A 28751
Qty.	1		

### Disassembly and Maintenance

#### ⚠ Caution

1. **Never use a cylinder with its plate removed.**

When removing the hexagon socket head cap screw on the end plate, the piston rod must be secured to prevent from rotating. However, if the sliding parts of the piston rod are scratched and gouged, a malfunction may occur. If the plate is not required for your application, use the cylinder that does not come with a plate, available through made-to-order (-X593) on page 759.

2. **When disassembling and reassembling the cylinder, please contact SMC or refer to the separate operation manual.**

#### ⚠ Warning

1. **Take precautions when your hands are near the plate and housing.**

Take sufficient care to avoid getting your hands or fingers caught when the cylinder is operated.

### Operating Environment

#### ⚠ Caution

1. **Do not operate the cylinder in a pressurized environment.**

The pressurized air may flow inside the cylinder due to its construction.

2. **Do not use as a stopper. This may cause malfunction.**

When using as a stopper, select a stopper cylinder (RS series) or a compact guide cylinder (MGP series).

### Speed Adjustment

#### ⚠ Caution

1. **A sudden extension may occur with CXS□6.**

CXS□6 has a low internal volume and sudden extension/erratic movement may occur particularly when it is used at low speed. This sudden extension can be mitigated by combining the use of meter-in and meter-out speed controllers.



# Dual Rod Cylinder With Air Cushion

# CXS Series

ø20, ø25, ø32



## How to Order

Thread type		
Symbol	Type	Bore size
Nil	M thread	ø20
	Rc	
TN	NPT	ø25, ø32
TF	G	

**CXS M 20** - **100** A - **Y7BW**

Dual Rod Cylinder

Bearing type

M	Slide bearing
L	Ball bushing bearing

Bore size/Stroke (mm)

Bore size	Stroke
20	20, 25, 30, 35, 40, 45, 50, 60, 70, 75, 80, 90, 100
25, 32	25, 30, 35, 40, 45, 50, 60, 70, 75, 80, 90, 100

Number of auto switches  
(No. of auto switch)

Nil	2 pcs.
S	1 pc.
n	"n" pcs.

Auto switch

Nil Without auto switch (Built-in magnet)

\* For the applicable auto switch model, refer to the table below.

Air cushion

## Applicable Auto Switches/Refer to pages 1119 to 1245 for further information on auto switches.

Type	Special function	Electrical entry	Indicator light	Wiring (Output)	Load voltage		Auto switch model		Lead wire length (m) *			Pre-wired connector	Applicable load		
					DC	AC	Perpendicular	In-line	0.5 (Nil)	3 (L)	5 (Z)		IC circuit	Relay, PLC	
															Y69A
Solid state auto switch	—	Grommet	Yes	3-wire (NPN)	24 V	5 V, 12 V	—	Y69A	Y59A	●	●	○	○	IC circuit	Relay, PLC
				3-wire (PNP)				Y7PV	Y7P	●	●	○	○		
	2-wire			Y69B				Y59B	●	○	○	○	—		
	3-wire (NPN)			Y7NWV				Y7NW	●	●	○	○	IC circuit		
	3-wire (PNP)			Y7PVV				Y7PW	●	●	○	○	IC circuit		
Reed auto switch	—	Grommet	Yes	3-wire (NPN equivalent)	24 V	12 V	—	—	Z76	●	●	—	—	IC circuit	—
				—				Z73	●	●	—	—	—	—	Relay, PLC
				2-wire				Z80	●	●	—	—	—	—	IC circuit

\*\* Water resistant type auto switches can be mounted on the above models, but in such case SMC cannot guarantee water resistance.

Consult with SMC regarding water resistant types with the above model numbers.

\* Lead wire length symbols: 0.5 m ..... Nil (Example) Y59A  
3 m ..... L (Example) Y59AL  
5 m ..... Z (Example) Y59AZ

\* Solid state auto switches marked with "○" are produced upon receipt of order.

- Since there are other applicable auto switches than listed, refer to page 758 for details.
- For details about auto switches with pre-wired connector, refer to pages 1192 and 1193.
- Auto switches are shipped together (not assembled).

### Moisture Control Tube IDK Series



When operating an actuator with a small diameter and a short stroke at a high frequency, the dew condensation (water droplet) may occur inside the piping depending on the conditions.

Simply connecting the moisture control tube to the actuator will prevent dew condensation from occurring. For details, refer to [the IDK series in the Best Pneumatics No. 6](#).

CX2

CXW

CXT

CXSJ

CXS

D-□

-X□

## ⚠ Precautions

Be sure to read this before handling the products.

Refer to back page 50 for Safety Instructions and pages 3 to 12 for Actuator and Auto Switch Precautions.

## Selection

## ⚠ Caution

- Operate the cylinder until the stroke end. If the stroke is restricted by the external stopper and clamp workpiece, effective cushioning and noise reduction will not be achieved.
- Adjust the cushion needles to absorb the kinetic energy during the cushion stroke so that excessive kinetic energy does not remain when the piston reaches the stroke end.

If the piston reaches the stroke end with excessive kinetic energy remaining (more than the values given in table (1) below) due to an improper adjustment, excessive impact will occur, causing damage to machinery.

Table (1) Allowable Value at Piston Impact

Bore size (mm)	20	25	32
Piston speed (mm/s)	50 to 700	50 to 600	50 to 600
Kinetic energy (J)	0.17	0.27	0.32

## Cushion Needle Adjustment

## ⚠ Caution

- Keep the adjusting range for the cushion needle between the fully closed position and the rotations shown below.

Bore size (mm)	20	25	32
Rotations	2.5 rotations or less	3 rotations or less	

Use a 3 mm flat head watchmakers screwdriver to adjust the cushion needles to the fully closed position, as this will cause damage to the seals. The adjusting range for the cushion needles must be between the fully closed position and the open position ranges indicated in the table above. A retaining mechanism prevents the cushion needles from slipping out; however, they may spring out during operation if they are rotated beyond the ranges shown above.

Precautions for selection standard, mounting, piping, and operating environment are same as for the standard series.

## Specifications

Bore size (mm)	20	25	32
Fluid	Air (Non-lube)		
Proof pressure	1.05 MPa		
Maximum operating pressure	0.7 MPa		
Minimum operating pressure	0.1 MPa		
Ambient and fluid temperature	-10 to 60°C (No freezing)		
Piston speed	50 to 1000 mm/s		
Port size	M5 x 0.8	Rc 1/8 (NPT 1/8, G 1/8)	
Bearing type	Slide bearing, Ball bushing bearing (Same dimensions for both)		
Cushion	Air cushion (Both ends)		

## Cushion mechanism

Bore size (mm)	Effective cushion length (mm)	Absorbable kinetic energy (J)
20	5.9	0.40
25	5.7	0.75
32	5.6	1.0

\* Maximum load mass is the same as the standard type.

## Standard Stroke

Model	Standard stroke (mm)
CXS□20	20, 25, 30, 35, 40, 45, 50, 60, 70, 75, 80, 90, 100
CXS□25 CXS□32	25, 30, 35, 40, 45, 50, 60, 70, 75, 80, 90, 100

## Theoretical Output

Model	Rod size (mm)	Operating direction	Piston area (mm <sup>2</sup> )	Operating pressure (MPa)							
				0.1	0.2	0.3	0.4	0.5	0.6	0.7	
CXS□20	10	OUT	628	62.8	126	188	251	314	377	440	
		IN	471	47.1	94.2	141	188	236	283	330	
CXS□25	12	OUT	982	98.2	196	295	393	491	589	687	
		IN	756	75.6	151	227	302	378	454	529	
CXS□32	16	OUT	1608	161	322	482	643	804	965	1126	
		IN	1206	121	241	362	482	603	724	844	

Note) Theoretical output (N) = Pressure (MPa) x Piston area (mm<sup>2</sup>)

## Weight

Model	Standard stroke (mm)												
	20	25	30	35	40	45	50	60	70	75	80	90	100
CXSM20-□A	0.50	0.52	0.54	0.56	0.58	0.60	0.62	0.66	0.70	0.715	0.735	0.755	0.815
CXSL20-□A	0.52	0.54	0.56	0.58	0.60	0.62	0.64	0.68	0.72	0.735	0.755	0.775	0.835
CXSM25-□A	—	0.78	0.80	0.82	0.84	0.86	0.88	0.92	0.96	0.98	1.00	1.04	1.08
CXSL25-□A	—	0.79	0.81	0.83	0.85	0.87	0.89	0.93	0.97	0.99	1.01	1.05	1.09
CXSM32-□A	—	1.48	1.53	1.575	1.62	1.67	1.72	1.82	1.92	1.96	2.06	2.14	2.20
CXSL32-□A	—	1.51	1.55	1.60	1.64	1.69	1.74	1.84	1.94	1.98	2.08	2.16	2.22

## Construction

### CXSM/With air cushion

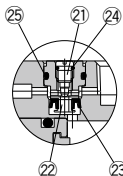
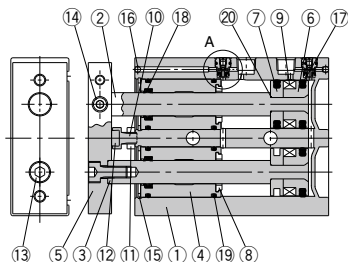

Close-up of A

### CXSL/With air cushion

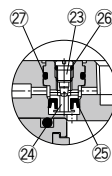
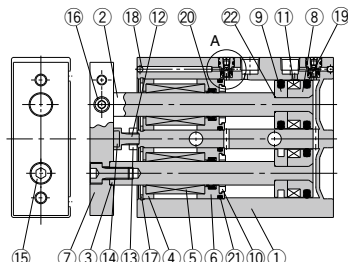

Close-up of A

### Component Parts: CXSM

No.	Description	Material	Note
1	Housing	Aluminum alloy	Hard anodized
2	Piston rod A	Carbon steel	Hard chrome plated
3	Piston rod B	Carbon steel	Hard chrome plated
4	Rod cover	Aluminum bearing alloy	
5	Plate	Aluminum alloy	Anodized
6	Piston A	Aluminum alloy	Chromated
7	Piston B	Aluminum alloy	Chromated
8	Bumper B	Urethane	
9	Magnet	—	
10	Bumper bolt	Carbon steel	Nickel plated
11	Hexagon nut	Carbon steel	Zinc chromated
12	Bumper	Urethane	
13	Hexagon socket head cap screw	Chromium steel	Zinc chromated
14	Hexagon socket head set screw	Chromium steel	Zinc chromated
15	Retaining ring	Special steel	Phosphate coated
16	Steel ball	Special steel	Nickel plated
17	Piston seal	NBR	
18	Rod seal	NBR	
19	O-ring	NBR	
20	O-ring	NBR	
21	Cushion needle	Stainless steel	
22	Check seal retainer	Copper alloy	
23	Check seal	NBR	
24	Needle gasket	NBR	
25	Check gasket	NBR	

### Component Parts: CXSL

No.	Description	Material	Note
1	Housing	Aluminum alloy	Hard anodized
2	Piston rod A	Special steel	Hard chrome plated
3	Piston rod B	Special steel	Hard chrome plated
4	Bearing spacer	Aluminum alloy	
5	Ball bushing	—	
6	Bumper holder	Aluminum alloy	
7	Plate	Aluminum alloy	Anodized
8	Piston A	Aluminum alloy	Chromated
9	Piston B	Aluminum alloy	Chromated
10	Bumper B	Urethane	
11	Magnet	—	
12	Bumper bolt	Carbon steel	Nickel plated
13	Hexagon nut	Carbon steel	Zinc chromated
14	Bumper	Urethane	
15	Hexagon socket head cap screw	Chromium steel	Zinc chromated
16	Hexagon socket head set screw	Chromium steel	Zinc chromated
17	Retaining ring	Special steel	Phosphate coated
18	Steel ball	Special steel	Nickel plated
19	Piston seal	NBR	
20	Rod seal	NBR	
21	O-ring	NBR	
22	O-ring	NBR	
23	Cushion needle	Stainless steel	
24	Check seal retainer	Copper alloy	
25	Check seal	NBR	
26	Needle gasket	NBR	
27	Check gasket	NBR	

### Replacement Parts/Seal Kit

Bore size (mm)	Kit no.	Contents
20	CXS□20A-PS	CXSM: Set of nos. 17, 18 and 19 CXSL: Set of nos. 19, 20 and 21
25	CXS□25A-PS	
32	CXS□32A-PS	

\* Seal kit includes 17, 18 and 19. Order the seal kit, based on each bore size.  
\* Since the seal kit does not include a grease pack, order it separately.  
**Grease pack part no.: GR-S-010 (10 g)**

**CX2**

**CXW**

**CXT**

**CXSJ**

**CXS**

**D-□**

**-X□**

# CXS Series

Dimensions:  $\phi 20$

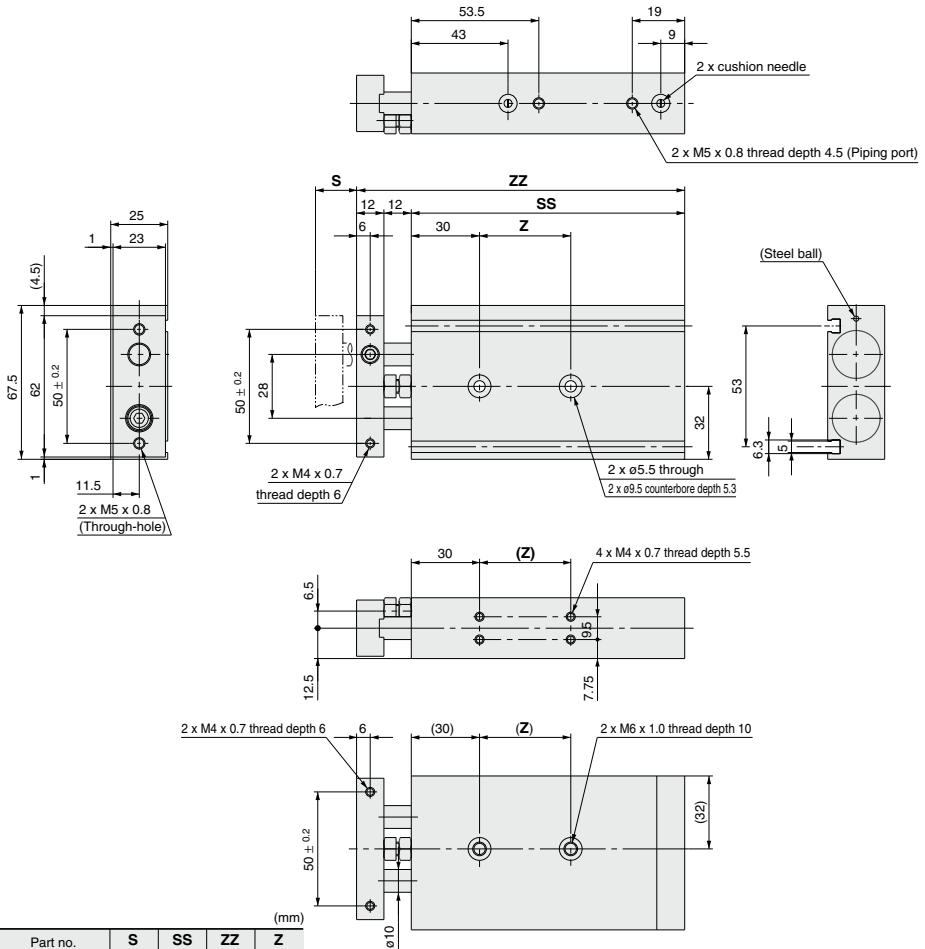

Part no.	S	SS	ZZ	Z
CXS□20-20A	20	92	116	30
CXS□20-25A	25	97	121	
CXS□20-30A	30	102	126	
CXS□20-35A	35	107	131	40
CXS□20-40A	40	112	136	
CXS□20-45A	45	117	141	
CXS□20-50A	50	122	146	60
CXS□20-60A	60	132	156	
CXS□20-70A	70	142	166	
CXS□20-75A	75	147	171	
CXS□20-80A	80	152	176	
CXS□20-90A	90	162	186	
CXS□20-100A	100	172	196	

Dimensions:  $\phi 25$

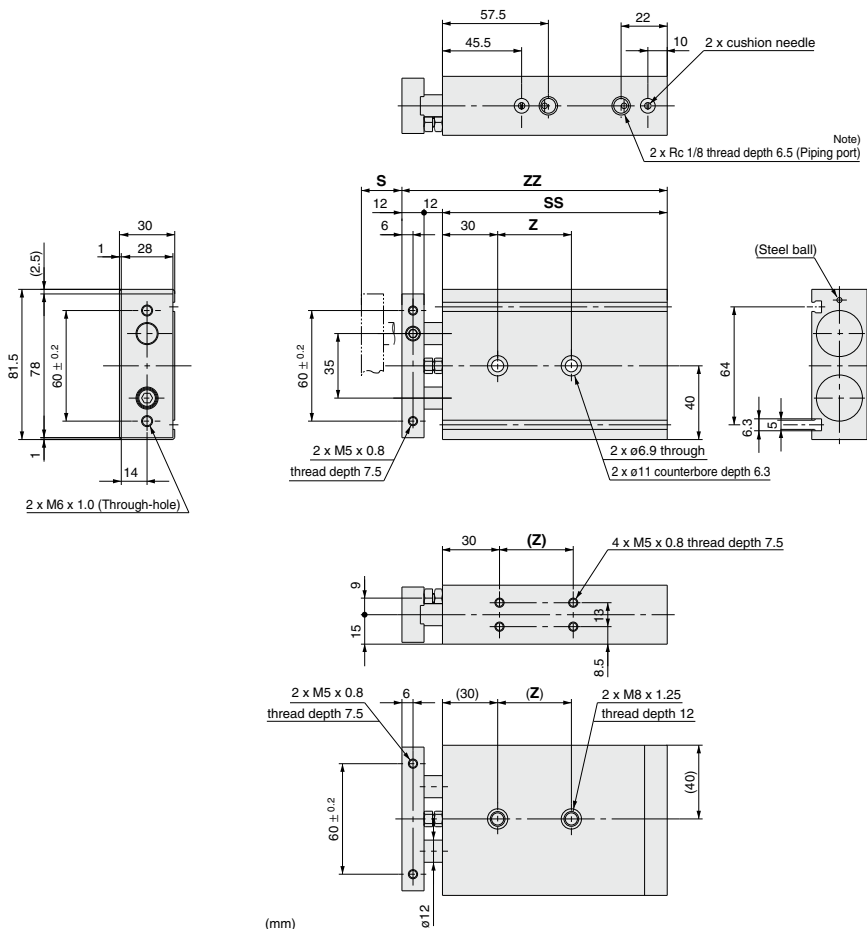

(mm)

Part no.	S	SS	ZZ	Z
CXS□25-25A	25	100	124	30
CXS□25-30A	30	105	129	
CXS□25-35A	35	110	134	
CXS□25-40A	40	115	139	40
CXS□25-45A	45	120	144	
CXS□25-50A	50	125	149	
CXS□25-60A	60	135	159	
CXS□25-70A	70	145	169	
CXS□25-75A	75	150	174	60
CXS□25-80A	80	155	179	
CXS□25-90A	90	165	189	
CXS□25-100A	100	175	199	

Note) For port threads TN and TF, only the piping port type varies.

CX2

CXW

CXT

CXSJ

CXS

D-□

-X□

# CXS Series

Dimensions:  $\phi 32$

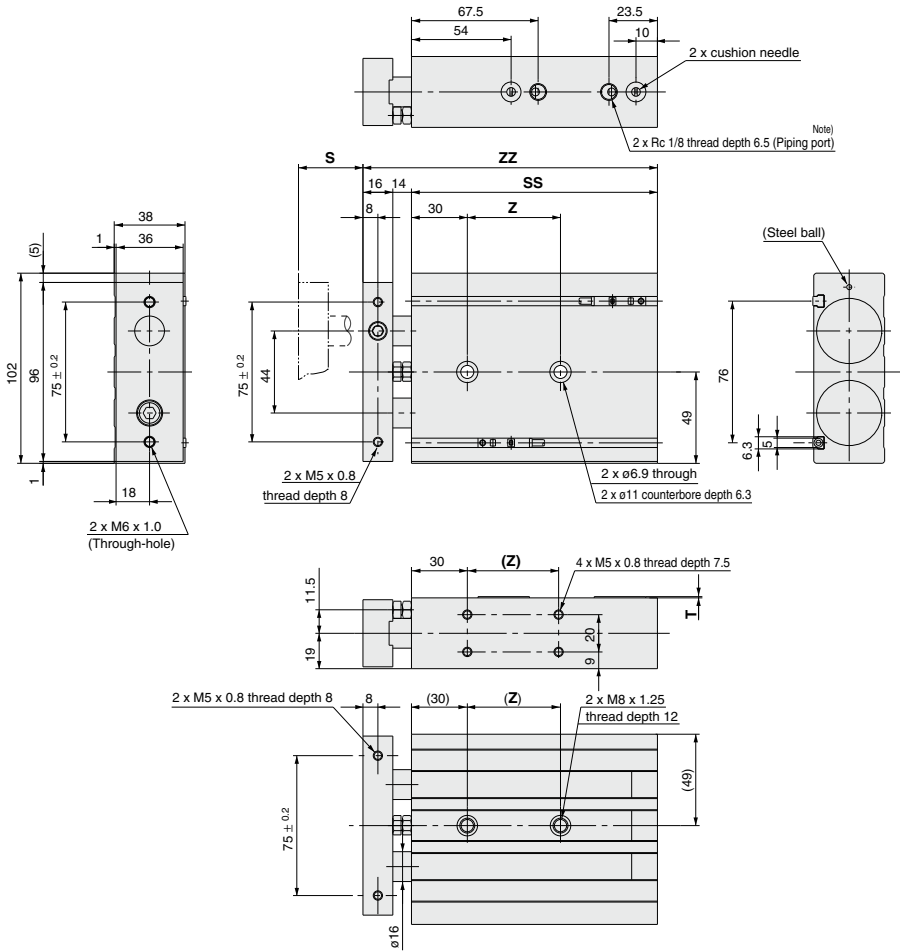

Part no.	S	SS	ZZ	Z
CXS□32-25A	25	112	142	40
CXS□32-30A	30	117	147	50
CXS□32-35A	35	122	152	
CXS□32-40A	40	127	157	70
CXS□32-45A	45	132	162	
CXS□32-50A	50	137	167	
CXS□32-60A	60	147	177	
CXS□32-70A	70	157	187	70
CXS□32-75A	75	162	192	
CXS□32-80A	80	167	197	
CXS□32-90A	90	177	207	
CXS□32-100A	100	187	217	

Note) For port threads TN and TF, only the piping port type varies.

# Auto Switch Mounting

## Auto Switch Proper Mounting Position (Detection at Stroke End)

Electrical entry direction: Inward

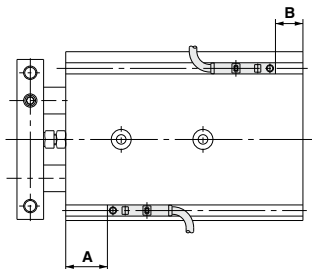

Electrical entry direction: Outward

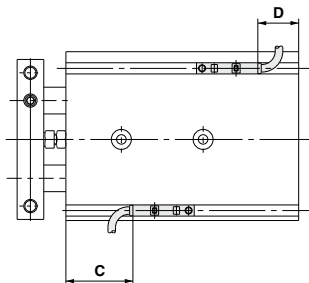

Bore size (mm)	A	B	D-Z7/Z8, D-Y7□W D-Y5□, D-Y7□		D-Y6□, D-Y7□V D-Y7□WV		D-Y7BA	
			C	D	C	D	C	D
20	40.5	6.5	36.5(35)	2.5(1)	38.5	4	30.5	-3.5
25	42	8	38(36.5)	4(2.5)	40	5.5	32	-2
32	52.5	9.5	48.5(47)	5.5(4)	50.5	7	42.5	-0.5

Note) Adjust the auto switch after confirming the operating conditions in the actual setting.

As for auto switch mounting dimensions, auto switch mounting method and its operating range, those are the same as basic type. Refer to page 758.

CX2

CXW

CXT

CXSJ

CXS

D-□

-X□

# Dual Rod Cylinder With End Lock for Retraction Side

## CXS Series

ø6, ø10, ø15, ø20, ø25, ø32

### How to Order

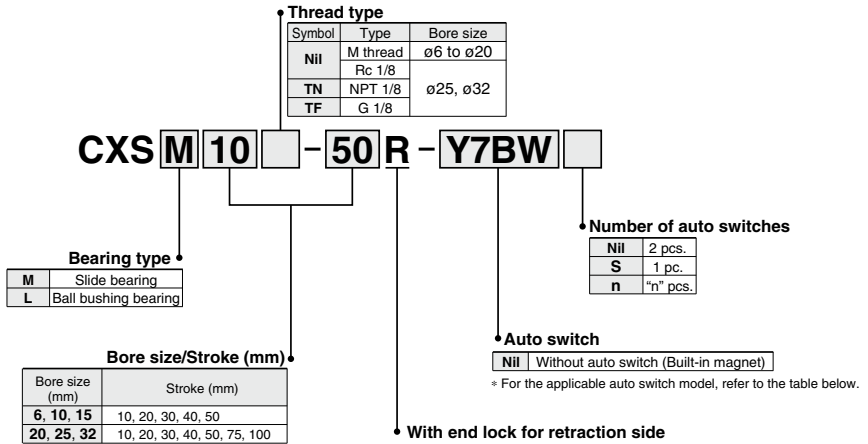

### Applicable Auto Switches

Refer to pages 1119 to 1245 for further information on auto switches.

Type	Special function	Electrical entry	Indicator light	Wiring (Output)	Load voltage		Auto switch model		Lead wire length (m)*			Pre-wired connector	Applicable load	
					DC	AC	Perpendicular	In-line	0.5 (Nil)	3 (L)	5 (Z)		IC circuit	Relay, PLC
Solid state auto switch	—	Grommet	Yes	3-wire (NPN)	5 V, 12 V	—	Y69A	Y59A	●	●	○	○	Relay, PLC	
				3-wire (PNP)			Y7PV	Y7P	●	●	○	○		
				2-wire	Y69B		Y59B	●	●	○	○			
	3-wire (NPN)			5 V, 12 V	Y7NWV		Y7NW	●	●	○	○			
	3-wire (PNP)			12 V	Y7PWV		Y7PW	●	●	○	○			
Diagnostic indication (2-color indicator)	Water resistant (2-color indicator)	2-wire	2-wire	12 V	—	—	Y7BWV	Y7BW	●	●	○	○	—	
							—	Y7BA**	—	●	○	○		
							—	—	—	—	—	—		—
Reed auto switch	—	Grommet	Yes	3-wire (NPN equivalent)	—	5 V	—	Z76	●	●	—	—	IC circuit	—
				2-wire	24 V	12 V	100 V	—	Z73	●	●	—	—	Relay, PLC
								100 V or less	—	Z80	●	●	—	—

\*\* Water resistant type auto switches can be mounted on the above models, but in such case SMC cannot guarantee water resistance.

Consult with SMC regarding water resistant types with the above model numbers.

\* Lead wire length symbols: 0.5 m ..... Nil (Example) Y59A  
 3 m ..... L (Example) Y59AL  
 5 m ..... Z (Example) Y59AZ

\* Solid state auto switches marked with "○" are produced upon receipt of order.

- Since there are other applicable auto switches than listed, refer to page 758 for details.
- For details about auto switches with pre-wired connector, refer to pages 1192 and 1193.
- Auto switches are shipped together (not assembled).



# Dual Rod Cylinder **CXS Series**

With End Lock for Retraction Side



## Specifications

Bore size (mm)	6	10	15	20	25	32
Fluid	Air (Non-lube)					
Proof pressure	1.05 MPa					
Maximum operating pressure	0.7 MPa					
Minimum operating pressure	0.3 MPa					
Ambient and fluid temperature	-10 to 60°C (No freezing)					
Piston speed	30 to 300mm/s	30 to 800mm/s	30 to 700mm/s	30 to 600mm/s		
Cushion	Bumper is standard on both ends					
Port size	M5 x 0.8				Rc 1/8	
Bearing type	Slide bearing, Ball bushing bearing (Same dimensions for both)					
Allowable kinetic energy	0.0023 J	0.064 J	0.095 J	0.17 J	0.27 J	0.32 J

## Lock Specifications

Lock specifications	Rear end lock					
Bore size (mm)	6	10	15	20	25	32
Maximum holding force (N)	14.7	39.2	98.1	157	235	382
Manual release	Non-lock type					

\* Maximum load mass is the same as the standard type.

## Standard Stroke

Model	Standard stroke (mm)
CXS□6	10, 20, 30, 40, 50
CXS□10	
CXS□15	
CXS□20	
CXS□25	10, 20, 30, 40, 50, 75, 100
CXS□32	

\* Strokes which exceed the standard stroke length will be available as special goods.

## Theoretical Output

Model	Rod size (mm)	Operating direction	Piston area (mm <sup>2</sup> )	Operating pressure (MPa)							
				0.1	0.15	0.2	0.3	0.4	0.5	0.6	0.7
				CXS□6	4	OUT	56	—	8.4	11.2	16.8
		IN	31	—	4.6	6.2	9.3	12.4	15.5	18.6	21.7
CXS□10	6	OUT	157	15.7	—	31.4	47.1	62.8	78.5	94.2	110
		IN	100	10.0	—	20.0	30.0	40.0	50.0	60.0	70.0
CXS□15	8	OUT	353	35.3	—	70.6	106	141	177	212	247
		IN	252	25.2	—	50.4	75.6	101	126	151	176
CXS□20	10	OUT	628	62.8	—	126	188	251	314	377	440
		IN	471	47.1	—	94.2	141	188	236	283	330
CXS□25	12	OUT	982	98.2	—	196	295	393	491	589	687
		IN	756	75.6	—	151	227	302	378	454	529
CXS□32	16	OUT	1608	161	—	322	482	643	804	965	1126
		IN	1206	121	—	241	362	482	603	724	844

(Note) Theoretical output (N) = Pressure (MPa) x Piston area (mm<sup>2</sup>)

## Weight

Model	Standard stroke (mm)						
	10	20	30	40	50	75	100
CXSM6-□R	0.105	0.12	0.135	0.15	0.165	—	—
CXSL6-□R	0.105	0.12	0.135	0.15	0.165	—	—
CXSM10-□R	0.18	0.2	0.225	0.25	0.27	—	—
CXSL10-□R	0.18	0.2	0.225	0.25	0.27	—	—
CXSM15-□R	0.3	0.33	0.355	0.38	0.41	—	—
CXSL15-□R	0.32	0.35	0.375	0.4	0.43	—	—
CXSM20-□R	0.465	0.5	0.54	0.58	0.62	0.715	0.815
CXSL20-□R	0.485	0.52	0.56	0.60	0.64	0.735	0.835
CXSM25-□R	0.72	0.76	0.8	0.84	0.88	0.98	1.08
CXSL25-□R	0.73	0.77	0.81	0.85	0.89	0.99	1.09
CXSM32-□R	1.33	1.43	1.53	1.62	1.72	1.96	2.2
CXSL32-□R	1.35	1.45	1.55	1.64	1.74	1.98	2.22

### Moisture Control Tube IDK Series



When operating an actuator with a small diameter and a short stroke at a high frequency, the dew condensation (water droplet) may occur inside the piping depending on the conditions.

Simply connecting the moisture control tube to the actuator will prevent dew condensation from occurring. For details, refer to [the IDK series in the Best Pneumatics No. 6.](#)

# CXS Series

## Construction

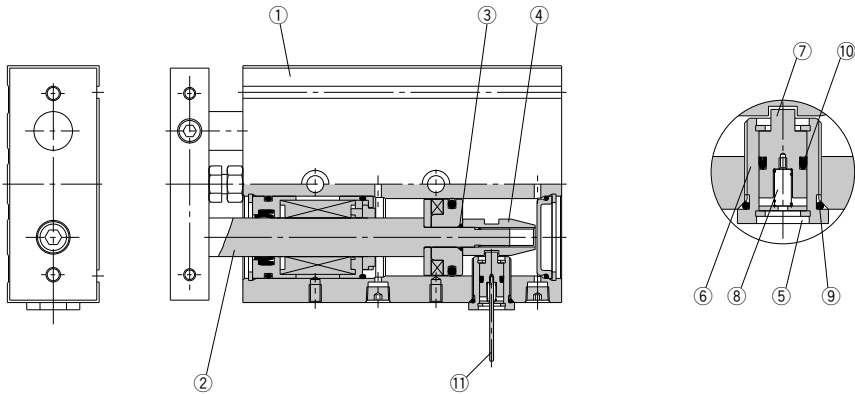

### Component Parts

No.	Description	Material	Note
1	<b>Housing</b>	Aluminum alloy	Hard anodized
2	<b>Piston rod B</b>	Carbon steel	Hard chrome plated
3	<b>O-ring</b>	NBR	
4	<b>Lock rod</b>	Special steel	
5	<b>Retaining ring</b>	Special steel	
6	<b>Lock holder</b>	Aluminum alloy	
7	<b>Lock pin</b>	Special steel	
8	<b>Lock spring</b>	Piano wire	
9	<b>O-ring</b>	NBR	
10	<b>Rod seal</b>	NBR	
11	<b>Manual lever</b>	Special steel	

\* Parts other than those listed above are the same as those for standard type.

### Replacement Parts/Seal Kit

Bore size (mm)	Kit no.	Contents
6	CXSRM6-PS	Includes the kit components of the seal kit featured on page 754 plus items ⑨ and ⑩ from the parts list above.
	CXSRL6APS	
10	CXSRM10-PS	
	CXSRL10APS	
15	CXSRM15-PS	
	CXSRL15APS	
20	CXSRM20-PS	
	CXSRL20APS	
25	CXSRM25-PS	
	CXSRL25APS	
32	CXSRM32-PS	
	CXSRL32APS	

\* Seal kits includes the basic type seal (page 754), ⑨ and ⑩. Order the seal kit, based on each bore size.

\* Since the seal kit does not include a grease pack, order it separately.

**Grease pack part no.:**GR-S-010 (10 g)

Dimensions:  $\phi 6$ ,  $\phi 10$ ,  $\phi 15$

CXS□6-□R

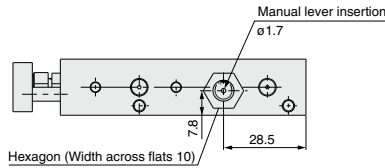
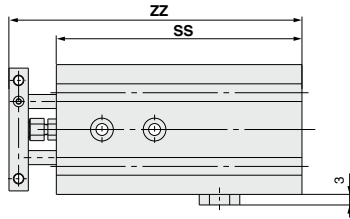

(mm)		
Model	SS	ZZ
CXS□6-10R	75	88.5
CXS□6-20R	85	98.5
CXS□6-30R	95	108.5
CXS□6-40R	105	118.5
CXS□6-50R	115	128.5

\* Dimensions other than those listed above are the same as for the standard type.

CXS□<sup>10</sup>/<sub>15</sub>-□R

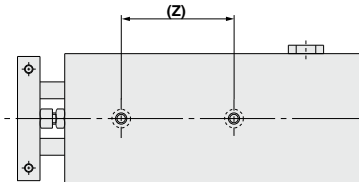
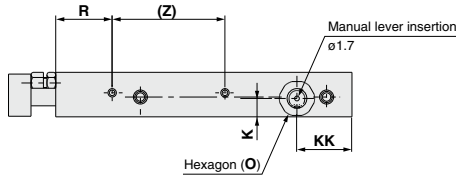
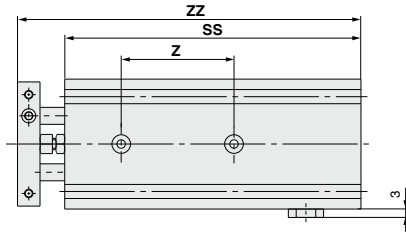

(mm)		
Model	K	O
CXS□10-□R	6.5	Width across flats 12
CXS□15-□R	8.5	Width across flats 13

Model	Symbol Stroke					R					SS					Z					ZZ					
	10	20	30	40	50	10	20	30	40	50	10	20	30	40	50	10	20	30	40	50	10	20	30	40	50	
CXS□10-□R	19.5		24.5			20					80	90	100	115	125	30	40				50	97	107	117	132	142
CXS□15-□R	20.5		20			30					90	100	110	120	130	35				45	109	119	129	139	149	

\* Dimensions other than those listed above are the same as for the standard type.

CX2

CXW

CXT

CXSJ

CXS

D-□

-X□

# CXS Series

Dimensions:  $\varnothing 20$ ,  $\varnothing 25$ ,  $\varnothing 32$

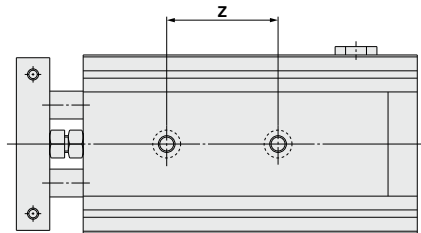
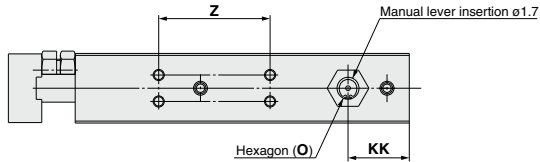
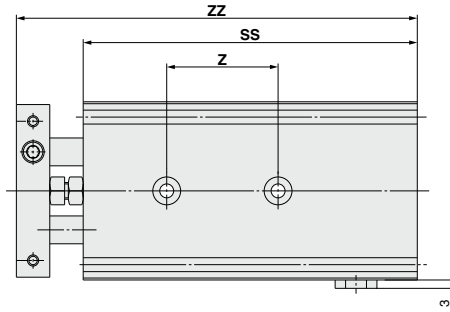

(mm)

Model	O
CXS□20-□R	Width across flats13
CXS□25-□R	Width across flats16
CXS□32-□R	Width across flats19

(mm)

Model	Symbol Stroke	KK						SS						Z						ZZ									
		10	20	30	40	50	75	100	10	20	30	40	50	75	100	10	20	30	40	50	75	100	10	20	30	40	50	75	100
CXS□20-□R				22			27	22	100	110	120	130	140	170	190	40			60			80	124	134	144	154	164	194	214
CXS□25-□R		24.5		29.5			24.5		107	117	132	142	147	172	197	40			60			80	131	141	156	166	171	196	221
CXS□32-□R				29			34	49	122	132	142	152	162	192	232	50			70			90	152	162	172	182	192	222	262

\* Dimensions other than those listed above are the same as for the standard type.

# Auto Switch Mounting

## Auto Switch Proper Mounting Position (Detection at Stroke End)

Electrical entry direction: Inward

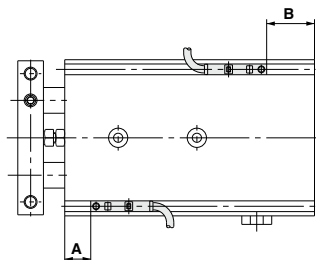

Electrical entry direction: Outward

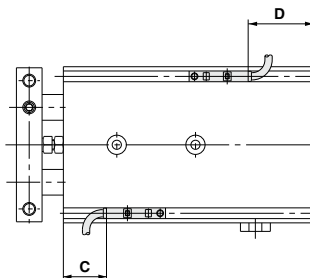

Bore size (mm)	A	B	D-Z7/Z8, D-Y7□W D-Y5□, D-Y7□		D-Y6□, D-Y7□V D-Y7□WV		D-Y7BAL	
			C	D	C	D	C	D
6	15.5	24.5	11.5 (10)	20.5 (19)	13	22	5.5	14.5
10	22.5	22.5	18.5 (17)	18.5 (17)	20	20	12.5	12.5
15	30.5	24.5	26.5 (25)	20.5 (19)	28	22	20.5	14.5
20	38	27	34 (32.5)	23 (21.5)	36	24.5	28	17
25	38	34	34 (32.5)	30 (28.5)	36	31.5	28	24
32	48	39	44 (42.5)	35 (33.5)	46	6.5	38	29

Note) Adjust the auto switch after confirming the operating conditions in the actual setting.

As for auto switch mounting dimensions, auto switch mounting method and its operating range, those are the same as basic type. Refer to page 758.

CX2

CXW

CXT

CXSJ

CXS

D-□

-X□



# CXS Series

## With End Lock for Retraction Side

### Specific Product Precautions

Be sure to read this before handling the products.

Refer to back page 50 for Safety Instructions and pages 3 to 12 for Actuator and Auto Switch Precautions.

#### Recommended Pneumatic Circuit

##### ⚠ Caution

● This is necessary for the proper operation and release of the lock.

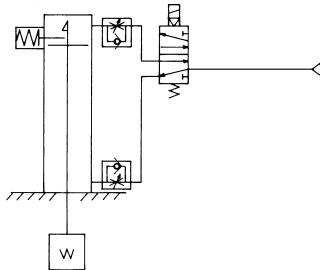

#### Handling Precautions

##### ⚠ Caution

###### 1. Do not use 3 position solenoid valves.

Avoid using in combination with 3 position solenoid valves (especially closed center metal seal types). If pressure is trapped in the port on the head side, the cylinder cannot be locked. Even after being locked, the lock may be released after some time, due to air leakage from the solenoid valve entering the cylinder.

###### 2. Back pressure is required to release the end lock.

Be sure that air is supplied to the rod side before starting operation, as shown in the drawing on the left. The lock may not be released. (Refer to the section on releasing the lock.)

###### 3. Release the lock when mounting and adjusting the cylinder.

An attempt to mount or adjust a cylinder while it is locked can damage the lock.

###### 4. Operate with a load ratio of 50% or less.

If the load ratio exceeds 50%, this may cause problems such as failure of the lock to release, or damage to the lock unit.

###### 5. Do not operate multiple cylinders in synchronization.

Avoid applications in which two or more end lock cylinders are synchronized to move one workpiece, as one of the cylinder locks may not be able to release when required.

###### 6. Install speed controllers as they will be meter-out control.

When they are used under meter-in control, the lock may not be released.

###### 7. Never adjust the retracting stroke using a bumper bolt or external stopper. The lock will not function.

#### Operating Pressure

##### ⚠ Caution

1. Apply a pressure more than 0.3 MPa to the port on the head side. The pressure is necessary to release the lock.

#### Exhaust Speed

##### ⚠ Caution

1. Locking will occur automatically if the pressure applied to the port on the head side falls to 0.05 MPa or less. In cases where the piping on the head side is long and thin, or the speed controller is separated at some distance from the cylinder port, the exhaust speed will be reduced. Note that some time may be required for the lock to engage. In addition, clogging of a silencer mounted on the solenoid valve exhaust port can produce the same effect.

#### Releasing the lock

##### ⚠ Warning

1. Before releasing the lock, be sure to supply air to the rod side, so that there is no load applied to the lock mechanism when it is released. (Refer to the Recommended Pneumatic Circuit.) If the lock is released when the rod side is in an exhaust state, and with a load applied to the lock unit, the lock unit may be subjected to an excessive force and be damaged. Furthermore, sudden movement of the slide table is extremely dangerous.

#### Manual Release

##### Manual release (Non-locking type)

1. Insert the manual lever and screw it into the lock holder assembly. If the lever is screwed in sidelong, it may damage the lock spring.

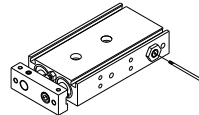

2. To unlock, pull the manual lever in the direction of the arrow. Release the manual lever to return the cylinder to a ready-to-lock state.

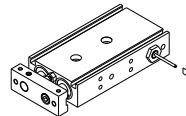

3. The manual lever (ø1.6 x 35 L, tip part: M1.6 x 0.35 x 3 L) is included with the cylinder. If additional manual levers are required, use the following part number to place an order: CXS06-48BK2777 (for all series).

##### ⚠ Caution

Do not use the cylinder while the manual lever is screwed in. It may damage the lock mechanism.

# Dual Rod Cylinder Double Rod Type **CXSW Series** ø6, ø10, ø15, ø20, ø25, ø32

## How to Order

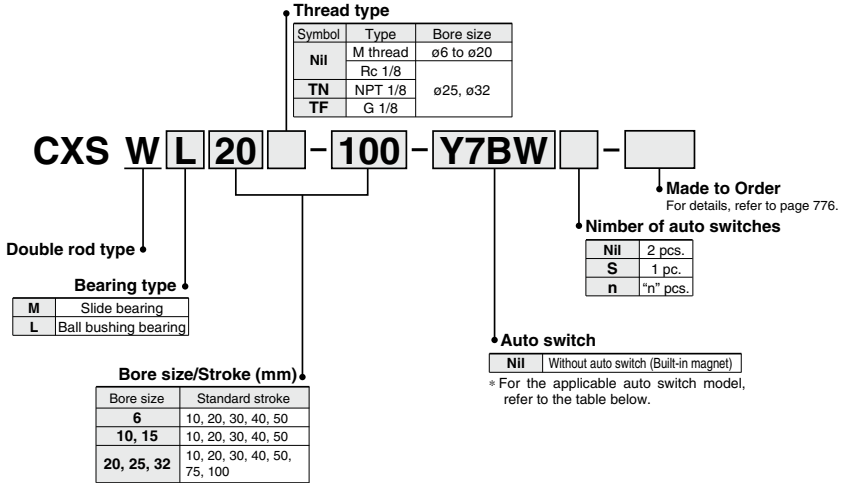

## Applicable Auto Switches

Refer to pages 1119 to 1245 for further information on auto switches.

Type	Special function	Electrical entry	Indicator light	Wiring (Output)	Load voltage		Auto switch model		Lead wire length (m) *			Pre-wired connector	Applicable load			
					DC	AC	Perpendicular	In-line	0.5 (Nil)	3 (L)	5 (Z)		IC circuit	Relay, PLC		
															—	—
Solid state auto switch	—	Grommet	Yes	3-wire (NPN)	5 V, 12 V	—	<b>Y69A</b>	<b>Y59A</b>	●	●	○	○	IC circuit	Relay, PLC		
				3-wire (PNP)			<b>Y7PV</b>	<b>Y7P</b>	●	●	○	○				
				2-wire	<b>Y69B</b>		<b>Y59B</b>	●	●	○	○					
	Diagnostic indication (2-color indicator)			3-wire (NPN)	24 V		5 V, 12 V	<b>Y7NWV</b>	<b>Y7NW</b>	●	●	○	○		○	IC circuit
				3-wire (PNP)			12 V	<b>Y7PWV</b>	<b>Y7PW</b>	●	●	○	○		○	IC circuit
Water resistant (2-color indicator)	—	Grommet	Yes	2-wire	12 V	<b>Y7BWW</b>	<b>Y7BW</b>	●	●	○	○	○	—			
				None	24 V	12 V	—	<b>Y7BA**</b>	—	●	○	○	○	—		
							3-wire (NPN equivalent)	—	5 V	—	<b>Z76</b>	●	●	—	—	IC circuit
Read auto switch	—	Grommet	None	2-wire	24 V	12 V	100 V	<b>Z73</b>	●	●	●	—	—	IC circuit	Relay, PLC	
					100 V or less	<b>Z80</b>	●	●	—	—	—	—	IC circuit			

\*\* Water resistant type auto switches can be mounted on the above models, but in such case SMC cannot guarantee water resistance. Consult with SMC regarding water resistant types with the above model numbers.

\* Lead wire length symbols: 0.5 m ..... Nil (Example) Y59A  
3 m ..... L (Example) Y59AL  
5 m ..... Z (Example) Y59AZ

\* Solid state auto switches marked with "○" are produced upon receipt of order.

- Since there are other applicable auto switches than listed, refer to page 758 for details.
- For details about auto switches with pre-wired connector, refer to pages 1192 and 1193.
- Auto switches are shipped together (not assembled).

**CX2**

**CXW**

**CXT**

**CXSJ**

**CXS**

**D-□**

**-X□**



## Specifications

Bore size (mm)	6	10	15	20	25	32
Fluid	Air (Non-lube)					
Proof pressure	1.05 MPa					
Maximum operating pressure	0.7 MPa					
Minimum operating pressure	0.15 MPa			0.1 MPa		
Ambient and fluid temperature	-10 to 60°C (No freezing)					
Piston speed	50 to 500 mm/s					
Cushion	Bumper is standard on both ends					
Stroke adjustable range	0 to -10 mm compared to the standard stroke (Extended end: 5 mm, Retracted end: 5 mm)					
Port size	M5 x 0.8				Rc 1/8	
Bearing type	Slide bearing, Ball bushing bearing (Same dimensions for both)					

## Standard Stroke

Model	Standard stroke	Long stroke
CXSW□6	10, 20, 30, 40, 50	—
CXSW□10	10, 20, 30, 40, 50	75, 100, 125, 150
CXSW□15		
CXSW□20		
CXSW□25	10, 20, 30, 40, 50, 75, 100	125, 150, 175, 200
CXWS□32		

\* For long strokes, it will be made-to-order. (-XB11)

## Theoretical Output

Model	Rod size (mm)	Piston area (mm <sup>2</sup> )	Operating pressure (MPa)						
			0.1	0.2	0.3	0.4	0.5	0.6	0.7
CXSW□6	4	31	4.6	6.2	9.3	12.4	15.5	18.6	21.7
CXSW□10	6	100	10	20	30	40	50	60	70
CXSW□15	8	252	25.2	50.4	75.6	101	126	151	176
CXSW□20	10	471	47.1	94.2	141	188	236	283	330
CXSW□25	12	756	75.6	151	227	302	378	454	529
CXSW□32	16	1206	121	241	362	482	603	724	844

Note) Theoretical output (N) = Pressure (MPa) x Piston area (mm<sup>2</sup>)

## Weight

Model	Standard stroke (mm)						
	10	20	30	40	50	75	100
CXSWM 6	0.11	0.13	0.14	0.16	0.17	—	—
CXSWL 6	0.12	0.13	0.15	0.16	0.18	—	—
CXSWM 10	0.24	0.26	0.28	0.30	0.32	0.37	0.42
CXSWL 10	0.25	0.27	0.29	0.31	0.33	0.38	0.43
CXSWM 15	0.43	0.45	0.48	0.51	0.54	0.61	0.68
CXSWL 15	0.47	0.50	0.52	0.55	0.58	0.65	0.42
CXSWM 20	0.71	0.74	0.78	0.82	0.85	0.95	1.04
CXSWL 20	0.75	0.79	0.82	0.86	0.90	0.99	1.08
CXSWM 25	1.06	1.11	1.17	1.22	1.28	1.41	1.55
CXSWL 25	1.07	1.12	1.18	1.23	1.29	1.42	1.56
CXSWM 32	2.04	2.12	2.21	2.29	2.38	2.59	2.81
CXSWL 32	2.06	2.15	2.23	2.32	2.41	2.62	2.83



**Made to Order Specifications**  
[Click here for details](#)

Symbol	Specifications
-XB11	Long stroke

### Moisture Control Tube IDK Series



When operating an actuator with a small diameter and a short stroke at a high frequency, the dew condensation (water droplet) may occur inside the piping depending on the conditions.

Simply connecting the moisture control tube to the actuator will prevent dew condensation from occurring. For details, refer to [the IDK series in the Best Pneumatics No. 6](#).



## Operating Conditions

### Maximum Load Mass

When the cylinder is mounted as shown in the diagrams below, the maximum load mass  $W$  should not exceed the values illustrated in the graph immediately following the diagrams.

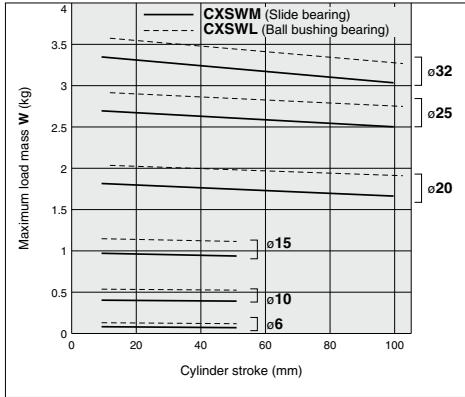
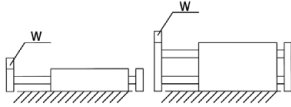

Note) Please consult with SMC regarding the maximum load mass for long strokes depending on your specific usage conditions.

### Allowable Kinetic Energy

Operate a vertically mounted cylinder with a load mass and cylinder speed not exceeding the ranges shown in the graph below. A horizontally mounted cylinder should also be operated with a load weight less than the ranges given in the graph at left. Cylinder speed should be adjusted using a speed controller.

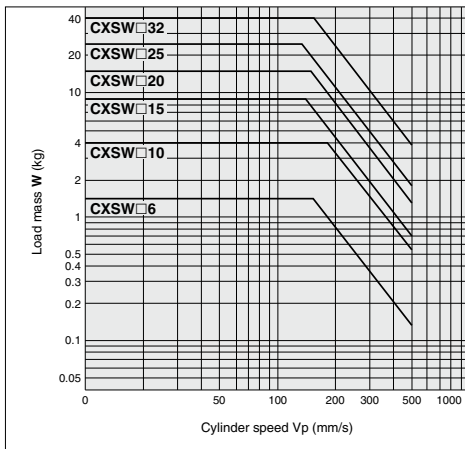

### Deflection at the Plate End

An approximate plate-end deflection  $X$  without a load is shown in the table below.

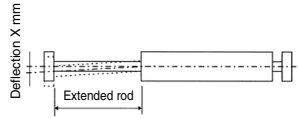

Bore size (mm)	6 to 32
CXSWM (Slide bearing)	±0.03 mm
CXSWL (Ball bushing bearing)	

### Non-rotating accuracy

Non-rotating accuracy  $\theta^\circ$  without a load should be less than or equal to the value provided in the table below as a guide.

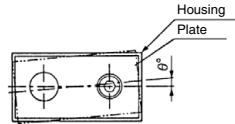

Bore size (mm)	6 to 32
CXSWM (Slide bearing)	±0.1°
CXSWL (Ball bushing bearing)	

**CX2**

**CXW**

**CXT**

**CXSJ**

**CXS**

**D-□**

**-X□**

# CXSW Series

## Construction

### CXSWM (Side bearing)

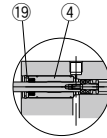
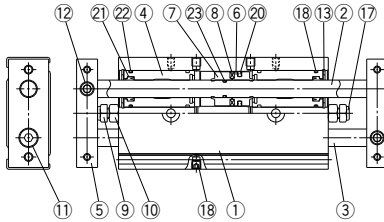

CXSWM6

### CXSWL (Ball bushing bearing)

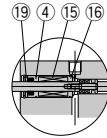
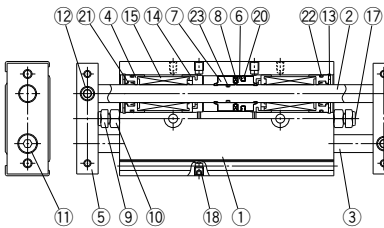

CXSWL6

### (Piston part)

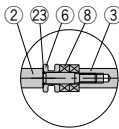

CXSW□6

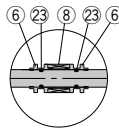

CXSW□10

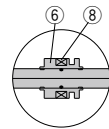

CXSW□25, 32

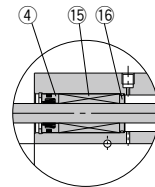

CXSWL10, 15

### Component Parts

No.	Description	Material	Note
1	Housing	Aluminum alloy	Hard anodized
2	Piston rod A	Carbon steel	Hard chrome plated
3	Piston rod B	Carbon steel	Hard chrome plated
4	Rod cover	Aluminum bearing alloy	
5	Plate	Aluminum alloy	Hard anodized
6	Piston A	Aluminum alloy	Chromated
7	Piston B	Aluminum alloy	Chromated
8	Magnet	—	
9	Bumper bolt	Carbon steel	Nickel plated
10	Hexagon nut	Carbon steel	Zinc chromated
11	Hexagon socket head cap screw	Chromium steel	Zinc chromated
12	Hexagon socket head set screw	Chromium steel	Zinc chromated

### Component Parts

No.	Description	Material	Note
13	Retaining ring	Special steel	Phosphate coated
14	Bumper holder	Synthetic resin	
15	Ball bushing	—	
16	Bearing spacer	Synthetic resin	
17	Bumper	Urethane	
18	Plug	Chromium steel	Nickel plated
19	Seal retainer	Aluminum alloy	
20	Piston seal	NBR	
21	Rod seal	NBR	
22	O-ring	NBR	
23	O-ring	NBR	

\* For CXSWL6, aluminum bearing alloy is used for ⑫.

Note) Piston rod for CXSL is quenched.

### Replacement Parts/Seal Kit

Bore size (mm)	Kit no.	Contents
6	CXSWM6-PS	Set of nos. above ⑫, ⑰ and ⑳
	CXSWL6-PS	
10	CXSWM10-PS	
	CXSWL10APS	
15	CXSWM15-PS	
	CXSWL15APS	
20	CXSWM20-PS	
	CXSWL20APS	
25	CXSWM25-PS	
	CXSWL25APS	
32	CXSWM32-PS	
	CXSWL32APS	

\* Seal kit includes ⑳ to ㉓. To order them, use the order number given in the left table.

\* Since the seal kit does not include a grease pack, order it separately.

Grease pack part no.: GR-S-010 (10 g)



# CXSW Series

## Dimensions: $\phi 15$ , $\phi 20$

### CXSW□15

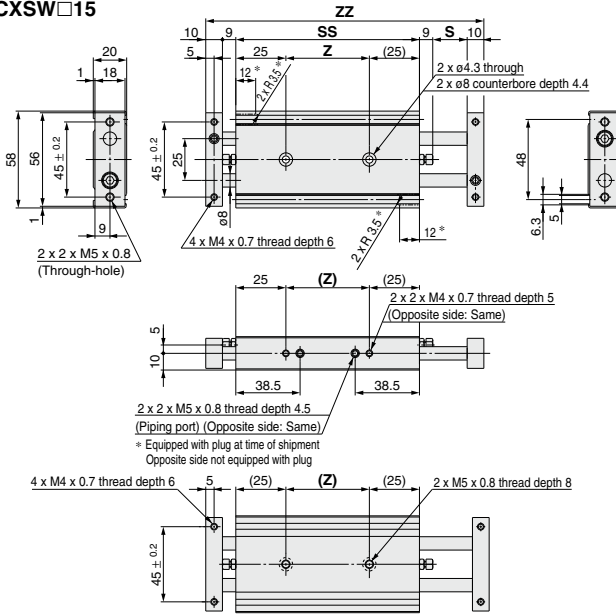

		(mm)				
		Model	S	SS	ZZ	Z
Standard stroke	CXSW□15-10	10	105	153	55	
	CXSW□15-20	20	115	173	65	
	CXSW□15-30	30	125	193	75	
	CXSW□15-40	40	135	213	85	
Long stroke (-XB11)	CXSW□15-50	50	145	233	95	
	CXSW□15-75	75	170	283	120	
	CXSW□15-100	100	195	333	145	
	CXSW□15-125	125	220	383	170	
	CXSW□15-150	150	245	433	195	

\* Only the CXSW□15-10 and the CXSW□15-20 have a groove cut out for installing auto switches. (The dimensions are marked "\*").

### CXSW□20

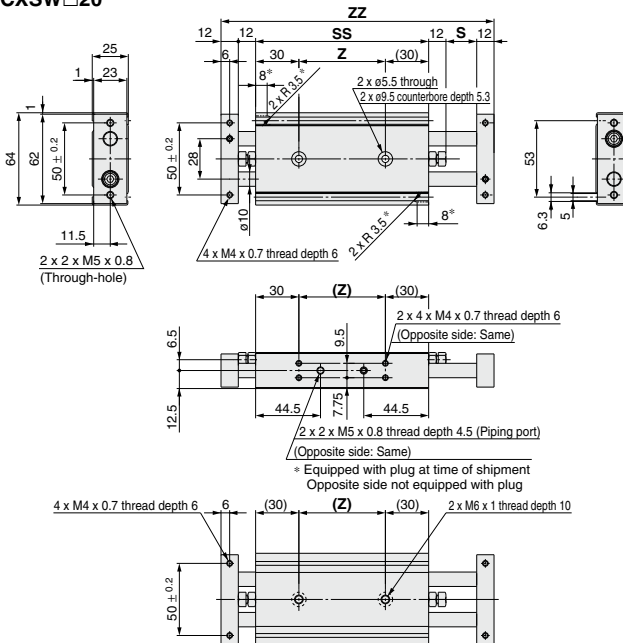

		(mm)				
		Model	S	SS	ZZ	Z
Standard stroke	CXSW□20-10	10	120	178	60	
	CXSW□20-20	20	130	198	70	
	CXSW□20-30	30	140	218	80	
	CXSW□20-40	40	150	238	90	
	CXSW□20-50	50	160	258	100	
Long stroke (-XB11)	CXSW□20-75	75	185	308	125	
	CXSW□20-100	100	210	358	150	
	CXSW□20-125	125	235	408	175	
	CXSW□20-150	150	260	458	200	
	CXSW□20-175	175	285	508	225	
	CXSW□20-200	200	310	558	250	

\* Only the CXSW□20-10 has a groove cut out for installing auto switches. (The dimensions are marked "\*").

**Dimensions:  $\phi 25, \phi 32$**

**CXSW $\square 25$**

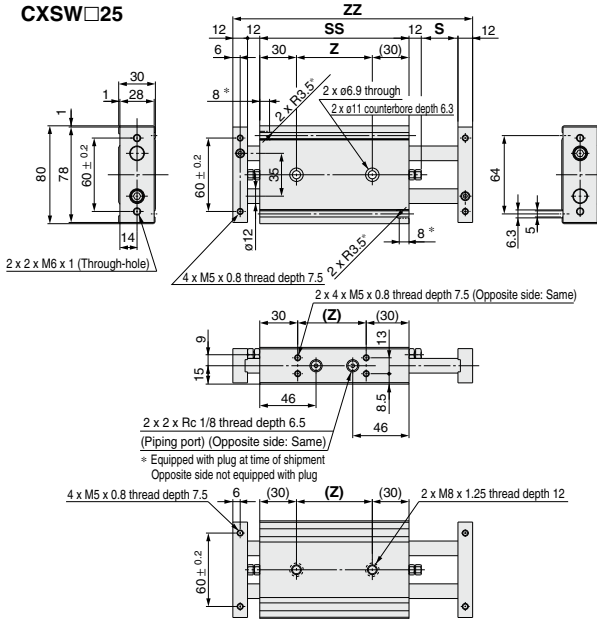

		(mm)				
		Model	S	SS	ZZ	Z
Standard stroke	CXSW $\square 25-10$	10	122	180	62	
	CXSW $\square 25-20$	20	132	200	72	
	CXSW $\square 25-30$	30	142	220	82	
	CXSW $\square 25-40$	40	152	240	92	
	CXSW $\square 25-50$	50	162	260	102	
	CXSW $\square 25-75$	75	187	310	127	
Long stroke (-XB11)	CXSW $\square 25-100$	100	212	360	152	
	CXSW $\square 25-125$	125	237	410	177	
	CXSW $\square 25-150$	150	262	460	202	
	CXSW $\square 25-175$	175	287	510	227	
	CXSW $\square 25-200$	200	312	560	252	

\*Only the CXSW $\square 25-10$  has a groove cut out for installing auto switches.  
(The dimensions are marked "\*".)

**CXSW $\square 32$**

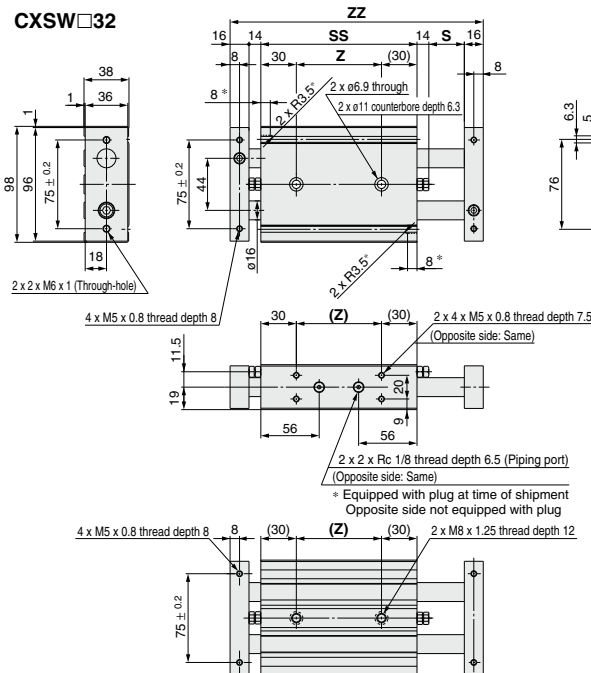

		(mm)				
		Model	S	SS	ZZ	Z
Standard stroke	CXSW $\square 32-10$	10	143	213	83	
	CXSW $\square 32-20$	20	153	233	93	
	CXSW $\square 32-30$	30	163	253	103	
	CXSW $\square 32-40$	40	173	273	113	
	CXSW $\square 32-50$	50	183	293	123	
	CXSW $\square 32-75$	75	208	343	148	
Long stroke (-XB11)	CXSW $\square 32-100$	100	233	393	173	
	CXSW $\square 32-125$	125	258	443	198	
	CXSW $\square 32-150$	150	283	493	223	
	CXSW $\square 32-175$	175	308	543	248	
	CXSW $\square 32-200$	200	333	593	273	

\* Only the CXSW $\square 32-10$  has a groove cut out for installing auto switches.  
(The dimensions are marked "\*".)

**CX2**

**CXW**

**CXT**

**CXSJ**

**CXS**

**D-□**

**-X□**

# CXSW Series Auto Switch Mounting

## Auto Switch Proper Mounting Position (Detection at Stroke End)

Electrical entry direction: Inward

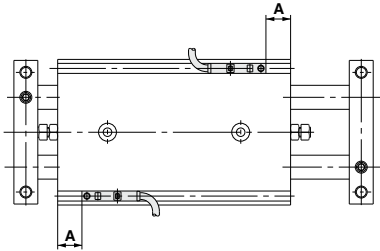

Electrical entry direction: Outward

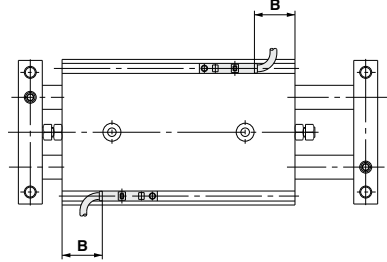

Bore size (mm)	A	D-Z7/Z8, D-Y7□W D-Y5□, D-Y7□	D-Y6□, D-Y7□V D-Y7□WV	D-Y7BA
		B	B	B
6	13.8	9.8(8.3)	11.3	3.8
10	28.5	24.5(23)	26	—
15	35	31(29.5)	32.5	—
20	42.5	38.5(37)	40.5	—
25	43.5	39.5(38)	41.5	33.5
32	54	50(48.5)	52	44

Note) Adjust the auto switch after confirming the operating conditions in the actual setting.

As for auto switch mounting dimensions, auto switch mounting method and its operating range, those are the same as basic type. Refer to page 758