

# Air Cylinder

## CM2 Series

ø20, ø25, ø32, ø40

RoHS

- Female rod end available as standard
- Rod end types suitable for the application can be selected.

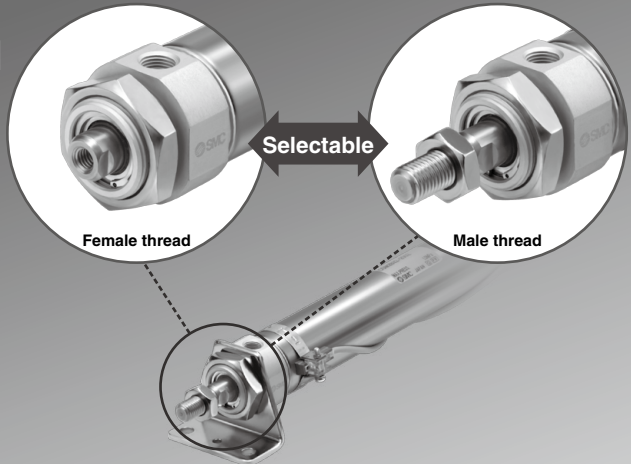

### Easy fine adjustment of auto switch position

Fine adjustment of the auto switch position is possible by simply loosening the screw attached to the auto switch. Transparent switch bracket improves visibility of indicator LED.

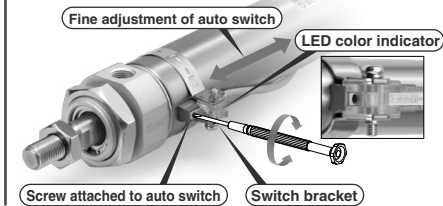

### Single clevis and trunnion pivot brackets are available.

Rotating angle: Max. 202° (Bore size 40 mm)

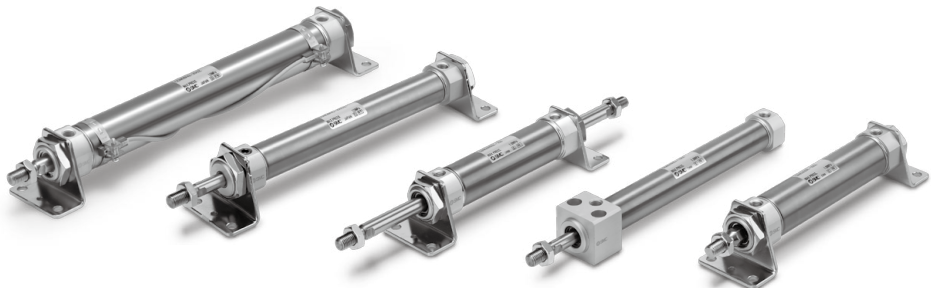
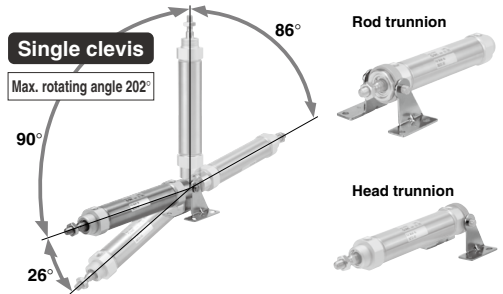

CJ1
CJP
CJ2
JCM
<b>CM2</b>
CM3
CG1
CG3
JMB
MB
MB1
CA2
CS1
CS2

D-□
-X□
Technical Data

## Part numbers with rod end bracket and/or pivot bracket available

Not necessary to order a bracket for the applicable cylinder separately

Note) Mounting bracket is shipped together with the product, but not assembled.

Example) CDM2E20-50Z- **N** **W** -M9BW

Pivot bracket	
Nil	None
<b>N</b>	Pivot bracket is shipped together with the product, but not assembled.

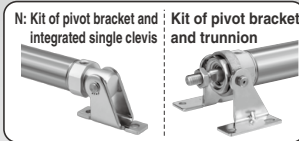

Rod end bracket	
Nil	None
<b>V</b>	Single knuckle joint
<b>W</b>	Double knuckle joint

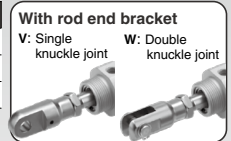

## Various mounting bracket options

- Suitable mounting brackets can be selected for the installation condition.
- Improved amount of mounting freedom

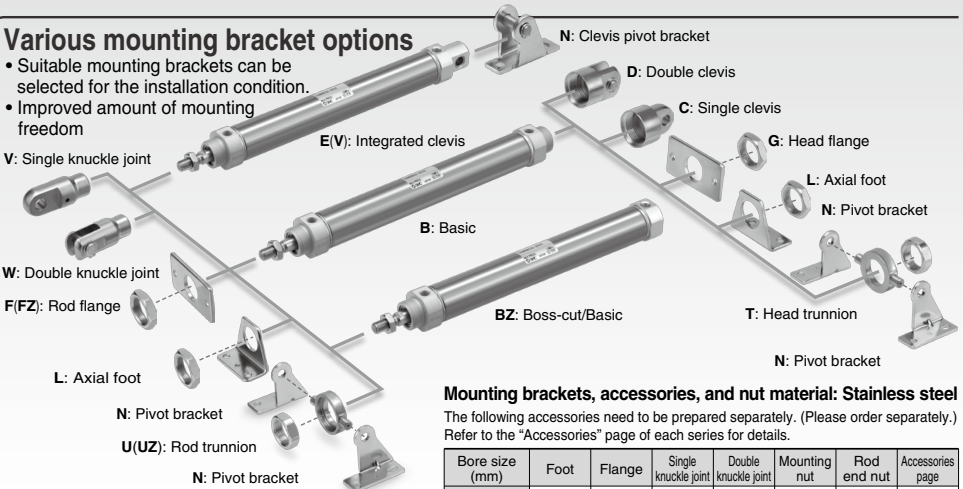

### Mounting brackets, accessories, and nut material: Stainless steel

The following accessories need to be prepared separately. (Please order separately.) Refer to the "Accessories" page of each series for details.

Bore size (mm)	Foot	Flange	Single knuckle joint	Double knuckle joint	Mounting nut	Rod end nut	Accessories page
20, 25, 32, 40	○	○	○	○	○	○	p. 190

## Easy fine adjustment of auto switch position

Fine adjustment of the auto switch set position can be performed by loosening the auto switch attached screw without loosening the auto switch mounting band. Operability improved compared with the current auto switch set position adjustment, where the complete switch mounting band requires loosening.

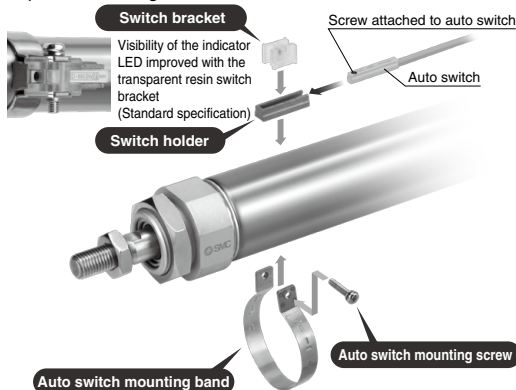

## Total length is shortened with boss-cut type.

Boss for the head cover bracket is eliminated and the total length of cylinder is shortened.



Full Length Dimension Comparison (compared to the basic type (B)) (mm)

ø20	ø25	ø32	ø40
▲13	▲13	▲13	▲16

### Mounting

- Boss-cut/Basic (BZ)
- Boss-cut/Rod flange (FZ)
- Boss-cut/Rod trunnion (UZ)

### No environmental hazardous substances used

Compliant with EU RoHS directive.  
Lead free bushing is used as sliding material.

### Specifications, performance and mounting method are same as the current product.

### Grease is selectable. (Option)

- Grease for food processing equipment (XC85)
- PTFE grease (X446)









### Water resistant compact auto switch mountable

- Solid state auto switch D-M9□A(V)

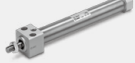
## Stroke Variations

Bore size (mm)	Standard stroke (mm)								
	25	50	75	100	125	150	200	250	300
20	●	●	●	●	●	●	●	●	●
25	●	●	●	●	●	●	●	●	●
32	●	●	●	●	●	●	●	●	●
40	●	●	●	●	●	●	●	●	●

## Series Variations \* For details about the clean series, refer to the "Pneumatic Clean Series" (CAT.E02-23).

Series	Action	Type	Cushion	Bore size (mm)				Variations			Page
				20	25	32	40	With rod boot	Air-hydro	Clean series	
Standard CM2-Z 	Double acting	Single rod	Rubber bumper	●	●	●	●	●	●	●	Page 172
			Air cushion	●	●	●	●	●	●	●	
	Double acting	Double rod	Rubber bumper	●	●	●	●	●	●	●	Page 193
Non-rotating rod CM2K-Z 	Double acting	Single rod	Rubber bumper	●	●	●	●	●	●	●	Page 218
			Air cushion	●	●	●	●	●	●	●	
	Double acting	Double rod	Rubber bumper	●	●	●	●	●	●	●	Page 224
Direct mount CM2R-Z 	Double acting	Single rod	Rubber bumper	●	●	●	●	●	●	●	Page 235
			Air cushion	●	●	●	●	●	●	●	
	Double acting	Single rod (Spring return/extend)	Rubber bumper	●	●	●	●	●	●	●	Page 242
Direct mount, Non-rotating rod CM2RK-Z 	Double acting	Single rod	Rubber bumper	●	●	●	●	●	●	●	Page 246
Centralized piping CM2□P 	Double acting	Single rod	Rubber bumper	●	●	●	●	●	●	●	Page 251
With end lock CBM2 	Double acting	Single rod	Rubber bumper	●	●	●	●	●	●	●	Page 251
			Air cushion	●	●	●	●	●	●	●	
Smooth Cylinder CM2Y-Z 	Double acting	Single rod	Rubber bumper	●	●	●	●	●	●	●	Best Pneumatics No. 2-3
Low Speed Cylinder CM2X-Z 	Double acting	Single rod	Rubber bumper	●	●	●	●	●	●	●	Best Pneumatics No. 2-3
<b>CM3 series</b>											
Short type, Standard CM3 	Double acting	Single rod	Rubber bumper	●	●	●	●	●	●	●	Page 269

- CJ1
- CJP
- CJ2
- JCM
- CM2
- CM3
- CG1
- CG3
- JMB
- MB
- MB1
- CA2
- CS1
- CS2

## Environmentally Resistant Specifications

### Water Resistant

The use of a special scraper allows for improved water resistance.  
Water-resistant cylinder (CM2□R/V)\*1 ..... p. 128

### Corrosion Resistant

External stainless steel cylinder (-XB12)\*1 ..... p. 174  
Fluororubber seal (-XC22)\*1 ..... p. 1804

### Dust Resistant

Durability is 4 times stronger than the standard model.  
Compact cylinder with stable lubrication function (Lube-retainer) (CM2□M)\*1 ..... INFORMATION 12-E597

Prevents dust, etc., adhered to the rod from entering the internal parts  
With heavy duty scraper (-XC4)\*1 ..... p. 1760

### Spatter Resistant

With coil scraper (-XC35)\*1 ..... p. 1823

### Temperature Measures

Heat resistant/Cold resistant cylinder (-XB6, -XB7)\*1 ..... p. 1729, 1731

Refer to "Operating Environment" in the Actuator Precautions.

\*1 The shape (type) is the same as the previous model.

## Applications Requiring Lateral Load Resistance

For use in applications in which a lateral load exceeding the allowable value is to be applied, consider using a guide cylinder.

- D-□
- X□
- Technical Data

# Combinations of Standard Products and Made to Order Specifications

## CM2 Series

- : Standard
- ⊙ : Made to Order
- : Special product (Please contact SMC for details.)
- : Not available

Series	CM2 (Standard type)					CM2K (Non-rotating rod type)				
	Double acting				Single acting	Double acting				Single acting
	Single rod		Double rod		Single rod	Single rod		Double rod		Single rod
	Rubber	Air	Rubber	Air	Rubber	Rubber	Air	Rubber	Air	Rubber
Page	Page 172	Page 193	Page 203	Page 218	Page 224	Page 229				

Symbol	Specifications	Applicable bore size	ø20 to ø40												
<b>Standard</b>	<b>Standard</b>		ø20 to ø40												
D	Built-in magnet	ø20 to ø40	●	●	●	●	●	●	●	●	●	●	●	●	●
CM2□F	With One-touch fittings <small>Note 7)</small>		●	●	●	●	●	○	○	○	○	○	○	○	○
CM2□-□k	With rod boot		●	●	●	●	—	●	●	●	●	—	—	—	—
CM2□H	Air-hydro type		●	—	●	—	—	—	—	—	—	—	—	—	—
10-, 11-	Clean series		●	●	●	○	—	—	—	—	—	—	—	—	—
25A-	Copper (Cu) and Zinc (Zn)-free		●	●	○	○	○	○	○	○	○	○	○	○	○
20- <small>Note 4)</small>	Copper <small>Note 3)</small> and Fluorine-free		●	●	●	●	●	●	●	●	●	●	●	●	●
CM2□R	Water resistant		●	●	○	○	—	—	—	—	—	—	—	—	—
CM2□X	Low speed cylinder		●	—	—	—	—	—	—	—	—	—	—	—	—
CM2□M	Cylinder with stable lubrication function (Lube-retainer)		●	○	○	○	—	—	—	—	—	—	—	—	—
XB6	Heat resistant cylinder (-10 to 150°C) <small>Note 1)</small>	ø20 to ø40	⊙	⊙	⊙	⊙	○	⊙	⊙	⊙	⊙	⊙	○	○	
XB7	Cold resistant cylinder (-40 to 70°C) <small>Note 1)</small>		⊙	○	⊙	○	○	○	○	○	○	○	○	○	○
XB9	Low speed cylinder (10 to 50 mm/s)		⊙	○	○	○	—	○	○	○	○	○	—	—	—
XB12	External stainless steel cylinder <small>Note 7)</small>		⊙	○	⊙	○	⊙	○	○	○	○	○	○	○	○
XC3	Special port location		⊙	⊙	⊙	⊙	⊙	⊙	⊙	⊙	⊙	⊙	⊙	⊙	⊙
XC4	With heavy duty scraper		⊙	⊙	⊙	⊙	○	—	—	—	—	—	○	○	○
XC5	Heat resistant cylinder (-10 to 110°C) <small>Note 1)</small>		⊙	⊙	⊙	⊙	○	○	○	○	○	○	○	○	○
XC6	Made of stainless steel		⊙	⊙	⊙	⊙	⊙	⊙	⊙	⊙	⊙	⊙	⊙	⊙	⊙
XC8	Adjustable stroke cylinder/Adjustable extension type		⊙	⊙	—	—	○	⊙	⊙	—	—	—	○	○	○
XC9	Adjustable stroke cylinder/Adjustable retraction type		⊙	⊙	—	—	○	⊙	○	—	—	—	○	○	○
XC10	Dual stroke cylinder/Double rod type	⊙	⊙	—	—	○	⊙	○	—	—	—	○	○	○	
XC11	Dual stroke cylinder/Single rod type	⊙	⊙	—	—	—	⊙	○	—	—	—	—	—	—	
XC12	Tandem cylinder	ø20 to ø40	⊙	—	—	—	—	○	—	—	—	—	—	—	
XC13	Auto switch rail mounting		⊙	⊙	⊙	⊙	⊙	⊙	⊙	⊙	⊙	⊙	⊙	⊙	
XC20	Head cover axial port		⊙	⊙	—	—	○	⊙	⊙	—	—	—	○	○	
XC22	Fluororubber seal		⊙	⊙	⊙	⊙	⊙	⊙	⊙	⊙	⊙	⊙	⊙	⊙	
XC25	No fixed throttle of connection port		⊙	—	○	—	○	⊙	—	○	—	○	—	○	
XC27	Double clevis and double knuckle joint pins made of stainless steel		⊙	⊙	—	—	○	⊙	⊙	—	—	—	○	○	○
XC29	Double knuckle joint with spring pin		⊙	⊙	⊙	⊙	⊙	○	○	○	○	○	○	○	○
XC35	With coil scraper		⊙	○	⊙	○	—	—	—	—	—	—	—	—	—
XC38	Vacuum specification (Rod through-hole)		—	—	○	○	—	—	—	—	—	—	—	—	—
XC52	Mounting nut with set screw		⊙	⊙	⊙	⊙	⊙	⊙	⊙	⊙	⊙	⊙	⊙	⊙	⊙
XC85	Grease for food processing equipment	⊙	⊙	⊙	⊙	⊙	⊙	⊙	⊙	⊙	⊙	⊙	⊙	⊙	
X446	PTFE grease	⊙	⊙	⊙	⊙	○	⊙	⊙	⊙	⊙	⊙	⊙	⊙	○	

Note 1) The products with an auto switch are not compatible.

Note 2) For details about the smooth cylinder and low speed cylinder, refer to the Best Pneumatics No. 2-3.

Note 3) Copper-free for the externally exposed part. For details, refer to the Web Catalog.

Note 4) For details, refer to the Web Catalog.

Note 5) Available only for locking at head end.

Note 6) Available only for locking at rod end.

Note 7) The shape is the same as the current product.

Note 8) Double end lock is available as a special order.



	CM2R (Direct mount type)		CM2RK (Direct mount, Non-rotating rod type)	CM2□P (Centralized piping) <small>Note 7)</small>	CBM2 (With end lock) <small>Note 7)</small>		CM2Y Smooth Cylinder <small>Note 2)</small>	CM2X Low Speed Cylinder <small>Note 2)</small>	Symbol
	Double acting	Single rod	Double acting	Single rod	Double acting	Air	Single rod	Single rod	
	Rubber	Air	Rubber	Rubber	Rubber	Air	Rubber	Rubber	
	Page 235		Page 242	Page 246	Page 251		Best Pneumatics No. 23	Best Pneumatics No. 23	
ø20 to ø40									
●	●	●	●	●	●	●	●	●	Standard
●	●	●	●	●	●	●	●	●	D
○	○	○	○	○	○	○	●	○	CM2□ F
○	○	○	●	●	—	—	—	—	CM2□-□ <sub>k</sub>
●	—	—	—	—	—	—	—	—	CM2□ H
●	○	—	○	● <small>Note 5)</small>	○	○	○	●	10-, 11-
○	○	○	—	○	○	○	○	—	25A-
●	●	●	○	○	● <small>Note 5)</small>	○	—	—	20- <small>Note 4)</small>
○	○	—	○	○	● <small>Note 5)</small>	—	—	—	CM2□ R
●	—	—	○	—	—	—	—	●	CM2□ X
○	○	—	—	—	—	—	—	—	CM2□ M
◎	◎	◎	—	◎	○	—	—	—	XB6
◎	○	○	—	—	—	—	—	—	XB7
◎	○	○	—	○	○	—	—	—	XB9
○	○	○	—	○	○	—	—	○	XB12
◎	◎	◎	—	◎	○	◎	◎	◎	XC3
○	○	—	◎ <small>Note 5)</small>	○	○	—	—	—	XC4
◎	◎	◎	—	○	○	—	—	—	XC5
◎	◎	◎	◎	◎ <small>Note 5)</small>	○	◎	◎	◎	XC6
◎	○	◎	—	◎ <small>Note 5)</small>	○ <small>Note 5)</small>	○	○	○	XC8
◎	○	◎	—	○ <small>Note 5)</small>	○ <small>Note 5)</small>	◎	◎	◎	XC9
◎	○	○	—	○	○	◎	◎	◎	XC10
◎	◎	◎	—	○	○	—	—	—	XC11
○	—	○	—	—	—	—	—	—	XC12
◎	◎	◎	○	◎	○	◎	◎	◎	XC13
◎	◎	◎	—	○ <small>Note 5)</small>	—	◎	◎	◎	XC20
◎	◎	◎	—	◎	◎	—	—	—	XC22
◎	—	◎	—	○	—	◎	◎	◎	XC25
—	—	—	○	◎	◎	◎	◎	◎	XC27
◎	◎	○	◎	◎	◎	◎	◎	◎	XC29
○	○	—	○	◎ <small>Note 5)</small>	○	—	—	—	XC35
—	—	—	—	—	—	○	○	○	XC38
—	—	—	◎	◎	◎	◎	◎	◎	XC52
◎	◎	◎	◎	○	○	—	—	—	XC85
◎	◎	◎	—	—	—	—	—	—	X446

- CG1
- CJP
- CJ2
- JCM
- CM2
- CM3
- CG1
- CG3
- JMB
- MB
- MB1
- CA2
- CS1
- CS2

- D-□
- X□
- Technical Data

# Air Cylinder: Standard Type Double Acting, Single Rod

## CM2 Series

ø20, ø25, ø32, ø40

RoHS



### How to Order

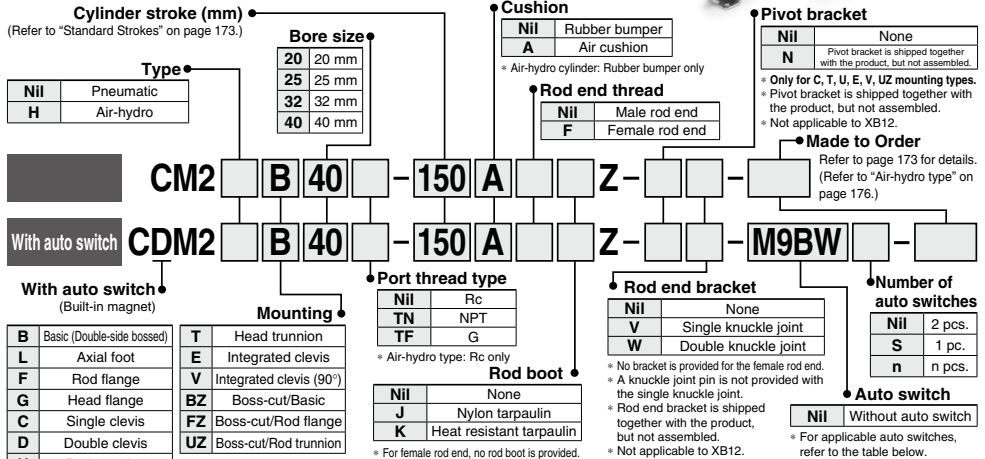

\* Refer to "Ordering Example of Cylinder Assembly" on page 173.

### Applicable Auto Switches/Refer to pages 1575 to 1701 for further information on auto switches.

Type	Special function	Electrical entry	Indicator light	Wiring (Output)	Load voltage		Auto switch model		Lead wire length (m)					Pre-wired connector	Applicable load			
					DC	AC	Perpendicular	In-line	0.5 (Nil)	1 (M)	3 (L)	5 (Z)	None (N)					
																Yes	No	Yes
Solid state auto switch	—	Grommet	Yes	3-wire (NPN)	5 V, 12 V	—	M9NV	M9N	●	●	○	—	—	IC circuit	Relay, PLC			
				3-wire (PNP)			M9PV	M9P	●	●	○	—						
		Connector		2-wire	12 V	M9BV	M9B	●	●	●	●	—	—					
				3-wire (NPN)	5 V, 12 V	—	H7C	●	—	●	●	—						
		Terminal conduit		2-wire	12 V	—	G39A	●	—	—	—	—	IC circuit					
	3-wire (PNP)		5 V, 12 V	—	K39A	—	—	—	●	—								
	Diagnostic indication (2-color indicator)	Grommet	Yes	3-wire (NPN)	5 V, 12 V	—	M9NVV	M9NV	●	●	○	—	—	IC circuit				
				3-wire (PNP)			M9PVV	M9PV	●	●	○	—						
				2-wire	12 V	M9BWW	M9BW	●	●	○	—	—						
				3-wire (NPN)	5 V, 12 V	M9NAV*1	M9NA*1	○	○	○	—		IC circuit					
3-wire (PNP)				5 V, 12 V	M9PAV*1	M9PA*1	○	○	○	—								
Water resistant (2-color indicator)	Grommet	Yes	2-wire	12 V	—	M9BAV*1	M9BA*1	○	○	○	—	—	—					
			4-wire (NPN)			5 V, 12 V	—	H7NF	●	—	○	—						
			—	Grommet	Yes	3-wire (NPN equivalent)	5 V	—	A96V	A96	●	—		—	—	IC circuit		
									100 V	A93V*2	A93	●		●	●		—	—
									100 V or less	A90V	A90	●		—	—		—	
—	Connector	No	2-wire	24 V	12 V	—	—	B54	●	—	●	—	—					
							100 V, 200 V	—	B64	●	—	—		—				
							200 V or less	—	C73C	●	—	●		—				
							24 V or less	—	C80C	●	—	●		—				
							—	—	A33A	—	—	—		—	—			
Diagnostic indication (2-color indicator)	Grommet	Yes	—	—	—	—	—	A34A	—	—	—	●	—					
							—	A44A	—	—	—	●						
							—	B59W	●	—	—	—						

\*1 Water resistant type auto switches can be mounted on the above models, but in such case SMC cannot guarantee water resistance.

A water-resistant type cylinder is recommended for use in an environment which requires water resistance.

\*2 1 m type lead wire is only applicable to D-A93.

\* Lead wire length symbols: 0.5 m ..... Nil (Example) M9NW  
1 m ..... M (Example) M9NWW  
3 m ..... L (Example) M9NWL  
5 m ..... Z (Example) M9NWZ  
None ..... N (Example) H7CN

\* Solid state auto switches marked with "○" are produced upon receipt of order.

\* Do not indicate suffix "N" for no lead wire on the D-A93/A/A44A/G39A/K39A models.

\* Since there are other applicable auto switches than listed above, refer to page 266 for details.

\* For details about auto switches with pre-wired connector, refer to pages 1648 and 1649.

\* The D-A9□□/M9□□□ auto switches are shipped together, (but not assembled). (However, only the auto switch mounting brackets are assembled before shipment.)

## Specifications



### Symbol

Double acting, Single rod

Air cushion

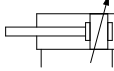
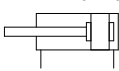

Refer to pages 262 to 266 for cylinders with auto switches

- Auto switch proper mounting position (detection at stroke end) and its mounting height
- Minimum stroke for auto switch mounting
- Operating range
- Auto switch mounting brackets/Part no.



**Made to Order: Individual Specifications**  
(For details, refer to page 267.)

Symbol	Specifications
-X446	PTFE grease

### Made to Order

[Click here for details](#)

Symbol	Specifications
-XA□	Change of rod end shape
-XB6	Heat resistant cylinder (-10 to 150°C)
-XB7	Cold resistant cylinder (-40 to 70°C) <sup>*1</sup>
-XB9	Low speed cylinder (10 to 50 mm/s) <sup>*1</sup>
-XB12	External stainless steel cylinder <sup>*2</sup>
-XC3	Special port location
-XC4	With heavy duty scraper
-XC5	Heat resistant cylinder (-10 to 110°C)
-XC6	Made of stainless steel
-XC8	Adjustable stroke cylinder/Adjustable extension type
-XC9	Adjustable stroke cylinder/Adjustable retraction type
-XC10	Dual stroke cylinder/Double rod type <sup>*1</sup>
-XC11	Dual stroke cylinder/Single rod type
-XC12	Tandem cylinder <sup>*1</sup>
-XC13	Auto switch rail mounting
-XC20	Head cover axial port
-XC22	Fluororubber seal
-XC25	No fixed throttle of connection port <sup>*1</sup>
-XC27	Double clevis and double knuckle pins made of stainless steel
-XC29	Double knuckle joint with spring pin
-XC35	With coil scraper <sup>*1</sup>
-XC52	Mounting nut with set screw
-XC85	Grease for food processing equipment

<sup>\*1</sup> Rubber bumper only.

<sup>\*2</sup> The shape is the same as the current product.

Bore size (mm)		20	25	32	40
Type		Pneumatic			
Action		Double acting, Single rod			
Fluid		Air			
Proof pressure		1.5 MPa			
Maximum operating pressure		1.0 MPa			
Minimum operating pressure		0.05 MPa			
Ambient and fluid temperature		Without auto switch: -10°C to 70°C (No freezing) With auto switch: -10°C to 60°C			
Lubrication		Not required (Non-lube)			
Stroke length tolerance		$^{+1.4}_0$ mm			
Piston speed		Rubber bumper: 50 to 750 mm/s, Air cushion: 50 to 1000 mm/s			
Cushion		Rubber bumper, Air cushion			
Allowable kinetic energy	Rubber bumper	0.27 J	0.4 J	0.65 J	1.2 J
	Male thread	0.11 J	0.18 J	0.29 J	0.52 J
	Female thread	0.54 J (11.0)	0.78 J (11.0)	1.27 J (11.0)	2.35 J (11.8)
	Air cushion (Effective cushion length (mm))	0.11 J	0.18 J	0.29 J	0.52 J

\* Operate the cylinder with in the allowable kinetic energy.

## Standard Strokes

Bore size (mm)	Standard stroke (mm) <sup>Note 1)</sup>	Maximum manufacturable stroke (mm)
20	25, 50, 75, 100, 125, 150, 200, 250, 300	1000
25		1500
32		2000
40		

Note 1) Intermediate strokes not listed above are produced upon receipt of order.

Manufacture of intermediate strokes in 1 mm increments is possible. (Spacers are not used.)

Note 2) Applicable strokes should be confirmed according to the usage. For details, refer to "Air Cylinders Model Selection" on front matter pages. In addition, the products that exceed the standard stroke might not be able to fulfill the specifications due to the deflection etc.

## Rod Boot Material

Symbol	Rod boot material	Maximum ambient temperature
J	Nylon tarpaulin	70°C
K	Heat resistant tarpaulin	110°C <sup>*1</sup>

<sup>\*1</sup> Maximum ambient temperature for the rod boot itself.

## Option: Ordering Example of Cylinder Assembly

**Cylinder model: CDM2C20-50Z-NV-M9BW**

**Mounting C: Single clevis**  
**Pivot bracket N: Yes**  
**Rod end bracket V: Single knuckle joint**  
**Auto switch D-M9BW: 2 pcs.**

<sup>\*</sup> Pivot bracket, single knuckle joint and auto switch are shipped together with the product, but not assembled.

<sup>\*</sup> Pivot bracket is available only for C, T, U, E, V, UZ mounting types.

<sup>\*</sup> No bracket is provided for the female rod end.

## Mounting and Accessories

Accessories	Standard (mounted to the body)							Standard (packaged together, but not assembled)							Option			
	Body	Mounting nut Note 1)	Rod end nut (Male thread)	Single clevis	Double clevis Note 7)	Liner	Mounting nut	Foot	Flange	Pivot bracket	Pivot bracket pin Note 5)	Double clevis pin Note 5)	Trunnion	Mounting nut (For trunnion)	Clevis pivot bracket (CM2E/CM2V)	Clevis pivot bracket pin (CM2E/CM2V)	Single knuckle joint (Male thread only)	Double knuckle joint (Male thread only)
<b>B</b> Basic (Double-side bossed)	●(1 pc.)	●(1 pc.)	●(1 pc.)	—	—	—	—	—	—	—	—	—	—	—	—	—	●	●
<b>L</b> Axial foot	●(1 pc.)	●(1 pc.) <sup>Note 3)</sup>	●(1 pc.)	—	—	—	●(1 pc.)	●(2 pcs.)	—	—	—	—	—	—	—	—	●	●
<b>F</b> Rod flange	●(1 pc.)	●(1 pc.)	●(1 pc.)	—	—	—	—	—	—	—	—	—	—	—	—	—	●	●
<b>G</b> Head flange	●(1 pc.)	●(1 pc.)	●(1 pc.)	—	—	—	—	—	—	—	—	—	—	—	—	—	●	●
<b>C</b> Single clevis	●(1 pc.)	— <sup>Note 3)</sup>	●(1 pc.)	●(1 pc.)	—	—	—	—	—	—	—	—	—	—	—	—	●	●
<b>D</b> Double clevis	●(1 pc.)	— <sup>Note 3)</sup>	●(1 pc.)	—	●(1 pc.)	—	—	—	—	—	—	—	—	—	—	—	●	●
<b>U</b> Rod trunnion	●(1 pc.)	— <sup>Note 4)</sup>	●(1 pc.)	—	—	—	—	—	—	—	—	—	—	—	—	—	●	●
<b>T</b> Head trunnion	●(1 pc.)	— <sup>Note 4)</sup>	●(1 pc.)	—	—	—	—	—	—	—	—	—	—	—	—	—	●	●
<b>E</b> Integrated clevis	●(1 pc.)	— <sup>Note 3)</sup>	●(1 pc.)	—	—	—	—	—	—	—	—	—	—	—	—	—	●	●
<b>V</b> Integrated clevis (90°)	●(1 pc.)	— <sup>Note 3)</sup>	●(1 pc.)	—	—	—	—	—	—	—	—	—	—	—	—	—	●	●
<b>BZ</b> Boss-cut/Basic	●(1 pc.)	●(1 pc.)	●(1 pc.)	—	—	—	—	—	—	—	—	—	—	—	—	—	●	●
<b>FZ</b> Boss-cut/ Rod flange	●(1 pc.)	●(1 pc.)	●(1 pc.)	—	—	—	—	—	—	—	—	—	—	—	—	—	●	●
<b>UZ</b> Boss-cut/ Rod trunnion	●(1 pc.)	— <sup>Note 4)</sup>	●(1 pc.)	—	—	—	—	—	—	—	—	—	—	—	—	—	●	●

	Standard (mounted to the body)							Option											
Mounting: <b>C</b> Pivot bracket symbol: <b>N</b> Single clevis + Pivot bracket + Pin	●(1 pc.)	— <sup>Note 3)</sup>	●(1 pc.)	●(1 pc.)	—	—	—	●(Max. 3 pcs.)	— <sup>Note 3)</sup>	—	—	—	—	—	—	—	—	●	●
Mounting: <b>T, U, UZ</b> Pivot bracket symbol: <b>N</b> Trunnion + Pivot bracket	●(1 pc.)	— <sup>Note 4)</sup>	●(1 pc.)	—	—	—	—	—	—	—	—	—	—	—	—	—	—	●	●
Mounting: <b>E</b> Pivot bracket symbol: <b>N</b> Integrated clevis + Pivot bracket + Pin	●(1 pc.)	— <sup>Note 3)</sup>	●(1 pc.)	—	—	—	—	—	—	—	—	—	—	—	—	—	—	●(1 pc.)	●(1 pc.)
Mounting: <b>V</b> Pivot bracket symbol: <b>N</b> Integrated clevis (90°) + Pivot bracket + Pin	●(1 pc.)	— <sup>Note 3)</sup>	●(1 pc.)	—	—	—	—	—	—	—	—	—	—	—	—	—	—	●(1 pc.)	●(1 pc.)

Note 1) Rod end nut is not provided for the female rod end.  
 Note 2) Two mounting nuts are packaged together.  
 Note 3) Mounting nut is not packaged for the clevis.  
 Note 4) Trunnion nut is packaged for U, T, UZ.  
 Note 5) Retaining rings are included.

Note 6) A pin and retaining rings (split pins for ø40) are included.  
 Note 7) This is the part(s) used to adjust the clevis angle. Mounting quantity can vary.  
 \* Stainless steel mounting brackets and accessories are also available.  
 Refer to page 190 for details.

## Mounting Brackets/Part No.

Mounting bracket	Min. order q'ty	Bore size (mm)				Contents (for minimum order quantity)
		20	25	32	40	
Foot*	2	CM-L020B	CM-L032B	CM-L040B	2 feet, 1 mounting nut	
Flange	1	CM-F020B	CM-F032B	CM-F040B	1 flange	
Single clevis**	1	CM-C020B	CM-C032B	CM-C040B	1 single clevis, 3 liners	
Double clevis (with pin)**	1	CM-D020B	CM-D032B	CM-D040B	1 double clevis, 3 liners, 1 clevis pin, 2 retaining rings	
Double clevis pin	1	CDP-1			1 clevis pin, 2 retaining rings (split pins)	
Trunnion (with nut)	1	CM-T020B	CM-T032B	CM-T040B	1 trunnion, 1 retaining rings	
Rod end nut	1	NT-02	NT-03	NT-04	1 rod end nut	
Mounting nut	1	SN-020B	SN-032B	SN-040B	1 mounting nut	
Trunnion nut	1	TN-020B	TN-032B	TN-040B	1 trunnion nut	
Single knuckle joint	1	I-020B	I-032B	I-040B	1 single knuckle joint	
Double knuckle joint	1	Y-020B	Y-032B	Y-040B	1 double knuckle joint, 1 knuckle pin, 2 retaining rings	
Double knuckle joint pin	1	CDP-1			1 knuckle pin, 2 retaining rings (split pins)	
Clevis pivot bracket pin (For CM2E/CM2V)	1	CD-S02		CD-S03	1 clevis pin, 2 retaining rings	
Clevis pivot bracket (For CM2E/CM2V)	1	CM-E020B		CM-E032B	1 clevis pivot bracket, 1 clevis pin, 2 retaining rings	
Pivot bracket (For CM2C)	1	CM-B032			2 pivot brackets (1 of each type)	
Pivot bracket pin (For CM2C)	1	CDP-1			1 pin, 2 retaining rings	
Pivot bracket (For CM2T/CM2U)	1	CM-B020	CM-B032	CM-B040	2 pivot brackets (1 of each type)	

\* Order 2 feet per cylinder.  
 \*\* 3 liners are included with a clevis bracket for adjusting the mounting angle.  
 \*\*\* A clevis pin and retaining rings (split pins for ø40) are included.

For dimensions of accessories (options), refer to pages 189 and 190.

**Mounting Brackets, Accessories/Material, Surface Treatment**

Segment	Description	Material	Surface treatment
Mounting brackets	Foot	Carbon steel	Nickel plating
	Flange	Carbon steel	Nickel plating
	Single clevis	Carbon steel	Nickel plating
	Double clevis	Carbon steel	Nickel plating
	Trunnion	Cast iron	Electroless nickel plating
Accessories	Rod end nut	Carbon steel	Zinc chromated
	Mounting nut	Carbon steel	Nickel plating
	Trunnion nut	Carbon steel	Nickel plating
	Clevis pivot bracket	Carbon steel	Nickel plating
	Clevis pivot bracket pin	Carbon steel	(None)
	Single knuckle joint	Carbon steel ø40: Free-cutting steel	Electroless nickel plating
	Double knuckle joint	Carbon steel ø40: Cast iron	Electroless nickel plating Metallic silver color painting for ø40
	Double clevis pin	Carbon steel	(None)
	Double knuckle joint pin	Carbon steel	(None)
	Pivot bracket	Carbon steel	Nickel plating
	Pivot bracket pin	Carbon steel	(None)

**Weights**

		(kg)			
		20	25	32	40
Basic weight	Bore size (mm)				
	Basic (Double-side bossed)	0.14	0.21	0.28	0.56
	Axial foot	0.29	0.37	0.44	0.83
	Flange	0.20	0.30	0.37	0.68
	Integrated clevis	0.12	0.19	0.27	0.52
	Single clevis	0.18	0.25	0.32	0.65
	Double clevis	0.19	0.27	0.33	0.69
	Trunnion	0.18	0.28	0.34	0.66
	Boss-cut/Basic	0.13	0.19	0.26	0.53
	Boss-cut/Flange	0.19	0.28	0.35	0.65
Boss-cut/Trunnion	0.17	0.26	0.32	0.63	
Additional weight per 50 mm of stroke		0.04	0.06	0.08	0.13
Weight reduction for female rod end		-0.01	-0.02	-0.02	-0.04
Option bracket	Clevis pivot bracket (with pin)	0.07	0.07	0.14	0.14
	Single knuckle joint	0.06	0.06	0.06	0.23
	Double knuckle joint (with pin)	0.07	0.07	0.07	0.20
	Pivot bracket	0.06	0.06	0.06	0.06
	Pivot bracket pin	0.02	0.02	0.02	0.03

Calculation: (Example) **CM2L32-100Z**  
 ● Basic weight.....0.44 (Foot, ø32)  
 ● Additional weight.....0.08/50 stroke  
 ● Cylinder stroke.....100 stroke  
 $0.44 + 0.08 \times 100/50 = 0.60 \text{ kg}$

**⚠ Precautions**

Be sure to read this before handling the products. Refer to back page 50 for Safety Instructions and pages 3 to 12 for Actuator and Auto Switch Precautions.

**Handling**

**⚠ Warning**

- Do not rotate the cover.**  
If a cover is rotated when installing a cylinder or screwing a fitting into the port, it is likely to damage the junction part with cover.
- Operate the cylinder within the specified cylinder speed, kinetic energy and lateral load at the rod end.**
- The allowable kinetic energy is different between the cylinders with male rod end and with female rod end due to the different thread sizes.**
- When female rod end is used, use a washer, etc. to prevent the contact part at the rod end from being deformed depending on the material of the workpiece.**
- Do not apply excessive lateral load to the piston rod.**  
Easy checking method  
Minimum operating pressure after the cylinder is mounted to the equipment (MPa) = Minimum operating pressure of cylinder (MPa) + (Load mass (kg) x Friction coefficient of guide/Sectional area of cylinder (mm<sup>2</sup>))  
If smooth operation is confirmed within the above value, the load on the cylinder is the resistance of the thrust only and it can be judged as having no lateral load.
- Do not operate with the cushion needle in a fully closed condition.**  
Using it in the fully closed state will cause the cushion seal to be damaged. When adjusting the cushion needle, use the "Hexagon wrench key: nominal size 1.5".
- Do not open the cushion needle wide excessively.**  
If the cushion needle were set to be completely wide (more than 3 turns from fully closed), it would be equivalent to the cylinder with no cushion, thus making the impacts extremely high. Do not use it in such a way. Besides, using with fully open could give damage to the piston or cover.
- Do not open the cushion needle after rotating it numerous times in a row. Though uncommon, there are cases in which the cushion needle may leak air.**  
The cushion needle should be adjusted by gradually opening it while checking the operation of the cylinder cushion. In the unlikely event that air leakage occurs, return the cushion needle to the fully-closed state, and readjust the cushion needle to the desired position.

**⚠ Caution**

- Not able to disassemble.**  
Cover and cylinder tube are connected to each other by caulking method, thus making it impossible to disassemble. Therefore, internal parts of a cylinder other than rod seal are not replaceable.
- Use caution to the popping of a retaining ring.**  
When replacing rod seals and removing and mounting a retaining ring, use a proper tool (retaining ring plier: tool for installing a type C retaining ring). Even if a proper tool is used, it is likely to inflict damage to a human body or peripheral equipment, as a retaining ring may be flown out of the tip of a plier. Be much careful with the popping of a retaining ring. Besides, be certain that a retaining ring is placed firmly into the groove of rod cover before supplying air at the time of installation.
- Do not touch the cylinder during operation.**  
Use caution when handling a cylinder, which is running at a high speed and a high frequency, because the surface of a cylinder tube could get so hot enough as to cause you get burned.
- Do not use the air cylinder as an air-hydro cylinder.**  
If it uses turbine oil in place of fluids for cylinder, it may result in oil leak.
- The oil stuck to the cylinder is grease.**
- The base oil of grease may seep out.**  
The base oil of grease in the cylinder may seep out of the tube, cover, crimped part or rod bushing depending on the operating conditions (ambient temperature 40°C or more, pressurized condition, low frequency operation).
- When rod end female thread is used, use a thin wrench when tightening the piston rod.**
- Combine the rod end section, so that a rod boot might not be twisted.**  
If a rod boot is installed with being twisted when installing a cylinder, it will cause a rod boot to fail during operation.
- When using a rod end bracket and/or pivot bracket, make sure they do not interfere with other brackets, workpieces and rod section, etc.**

CJ1  
CJP  
CJ2  
JCM  
CM2  
CM3  
CG1  
CG3  
JMB  
MB  
MB1  
CA2  
CS1  
CS2

D-□  
-X□  
Technical Data

# CM2 Series

## Built-in One-touch Fittings (The shape is the same as the current product.)

CM2   F —   
 ↓  
 Built-in One-touch fittings

This type has the One-touch fitting integrated in a cylinder, which enables to reduce the piping labor and installing space dramatically.



### Specifications

<b>Action</b>	Double acting, Single rod
<b>Bore size (mm)</b>	ø20, ø25, ø32, ø40
<b>Max. operating pressure</b>	1.0 MPa
<b>Min. operating pressure</b>	0.05 MPa
<b>Cushion</b>	Rubber bumper
<b>Piping</b>	One-touch fittings
<b>Piston speed</b>	50 to 750 mm/s
<b>Mounting</b>	Basic, Axial foot, Rod flange, Head flange, Single clevis, Double clevis, Rod trunnion, Head trunnion, Integrated clevis, Boss-cut

\* Auto switch can be mounted.

### Applicable Tubing O.D./I.D.

Bore size (mm)	20	25	32	40
Applicable tubing O.D./I.D. (mm)	6/4	6/4	6/4	8/6
Applicable tubing material	Can be used for either nylon, soft nylon or polyurethane tubing.			

### ⚠ Caution

- One-touch fitting cannot be replaced.
  - One-touch fitting is press-fit into the cover, thus cannot be replaced.
- Refer to Fittings and Tubing Precautions (Best Pneumatics No. 7) for handling One-touch fittings.

## Air-hydro

CM2H   —   Z —   
 ↓  
 Air-hydro

A low hydraulic pressure cylinder used at a pressures of 1.0 MPa or below.

Through the concurrent use of the CC series air-hydro unit, it is possible to operate at a constant or low speeds or to effect an intermediate stop, just like a hydraulic unit, while using pneumatic equipment such as a valve.



- For construction, refer to page 179.
- Since the dimensions of mounting type are the same as pages 181 to 188, refer to those pages.

### Specifications

<b>Type</b>	Air-hydro	
<b>Fluid</b>	Turbine oil	
<b>Action</b>	Double acting, Single rod	
<b>Bore size (mm)</b>	ø20, ø25, ø32, ø40	
<b>Proof pressure</b>	1.5 MPa	
<b>Max. operating pressure</b>	1.0 MPa	
<b>Min. operating pressure</b>	0.18 MPa	
<b>Piston speed</b>	15 to 300 mm/s	
<b>Ambient and fluid temperature</b>	+5 to +60°C	
<b>Stroke length tolerance</b>	+1.4 0 mm	
<b>Cushion</b>	Rubber bumper (Standard equipment)	
<b>Mounting</b>	Basic, Axial foot, Rod flange, Head flange, Single clevis, Double clevis, Rod trunnion, Head trunnion, Integrated clevis, Integrated clevis (90°), Boss-cut	
<b>Made to Order**</b>	-XA <input type="checkbox"/>	Change of rod end shape
	-XC3 <input type="checkbox"/>	Special port location

\* Auto switch can be mounted. Dimensions are the same as the standard type.

\*\* For details, refer to pages 1703 to 1896.



## Clean Series

10-CM2 Mounting type Bore size - Stroke **Z**

• Clean Series (With relief port)

The type which is applicable for using inside the clean room graded ISO Class 4 by making an actuator's rod section a double seal construction and discharging by relief port directly to the outside of clean room.



### Specifications

<b>Action</b>	Double acting, Single rod
<b>Bore size (mm)</b>	ø20, ø25, ø32, ø40
<b>Max. operating pressure</b>	1.0 MPa
<b>Min. operating pressure</b>	0.05 MPa
<b>Cushion</b>	Rubber bumper, Air cushion
<b>Relief port size</b>	M5 x 0.8
<b>Piston speed</b>	30 to 400 mm/s
<b>Mounting</b>	Basic, Axial foot, Rod flange, Head flange, Boss-cut

\* Auto switch can be mounted.

For detailed specifications about the clean series, refer to the "Pneumatic Clean Series" (CAT.E02-23).

## Construction

ø20, ø25

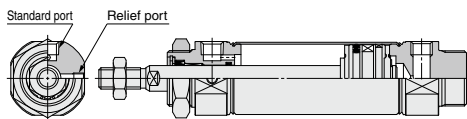

ø32, ø40



## Water Resistant

CDM2 Mounting type Bore size Port thread type R - Stroke A **Z** - M9BA XC6

• With auto switch (Built-in magnet)

<b>Water resistant cylinder</b>	
<b>R</b>	NBR seals (Nitrile rubber)
<b>V</b>	FKM seals (Fluororubber)

**Cushion**

<b>Nil</b>	Rubber bumper
<b>A</b>	Air cushion

• Made to Order

• Water resistant 2-color indicator, solid state auto switch

Ideal for use in a machine tool environment exposed to coolant mist.

Also, applicable for use in an environment with water splashing such as food processing and car wash equipment, etc.



**Dimensions** (Dimensions other than below are the same as standard type.)

**Male rod end**

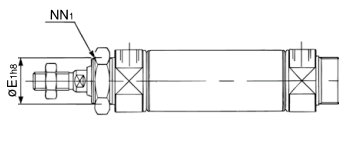

**Female rod end**

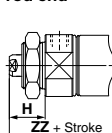

Bore size (mm)	E <sub>1</sub>	NN <sub>1</sub>	H	ZZ
<b>20</b>	22 <sup>+0.033</sup> <sub>-0.033</sub>	M22 x 1.5	24	99
<b>25</b>	*26 <sup>+0.033</sup> <sub>-0.033</sub>	*M26 x 1.5	24	99
<b>32</b>	*26 <sup>+0.033</sup> <sub>-0.033</sub>	*M26 x 1.5	24	101
<b>40</b>	*32 <sup>+0.039</sup> <sub>-0.039</sub>	*M32 x 2	26	130

※: Same as the standard type.

### Specifications

<b>Action</b>	Double acting, Single rod
<b>Bore size (mm)</b>	ø20, ø25, ø32, ø40
<b>Cushion</b>	Rubber bumper, Air cushion
<b>Auto switch mounting</b>	Band mounting type
<b>Made to Order</b>	XC6: Made of stainless steel

\* Specifications other than the above are the same as the standard type.  
\* D-A3□A/A44A/G39A/K39A/B54/B64 cannot be mounted on bore sizes ø20 and ø25 cylinder with air cushion.

### Mounting Brackets/Part No.

Mounting bracket	Min. order qty	Bore size (mm)		Contents (for minimum order quantity)
		20		
Axial foot**	2	CM-L020C		2 feet, 1 mounting nut
Flange	1	CM-F020C		1 flange
Trunnion (with nut)	1	CM-T020C		1 trunnion, 1 trunnion nut

\* ø25 to ø40: Same as the standard type.  
\*\* Order 2 feet per cylinder.

### ⚠ Caution

**Rod seal and scraper are not replaceable.**  
• Scraper is press-fit into the rod cover, thus cannot be replaced.

**CJ1**

**CJP**

**CJ2**

**JCM**

**CM2**

**CM3**

**CG1**

**CG3**

**JMB**

**MB**

**MB1**

**CA2**

**CS1**

**CS2**

**D-□**

**-X□**

Technical Data

# CM2 Series

## Low Speed Cylinder

CM2 X Mounting type Bore size – Stroke Z  
 ↓  
 Low Speed Cylinder

Smooth operation with a little sticking and slipping at low speed. Can start smoothly with a little ejection even after being rendered for hours.



**Dimensions: Same as standard type**

For details, refer to the Best Pneumatics No. 2-3.

### Specifications

Bore size (mm)	<b>20, 25, 32, 40</b>
Type	Pneumatic
Action	Double acting, Single rod
Fluid	Air
Proof pressure	1.5 MPa
Max. operating pressure	1.0 MPa
Min. operating pressure	0.025 MPa
Ambient and fluid temperature	Without auto switch: -10 to 70°C With auto switch: -10 to 60°C (No freezing)
Cushion	Rubber bumper

### Piston Speed

Bore size (mm)	<b>20</b>	<b>25</b>	<b>32</b>	<b>40</b>	
Piston speed (mm/s)	0.5 to 300				
Allowable kinetic energy (J)	Male thread	0.27	0.4	0.65	1.2
	Female thread	0.11	0.18	0.29	0.52

## Cylinder with Stable Lubrication Function (Lube-retainer)

CDM2 Mounting Bore size M – Stroke Rod end thread Z – Pivot bracket Rod end bracket – Auto switch

• With auto switch (Built-in magnet)

• Cylinder with Stable Lubrication Function (Lube-retainer)

\* D: Available only for with auto switch.



**Dimensions: Same as standard type**

For details, refer to the Web Catalog.

### Specifications

Bore size (mm)	<b>20, 25, 32, 40</b>
Action	Double acting, Single rod
Min. operating pressure	0.1 MPa
Piston speed	50 to 750 mm/s
Cushion	Rubber bumper

\* Specifications other than the above are the same as the standard type.

## Construction

### Rubber bumper

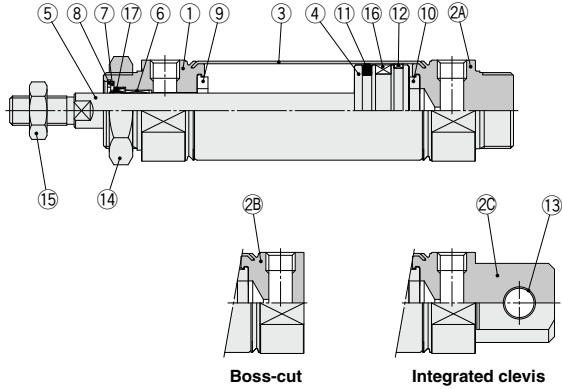

### Air-hydro

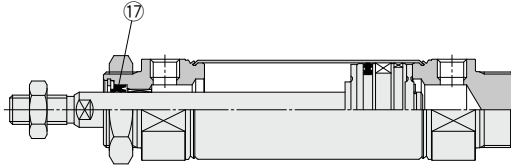

### With air cushion

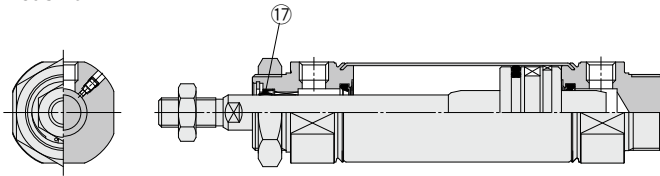

### Component Parts

No.	Description	Material	Note
1	Rod cover	Aluminum alloy	Anodized
2A	Head cover A	Aluminum alloy	Anodized
2B	Head cover B	Aluminum alloy	Anodized
2C	Head cover C	Aluminum alloy	Anodized
3	Cylinder tube	Stainless steel	
4	Piston	Aluminum alloy	
5	Piston rod	Carbon steel	Hard chrome plating
6	Bushing	Bearing alloy	
7	Seal retainer	Stainless steel	
8	Retaining ring	Carbon steel	Phosphate coating
9	Bumper	Resin	ø25 or larger is common.
10	Bumper	Resin	
11	Piston seal	NBR	

No.	Description	Material	Note
12	Wear ring	Resin	
13	Clevis bushing	Bearing alloy	
14	Mounting nut	Carbon steel	Nickel plating
15	Rod end nut	Carbon steel	Zinc chromated
16	Magnet	—	CDM2□20 to 40-□Z
17	Rod seal	NBR	

### Replacement Part: Seal

#### ●With Rubber Bumper/With Air Cushion

No.	Description	Material	Part no.			
			20	25	32	40
17	Rod seal	NBR	CM20Z-PS	CM25Z-PS	CM32Z-PS	CM40Z-PS

#### ●Air-hydro

17	Rod seal	NBR	CM2H20-PS	CM2H25-PS	CM2H32-PS	CM2H40-PS
----	----------	-----	-----------	-----------	-----------	-----------

\* Since the seal does not include a grease pack, order it separately.  
Grease pack part number: GR-S-010 (10 g)

CJ1

CJP

CJ2

JCM

**CM2**

CM3

CG1

CG3

JMB

MB

MB1

CA2

CS1

CS2

D-□

-X□

Technical Data

# CM2 Series

## Basic (Double-side Bossed) (B)

CM2B  –

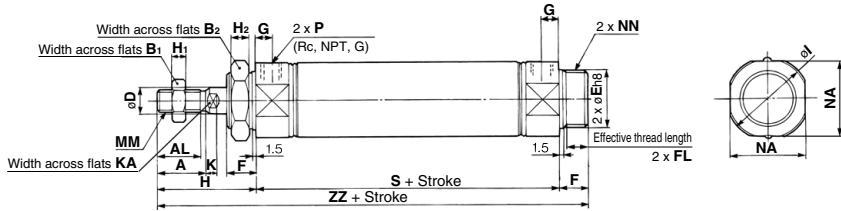

### With rod boot

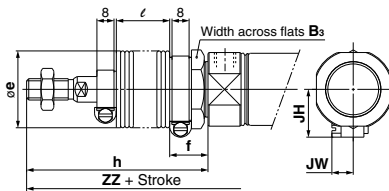

### With air cushion

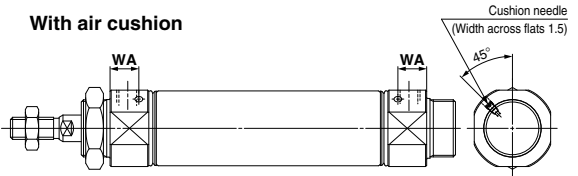

### Boss-cut

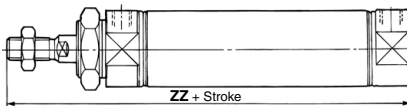

### Female rod end

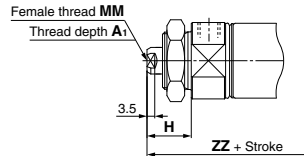

Bore size	A	AL	B <sub>1</sub>	B <sub>2</sub>	D	E	F	FL	G	H	H <sub>1</sub>	H <sub>2</sub>	I	K	KA	MM	NA	NN	P	S	ZZ
20	18	15.5	13	26	8	20 <sub>0,033</sub>	13	10.5	8	41	5	8	28	5	6	M8 x 1.25	24	M20 x 1.5	1/8	62	116
25	22	19.5	17	32	10	26 <sub>0,033</sub>	13	10.5	8	45	6	8	33.5	5.5	8	M10 x 1.25	30	M26 x 1.5	1/8	62	120
32	22	19.5	17	32	12	26 <sub>0,033</sub>	13	10.5	8	45	6	8	37.5	5.5	10	M10 x 1.25	34.5	M26 x 1.5	1/8	64	122
40	24	21	22	41	14	32 <sub>0,039</sub>	16	13.5	11	50	8	10	46.5	7	12	M14 x 1.5	42.5	M32 x 2	1/4	88	154

### With Rod Boot

Bore size	Symbol	Stroke	B <sub>s</sub>	e	f	h																l																ZZ															
						1 to 50	51 to 100	101 to 150	151 to 200	201 to 300	301 to 400	401 to 500	1 to 50	51 to 100	101 to 150	151 to 200	201 to 300	301 to 400	401 to 500	1 to 50	51 to 100	101 to 150	151 to 200	201 to 300	301 to 400	401 to 500																											
20			30	36	18	68	81	93	106	131	156	181	12.5	25	37.5	50	75	100	125	143	156	168	181	206	231	256																											
25			32	36	18	72	85	97	110	135	160	185	12.5	25	37.5	50	75	100	125	147	160	172	185	210	235	260																											
32			32	36	18	72	85	97	110	135	160	185	12.5	25	37.5	50	75	100	125	149	162	174	187	212	237	262																											
40			41	46	20	77	90	102	115	140	165	190	12.5	25	37.5	50	75	100	125	181	194	206	219	244	269	294																											

### With Rod Boot (mm)

Bore size	JH	JW
20	23.5	10.5
25	23.5	10.5
32	23.5	10.5
40	27	10.5

### Boss-cut (mm)

Bore size	ZZ															
	Without rod boot	With rod boot														
20	103	130	143	155	168	193	218	243								
25	107	134	147	159	172	197	222	247								
32	109	136	149	161	174	199	224	249								
40	138	165	178	190	203	228	253	278								

### Female Rod End (mm)

Bore size	A <sub>1</sub>	H	MM	ZZ
20	8	20	M4 x 0.7	95
25	8	20	M5 x 0.8	95
32	12	20	M6 x 1	97
40	13	21	M8 x 1.25	125

\* When female thread is used, use a thin wrench when tightening the piston rod.

\* When female thread is used, use a washer etc. to prevent the contact part at the rod end from being deformed depending on the material of the workpiece.

### With Air Cushion (mm)

Bore size	WA
20	12
25	12
32	11
40	16

**Axial Foot (L)**

CM2L  Bore size -  Stroke  Z

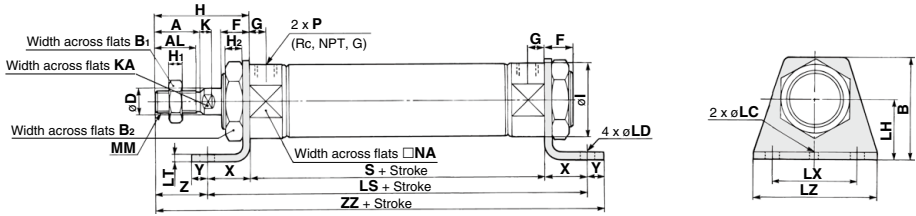

**With rod boot**

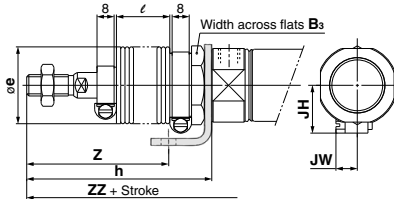

**With air cushion**

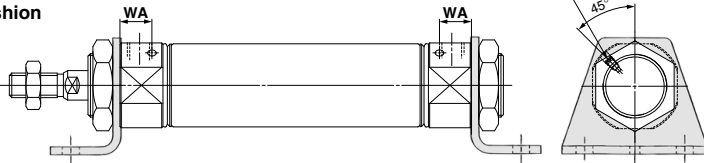

**Female rod end**

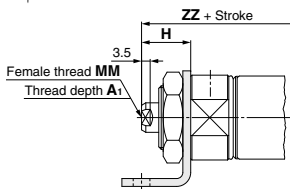

- CJ1
- CJP
- CJ2
- JCM
- CM2
- CM3
- CG1
- CG3
- JMB
- MB
- MB1
- CA2
- CS1
- CS2

(mm)

Bore size	A	AL	B	B1	B2	D	F	G	H	H1	H2	I	K	KA	LC	LD	LH	LS	LT	LX	LZ	MM	NA	P	S	X	Y	Z	ZZ
20	18	15.5	40	13	26	8	13	8	41	5	8	28	5	6	4	6.8	25	102	3.2	40	55	M8 x 1.25	24	1/8	62	20	8	21	131
25	22	19.5	47	17	32	10	13	8	45	6	8	33.5	5.5	8	4	6.8	28	102	3.2	40	55	M10 x 1.25	30	1/8	62	20	8	25	135
32	22	19.5	47	17	32	12	13	8	45	6	8	37.5	5.5	10	4	6.8	28	104	3.2	40	55	M10 x 1.25	34.5	1/8	64	20	8	25	137
40	24	21	54	22	41	14	16	11	50	8	10	46.5	7	12	4	7	30	134	3.2	55	75	M14 x 1.5	42.5	1/4	88	23	10	27	171

**With Rod Boot**

(mm)

Symbol Stroke	B3	e	h										l					Z									
			1 to 50	51 to 100	101 to 150	151 to 200	201 to 300	301 to 400	401 to 500	1 to 50	51 to 100	101 to 150	151 to 200	201 to 300	301 to 400	401 to 500	1 to 50	51 to 100	101 to 150	151 to 200	201 to 300	301 to 400	401 to 500				
20	30	36	68	81	93	106	131	156	181	12.5	25	37.5	50	75	100	125	48	61	73	86	111	136	161				
25	32	36	72	85	97	110	135	160	185	12.5	25	37.5	50	75	100	125	52	65	77	90	115	140	165				
32	32	36	72	85	97	110	135	160	185	12.5	25	37.5	50	75	100	125	52	65	77	90	115	140	165				
40	41	46	77	90	102	115	140	165	190	12.5	25	37.5	50	75	100	125	54	67	79	92	117	142	167				

**With Rod Boot**

(mm)

Symbol Stroke	ZZ								JH	JW
	1 to 50	51 to 100	101 to 150	151 to 200	201 to 300	301 to 400	401 to 500			
20	158	171	183	196	221	246	271	23.5	10.5	
25	162	175	187	200	225	250	275	23.5	10.5	
32	164	177	189	202	227	252	277	23.5	10.5	
40	198	211	223	236	261	286	311	27	10.5	

**With Air Cushion**

(mm)

Bore size	WA
20	12
25	12
32	11
40	16

**Female Rod End**

(mm)

Bore size	A1	H	MM	ZZ
20	8	20	M4 x 0.7	110
25	8	20	M5 x 0.8	110
32	12	20	M6 x 1	112
40	13	21	M8 x 1.25	142

\* When female thread is used, use a thin wrench when tightening the piston rod.

\* When female thread is used, use a washer etc. to prevent the contact part at the rod end from being deformed depending on the material of the workpiece.

\* The bracket is shipped together.

D-  
 -X

Technical Data

# CM2 Series

## Rod Flange (F)

CM2F  -

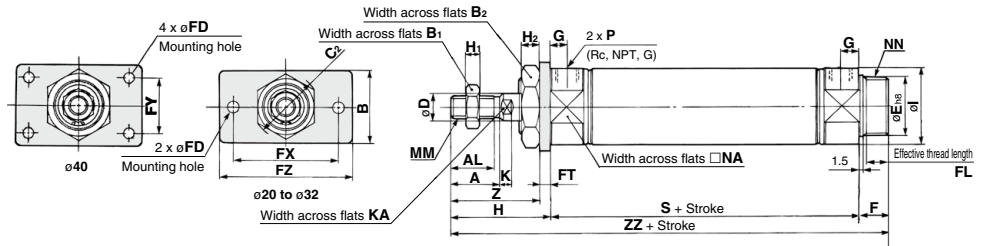

### With rod boot

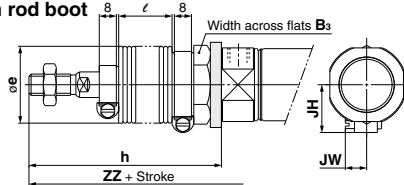

### Boss-cut

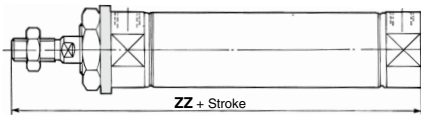

### With air cushion

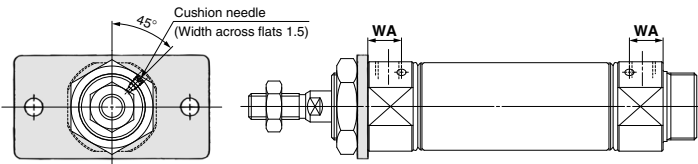

### Female rod end

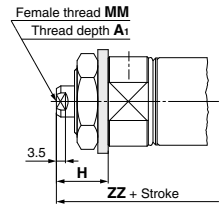

Bore size	A	AL	B	B <sub>1</sub>	B <sub>2</sub>	C <sub>2</sub>	D	E	F	FL	FD	FT	FX	FY	FZ	G	H	H <sub>1</sub>	H <sub>2</sub>	I	K	KA	MM	NA	NN	P	S	Z	ZZ
20	18	15.5	34	13	26	30	8	20 <sup>0.033</sup>	13	10.5	7	4	60	—	75	8	41	5	8	28	5	6	M8 x 1.25	24	M20 x 1.5	1/8	62	37	116
25	22	19.5	40	17	32	37	10	26 <sup>0.033</sup>	13	10.5	7	4	60	—	75	8	45	6	8	33.5	5.5	8	M10 x 1.25	30	M26 x 1.5	1/8	62	41	120
32	22	19.5	40	17	32	37	12	26 <sup>0.033</sup>	13	10.5	7	4	60	—	75	8	45	6	8	37.5	5.5	10	M10 x 1.25	34.5	M26 x 1.5	1/8	64	41	122
40	24	21	52	22	41	47.3	14	32 <sup>0.033</sup>	16	13.5	7	5	66	36	82	11	50	8	10	46.5	7	12	M14 x 1.5	42.5	M32 x 2	1/4	88	45	154

### With Rod Boot

Symbol Stroke	B <sub>3</sub>	e	h																$\ell$																ZZ															
			1 to 50	51 to 100	101 to 150	151 to 200	201 to 300	301 to 400	401 to 500	1 to 50	51 to 100	101 to 150	151 to 200	201 to 300	301 to 400	401 to 500	1 to 50	51 to 100	101 to 150	151 to 200	201 to 300	301 to 400	401 to 500																											
20	30	36	68	81	93	106	131	156	181	12.5	25	37.5	50	75	100	125	143	156	168	181	206	231	256																											
25	32	36	72	85	97	110	135	160	185	12.5	25	37.5	50	75	100	125	147	160	172	185	210	235	260																											
32	32	36	72	85	97	110	135	160	185	12.5	25	37.5	50	75	100	125	149	162	174	187	212	237	262																											
40	41	46	77	90	102	115	140	165	190	12.5	25	37.5	50	75	100	125	181	194	206	219	244	269	294																											

### With Rod Boot (mm)

Bore size	JH	JW
20	23.5	10.5
25	23.5	10.5
32	23.5	10.5
40	27	10.5

### Boss-cut (mm)

Bore size	ZZ															
	Without rod boot	1 to 50	51 to 100	101 to 150	151 to 200	201 to 300	301 to 400	401 to 500								
20	103	130	143	155	168	193	218	243								
25	107	134	147	159	172	197	222	247								
32	109	136	149	161	174	199	224	249								
40	138	165	178	190	203	228	253	278								

### Female Rod End (mm)

Bore size	A <sub>1</sub>	H	MM	ZZ
20	8	20	M4 x 0.7	95
25	8	20	M5 x 0.8	95
32	12	20	M6 x 1	97
40	13	21	M8 x 1.25	125

\* When female thread is used, use a thin wrench when tightening the piston rod.

\* When female thread is used, use a washer etc. to prevent the contact part at the rod end from being deformed depending on the material of the workpiece.

### With Air Cushion (mm)

Bore size	WA
20	12
25	12
32	11
40	16

\* The bracket is shipped together.



## Head Flange (G)

CM2G Bore size – Stroke Z

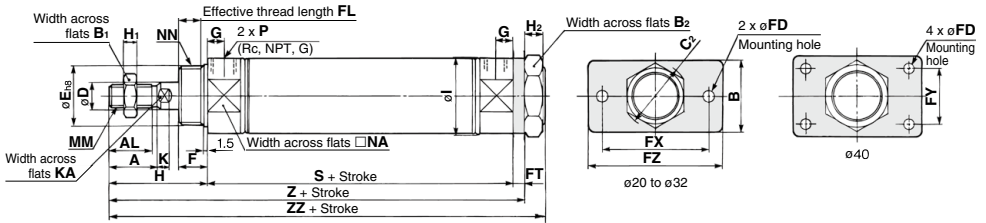

### With rod boot

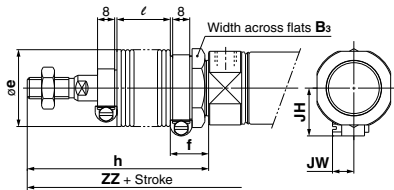

### With air cushion

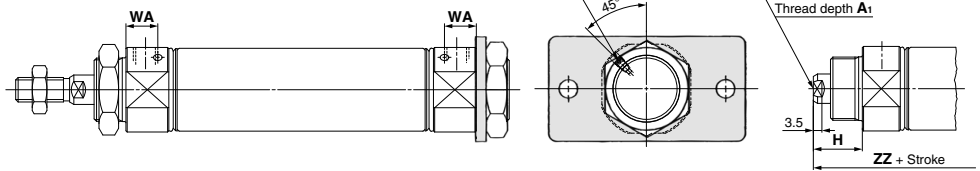

Bore size	A	AL	B	B <sub>1</sub>	B <sub>2</sub>	C <sub>2</sub>	D	E	F	FL	FD	FT	FX	FY	FZ	G	H	H <sub>1</sub>	H <sub>2</sub>	I
20	18	15.5	34	13	26	30	8	20 <sup>0.033</sup>	13	10.5	7	4	60	—	75	8	41	5	8	28
25	22	19.5	40	17	32	37	10	26 <sup>0.033</sup>	13	10.5	7	4	60	—	75	8	45	6	8	33.5
32	22	19.5	40	17	32	37	12	26 <sup>0.033</sup>	13	10.5	7	4	60	—	75	8	45	6	8	37.5
40	24	21	52	22	41	47.3	14	32 <sup>0.039</sup>	16	13.5	7	5	66	36	82	11	50	8	10	46.5

Bore size	K	KA	MM	NA	NN	P	S	Z	ZZ
20	5	6	M8 x 1.25	24	M20 x 1.5	1/8	62	107	116
25	5.5	8	M10 x 1.25	30	M26 x 1.5	1/8	62	111	120
32	5.5	10	M10 x 1.25	34.5	M26 x 1.5	1/8	64	113	122
40	7	12	M14 x 1.5	42.5	M32 x 2	1/4	88	143	154

### With Rod Boot

Bore size	Symbol	Stroke	B <sub>3</sub>	e	f	h															l															ZZ														
						1 to 50	51 to 100	101 to 150	151 to 200	201 to 300	301 to 400	401 to 500	1 to 50	51 to 100	101 to 150	151 to 200	201 to 300	301 to 400	401 to 500	1 to 50	51 to 100	101 to 150	151 to 200	201 to 300	301 to 400	401 to 500																								
20	30	36	18	68	81	93	106	131	156	181	12.5	25	37.5	50	75	100	125	143	156	168	181	206	231	256																										
25	32	36	18	72	85	97	110	135	160	185	12.5	25	37.5	50	75	100	125	147	160	172	185	210	235	260																										
32	32	36	18	72	85	97	110	135	160	185	12.5	25	37.5	50	75	100	125	149	162	174	187	212	237	262																										
40	41	46	20	77	90	102	115	140	165	190	12.5	25	37.5	50	75	100	125	181	194	206	219	244	269	294																										

### With Rod Boot (mm)

Bore size	JH	JW
20	23.5	10.5
25	23.5	10.5
32	23.5	10.5
40	27	10.5

### With Air Cushion (mm)

Bore size	WA
20	12
25	12
32	11
40	16

### Female Rod End (mm)

Bore size	A <sub>1</sub>	H	MM	ZZ
20	8	20	M4 x 0.7	95
25	8	20	M5 x 0.8	95
32	12	20	M6 x 1	97
40	13	21	M8 x 1.25	125

\* The bracket is shipped together.

- \* When female thread is used, use a thin wrench when tightening the piston rod.
- \* When female thread is used, use a washer etc. to prevent the contact part at the rod end from being deformed depending on the material of the workpiece.

CJ1  
CJP  
CJ2  
JCM  
CM2  
CM3  
CG1  
CG3  
JMB  
MB  
MB1  
CA2  
CS1  
CS2

D-□  
-X□  
Technical Data

# CM2 Series

## Single Clevis (C)

CM2C Bore size – Stroke  Z

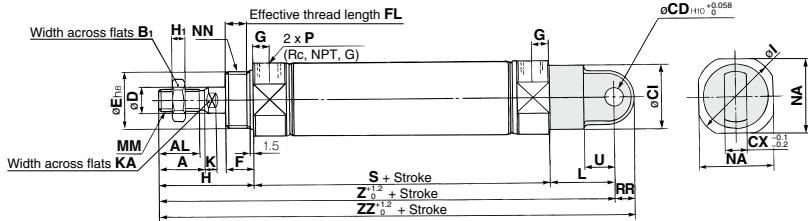

### With rod boot

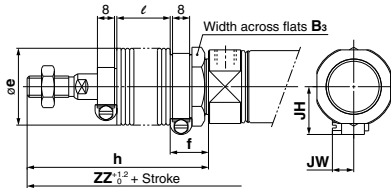

### With air cushion

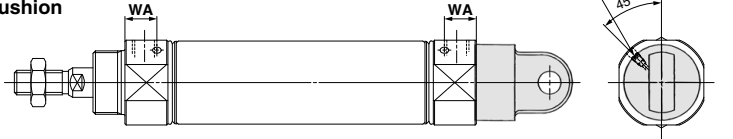

### Female rod end

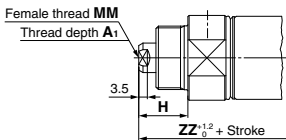

Bore size	A	AL	B <sub>1</sub>	Cl	CD	CX	D	E	F	FL	G	H	H <sub>1</sub>	I	K	KA	L	MM	NA	NN	P	RR	S	U	Z	ZZ
20	18	15.5	13	24	9	10	8	20 <sup>+0.033</sup>	13	10.5	8	41	5	28	5	6	30	M8 x 1.25	24	M20 x 1.5	1/8	9	62	14	133	142
25	22	19.5	17	30	9	10	10	26 <sup>+0.033</sup>	13	10.5	8	45	6	33.5	5.5	8	30	M10 x 1.25	30	M26 x 1.5	1/8	9	62	14	137	146
32	22	19.5	17	30	9	10	12	26 <sup>+0.033</sup>	13	10.5	8	45	6	37.5	5.5	10	30	M10 x 1.25	34.5	M26 x 1.5	1/8	9	64	14	139	148
40	24	21	22	38	10	15	14	32 <sup>+0.039</sup>	16	13.5	11	50	8	46.5	7	12	39	M14 x 1.5	42.5	M32 x 2	1/4	11	88	18	177	188

(mm)

### With Rod Boot

Symbol Stroke	B <sub>3</sub>	e	f	h								l				Z								
				1 to 50	51 to 100	101 to 150	151 to 200	201 to 300	301 to 400	401 to 500	1 to 50	51 to 100	101 to 150	151 to 200	201 to 300	301 to 400	401 to 500	1 to 50	51 to 100	101 to 150	151 to 200	201 to 300	301 to 400	401 to 500
20	30	36	18	68	81	93	106	131	156	181	12.5	25	37.5	50	75	100	125	160	173	185	198	223	248	273
25	32	36	18	72	85	97	110	135	160	185	12.5	25	37.5	50	75	100	125	164	177	189	202	227	252	277
32	32	36	18	72	85	97	110	135	160	185	12.5	25	37.5	50	75	100	125	166	179	191	204	229	254	279
40	41	46	20	77	90	102	115	140	165	190	12.5	25	37.5	50	75	100	125	204	217	229	242	267	292	317

(mm)

### With Rod Boot

Symbol Stroke	ZZ								JH		JW	
	1 to 50	51 to 100	101 to 150	151 to 200	201 to 300	301 to 400	401 to 500	23.5	10.5	23.5	10.5	
20	169	182	194	207	232	257	282	23.5	10.5	23.5	10.5	
25	173	186	198	211	236	261	286	23.5	10.5	23.5	10.5	
32	175	188	200	213	238	263	288	23.5	10.5	23.5	10.5	
40	215	228	240	253	278	303	328	27	10.5	27	10.5	

### With Air Cushion (mm)

Bore size	WA
20	12
25	12
32	11
40	16

### Female Rod End (mm)

Bore size	A <sub>1</sub>	H	MM	ZZ
20	8	20	M4 x 0.7	121
25	8	20	M5 x 0.8	121
32	12	20	M6 x 1	123
40	13	21	M8 x 1.25	159

\* When female thread is used, use a thin wrench when tightening the piston rod.

\* When female thread is used, use a washer etc. to prevent the contact part at the rod end from being deformed depending on the material of the workpiece.

**Double Clevis (D)**

CM2D Bore size – Stroke Z

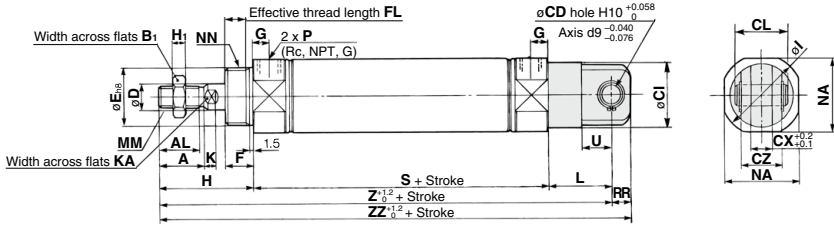

**With rod boot**

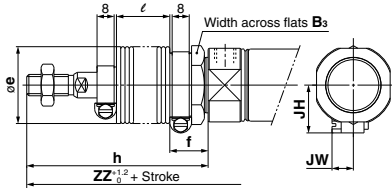

**With air cushion**

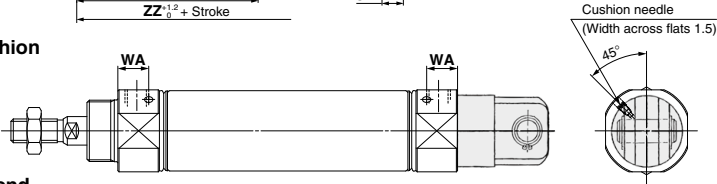

**Female rod end**

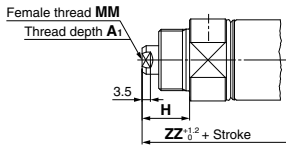

Bore size	A	AL	B <sub>1</sub>	CD	CL	CX	CZ	D	E	F	FL	G	H	H <sub>1</sub>	I	K	KA	L	MM	NA	NN	P	RR	S	U	Z	ZZ	
20	18	15.5	13	9	24	25	10	19	8	20 <sub>-0.033</sub>	13	10.5	8	41	5	28	5	6	30	M8 x 1.25	24	M20 x 1.5	1/8	9	62	14	133	142
25	22	19.5	17	9	30	25	10	19	10	26 <sub>-0.033</sub>	13	10.5	8	45	6	33.5	5.5	8	30	M10 x 1.25	30	M26 x 1.5	1/8	9	62	14	137	146
32	22	19.5	17	9	30	25	10	19	12	26 <sub>-0.033</sub>	13	10.5	8	45	6	37.5	5.5	10	30	M10 x 1.25	34.5	M26 x 1.5	1/8	9	64	14	139	148
40	24	21	22	10	38	41.2	15	30	14	32 <sub>-0.038</sub>	16	13.5	11	50	8	46.5	7	12	39	M14 x 1.5	42.5	M32 x 2	1/4	11	88	18	177	188

**With Rod Boot**

Bore size	B <sub>3</sub>	e	f	h								l								Z							
				1 to 50	51 to 100	101 to 150	151 to 200	201 to 300	301 to 400	401 to 500	1 to 50	51 to 100	101 to 150	151 to 200	201 to 300	301 to 400	401 to 500	1 to 50	51 to 100	101 to 150	151 to 200	201 to 300	301 to 400	401 to 500			
20	30	36	18	68	81	93	106	131	156	181	12.5	25	37.5	50	75	100	125	160	173	185	198	223	248	273			
25	32	36	18	72	85	97	110	135	160	185	12.5	25	37.5	50	75	100	125	164	177	189	202	227	252	277			
32	32	36	18	72	85	97	110	135	160	185	12.5	25	37.5	50	75	100	125	166	179	191	204	229	254	279			
40	41	46	20	77	90	102	115	140	165	190	12.5	25	37.5	50	75	100	125	204	217	229	242	267	292	317			

**With Rod Boot**

Bore size	ZZ	JH		JW					
		1 to 50	51 to 100	101 to 150					
20	169	182	194	207	232	257	282	23.5	10.5
25	173	186	198	211	236	261	286	23.5	10.5
32	175	188	200	213	238	263	288	23.5	10.5
40	215	228	240	253	278	303	328	27	10.5

**With Air Cushion (mm)**

Bore size	WA
20	12
25	12
32	11
40	16

**Female Rod End (mm)**

Bore size	A <sub>1</sub>	H	MM	ZZ
20	8	20	M4 x 0.7	121
25	8	20	M5 x 0.8	121
32	12	20	M6 x 1	123
40	13	21	M8 x 1.25	159

- \* When female thread is used, use a thin wrench when tightening the piston rod.
- \* When female thread is used, use a washer etc. to prevent the contact part at the rod end from being deformed depending on the material of the workpiece.

- CJ1
- CJP
- CJ2
- JCM
- CM2
- CM3
- CG1
- CG3
- JMB
- MB
- MB1
- CA2
- CS1
- CS2

- D-□
- X□
- Technical Data

# CM2 Series

## Rod Trunnion (U)

CM2U | Bore size | – Stroke |  Z

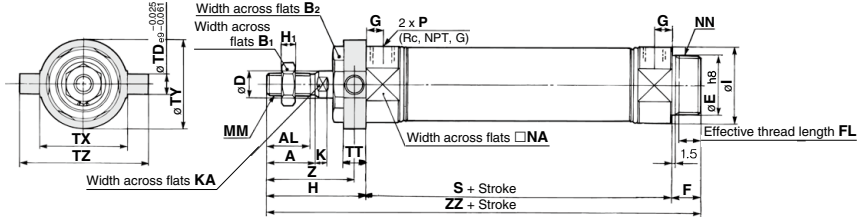

### With rod boot

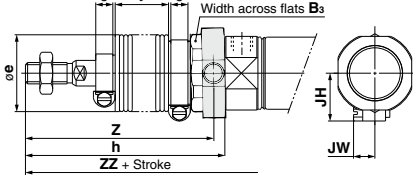

### Boss-cut

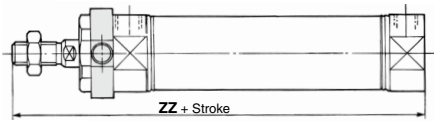

### With air cushion

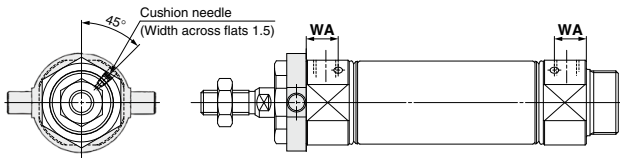

### Female rod end

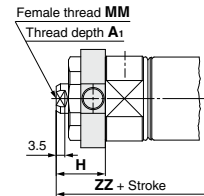

Bore size	A	AL	B <sub>1</sub>	B <sub>2</sub>	D	E	F	FL	G	H	H <sub>1</sub>	I	K	KA	MM	NA	NN	P
20	18	15.5	13	26	8	20 <sup>0</sup> <sub>-0.033</sub>	13	10.5	8	41	5	28	5	6	M8 x 1.25	24	M20 x 1.5	1/8
25	22	19.5	17	32	10	26 <sup>0</sup> <sub>-0.033</sub>	13	10.5	8	45	6	33.5	5.5	8	M10 x 1.25	30	M26 x 1.5	1/8
32	22	19.5	17	32	12	26 <sup>0</sup> <sub>-0.033</sub>	13	10.5	8	45	6	37.5	5.5	10	M10 x 1.25	34.5	M26 x 1.5	1/8
40	24	21	22	41	14	32 <sup>0</sup> <sub>-0.039</sub>	16	13.5	11	50	8	46.5	7	12	M14 x 1.5	42.5	M32 x 2	1/4

Bore size	S	TD	TT	TX	TY	TZ	Z	ZZ
20	62	8	10	32	32	52	36	116
25	62	9	10	40	40	60	40	120
32	64	9	10	40	40	60	40	122
40	88	10	11	53	53	77	44.5	154

### With Rod Boot

Bore size	Symbol	Stroke	B <sub>3</sub>	e	h							
					1 to 50	51 to 100	101 to 150	151 to 200	201 to 300	301 to 400	401 to 500	
20			30	36	68	81	93	106	131	156	181	
25			32	36	72	85	97	110	135	160	185	
32			32	36	72	85	97	110	135	160	185	
40			41	46	77	90	102	115	140	165	190	

### With Rod Boot

Bore size	Symbol	Stroke	ℓ	Z								ZZ								JH	JW					
				1 to 50	51 to 100	101 to 150	151 to 200	201 to 300	301 to 400	401 to 500	1 to 50	51 to 100	101 to 150	151 to 200	201 to 300	301 to 400	401 to 500									
20				1 to 50	51 to 100	101 to 150	151 to 200	201 to 300	301 to 400	401 to 500	1 to 50	51 to 100	101 to 150	151 to 200	201 to 300	301 to 400	401 to 500	23.5	10.5							
25				12.5	25	37.5	50	75	100	125	63	76	88	101	126	151	176	143	156	168	181	206	231	256	23.5	10.5
32				12.5	25	37.5	50	75	100	125	67	80	92	105	130	155	180	147	160	172	185	210	235	260	23.5	10.5
40				12.5	25	37.5	50	75	100	125	67	80	92	105	130	155	180	149	162	174	187	212	237	262	23.5	10.5
				12.5	25	37.5	50	75	100	125	71.5	84.5	96.5	109.5	134.5	159.5	184.5	181	194	206	219	244	269	294	27	10.5

### Boss-cut

Bore size	ZZ							
	Without rod boot		With rod boot					
	1 to 50	51 to 100	101 to 150	151 to 200	201 to 300	301 to 400	401 to 500	
20	103	130	143	155	168	193	218	243
25	107	134	147	159	172	197	222	247
32	109	136	149	161	174	199	224	249
40	138	165	178	190	203	228	253	278

### With Air Cushion

Bore size	WA
20	12
25	12
32	11
40	16

### Female Rod End

Bore size	A <sub>1</sub>	H	MM	ZZ
20	8	20	M4 x 0.7	95
25	8	20	M5 x 0.8	95
32	12	20	M6 x 1	97
40	13	21	M8 x 1.25	125

\* When female thread is used, use a thin wrench when tightening the piston rod.

\* When female thread is used, use a washer etc. to prevent the contact part at the rod end from being deformed depending on the material of the workpiece.

\* The bracket is shipped together.

## Head Trunnion (T)

CM2T  –

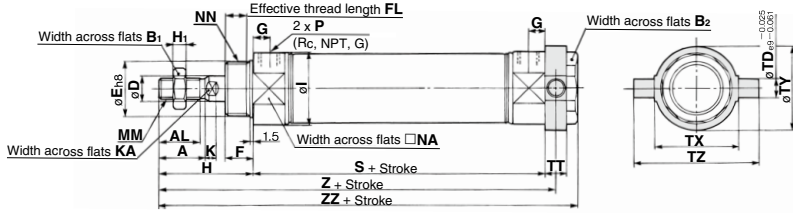

### With rod boot

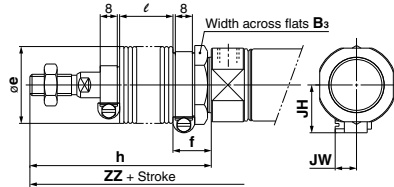

### With air cushion

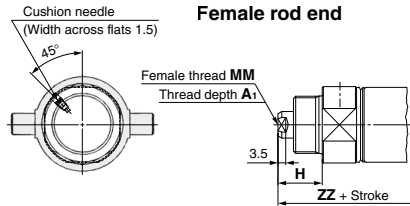
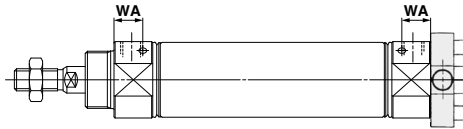

Bore size	A	AL	B <sub>1</sub>	B <sub>2</sub>	D	E	F	FL	G	H	H <sub>1</sub>	I	K	KA	MM	NA	NN	(mm)	
20	18	15.5	13	26	8	20 <sup>±0.033</sup>	13	10.5	8	41	5	28	5	6	M8 x 1.25	24	M20 x 1.5	1/8	
25	22	19.5	17	32	10	26 <sup>±0.033</sup>	13	10.5	8	45	6	33.5	5.5	8	M10 x 1.25	30	M26 x 1.5	1/8	
32	22	19.5	17	32	12	26 <sup>±0.033</sup>	13	10.5	8	45	6	37.5	5.5	10	M10 x 1.25	34.5	M26 x 1.5	1/8	
40	24	21	22	41	14	32 <sup>±0.039</sup>	16	13.5	11	50	8	46.5	7	12	M14 x 1.5	42.5	M32 x 2	1/4	

Bore size	S	TD	TT	TX	TY	TZ	Z	ZZ	(mm)	
20	62	8	10	32	32	52	108	118		
25	62	9	10	40	40	60	112	122		
32	64	9	10	40	40	60	114	124		
40	88	10	11	53	53	77	143.5	154		

Bore size	Symbol		h												(mm)	
	B <sub>3</sub>	e	f	1 to 50	51 to 100	101 to 150	151 to 200	201 to 300	301 to 400	401 to 500						
20	30	36	18	68	81	93	106	131	156	181						
25	32	36	18	72	85	97	110	135	160	185						
32	32	36	18	72	85	97	110	135	160	185						
40	41	46	20	77	90	102	115	140	165	190						

### With Rod Boot

Bore size	Symbol		Z												ZZ						JH		JW		(mm)	
	Stroke	ℓ	1 to 50	51 to 100	101 to 150	151 to 200	201 to 300	301 to 400	401 to 500	1 to 50	51 to 100	101 to 150	151 to 200	201 to 300	301 to 400	401 to 500										
20	12.5	25	37.5	50	75	100	125	135	148	160	173	198	223	248	145	158	170	183	208	233	258	23.5	10.5			
25	12.5	25	37.5	50	75	100	125	139	152	164	177	202	227	252	149	162	174	187	212	237	262	23.5	10.5			
32	12.5	25	37.5	50	75	100	125	141	154	166	179	204	229	254	151	164	176	189	214	239	264	23.5	10.5			
40	12.5	25	37.5	50	75	100	125	170.5	183.5	195.5	208.5	233.5	258.5	283.5	181	194	206	219	244	269	294	27	10.5			

### With Air Cushion (mm)

Bore size	WA
20	12
25	12
32	11
40	16

### Female Rod End (mm)

Bore size	A <sub>1</sub>	H	MM	ZZ
20	8	20	M4 x 0.7	97
25	8	20	M5 x 0.8	97
32	12	20	M6 x 1	99
40	13	21	M8 x 1.25	125

\* The bracket is shipped together.

\* When female thread is used, use a thin wrench when tightening the piston rod.

\* When female thread is used, use a washer etc. to prevent the contact part at the rod end from being deformed depending on the material of the workpiece.

# CM2 Series

## Integrated Clevis (E)

CM2E  -

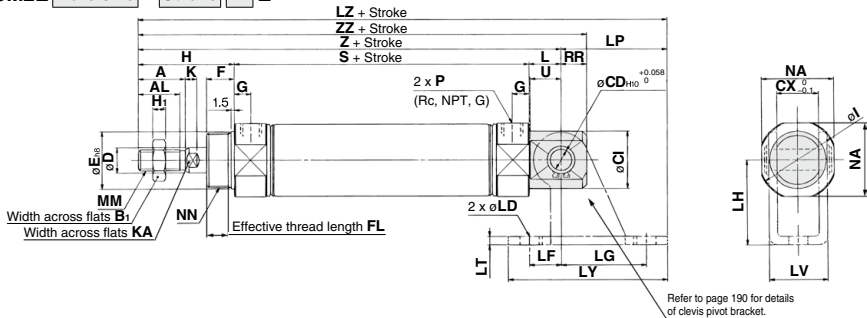

### With rod boot

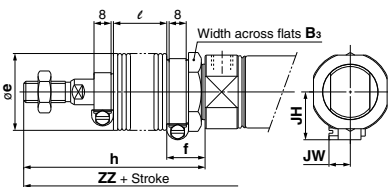

### With air cushion

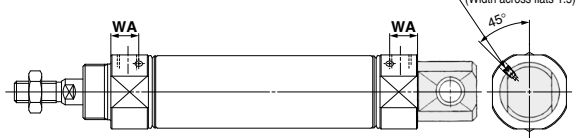

### Female rod end

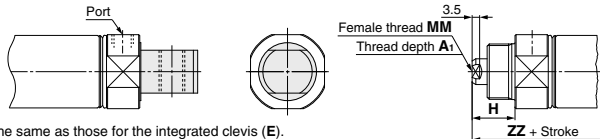

\* The dimensions are the same as those for the integrated clevis (E).

Bore size	A	AL	B <sub>1</sub>	CD	CI	CX	D	E	F	FL	G	H	H <sub>1</sub>	I	K	KA	L	MM	NA	NN
20	18	15.5	13	8	20	12	8	20 <sup>0.033</sup> <sub>0.033</sub>	13	10.5	8	41	5	28	5	6	12	M8 x 1.25	24	M20 x 1.5
25	22	19.5	17	8	22	12	10	26 <sup>0.033</sup> <sub>0.033</sub>	13	10.5	8	45	6	33.5	5.5	8	12	M10 x 1.25	30	M26 x 1.5
32	22	19.5	17	10	27	20	12	26 <sup>0.033</sup> <sub>0.033</sub>	13	10.5	8	45	6	37.5	5.5	10	15	M10 x 1.25	34.5	M26 x 1.5
40	24	21	22	10	33	20	14	32 <sup>0.039</sup> <sub>0.039</sub>	16	13.5	11	50	8	46.5	7	12	15	M14 x 1.5	42.5	M32 x 2

Bore size	P	RR	S	U	Z	ZZ
20	1/8	9	62	11.5	115	124
25	1/8	9	62	11.5	119	128
32	1/8	12	64	14.5	124	136
40	1/4	12	88	14.5	153	165

Bore size	WA
20	12
25	12
32	11
40	16

Bore size	h															
	1 to 50	51 to 100	101 to 150	151 to 200	201 to 300	301 to 400	401 to 500									
20	30	36	18	68	81	93	106	131	156	181						
25	32	36	18	72	85	97	110	135	160	185						
32	32	36	18	72	85	97	110	135	160	185						
40	41	46	20	77	90	102	115	140	165	190						

### With Rod Boot

Bore size	l																Z								ZZ								JH	JW
	1 to 50	51 to 100	101 to 150	151 to 200	201 to 300	301 to 400	401 to 500	1 to 50	51 to 100	101 to 150	151 to 200	201 to 300	301 to 400	401 to 500	1 to 50	51 to 100	101 to 150	151 to 200	201 to 300	301 to 400	401 to 500													
20	12.5	25	37.5	50	75	100	125	142	155	167	180	205	230	255	151	164	176	189	214	239	264	23.5	10.5											
25	12.5	25	37.5	50	75	100	125	146	159	171	184	209	234	259	155	168	180	193	218	243	268	23.5	10.5											
32	12.5	25	37.5	50	75	100	125	151	164	176	189	214	239	264	163	176	188	201	226	251	276	23.5	10.5											
40	12.5	25	37.5	50	75	100	125	180	193	205	218	243	268	293	192	205	217	230	255	280	305	27	10.5											

### Female Rod End

Bore size	A <sub>1</sub>	H	MM	ZZ
20	8	20	M4 x 0.7	103
25	8	20	M5 x 0.8	103
32	12	20	M6 x 1	111
40	13	21	M8 x 1.25	136

### Clevis Pivot Bracket

Bore size	LD	LF	LG	LH	LP	LT	LV	LY	LZ
20	6.8	15	30	30	37	3.2	18.4	59	152
25	6.8	15	30	30	37	3.2	18.4	59	156
32	9	15	40	40	50	4	28	75	174
40	9	15	40	40	50	4	28	75	203

\* When female thread is used, use a thin wrench when tightening the piston rod.  
 \* When female thread is used, use a washer etc. to prevent the contact part at the rod end from being deformed depending on the material of the workpiece.



# CM2 Series

# Dimensions of Accessories

## With Single Knuckle Joint (mm)

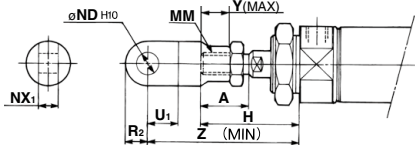

Bore size	A	H	MM	ND <sub>H10</sub>	NX <sub>1</sub>	U <sub>1</sub>	R <sub>2</sub>	Y	Z
20	18	41	M8 x 1.25	9 <sup>+0.058</sup> <sub>0</sub>	9 <sup>+0.1</sup> <sub>-0.2</sub>	14	10	11	66
25, 32	22	45	M10 x 1.25	9 <sup>+0.058</sup> <sub>0</sub>	9 <sup>+0.1</sup> <sub>-0.2</sub>	14	10	14	69
40	24	50	M14 x 1.5	12 <sup>+0.070</sup> <sub>0</sub>	16 <sup>+0.1</sup> <sub>-0.3</sub>	20	14	13	92

## With Double Knuckle Joint (mm)

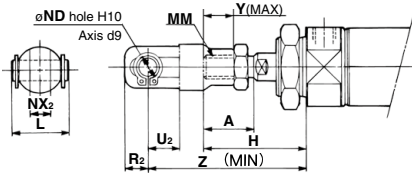

Bore size	A	H	L	MM	ND	NX <sub>2</sub>	R <sub>2</sub>	U <sub>2</sub>	Y	Z
20	18	41	25	M8 x 1.25	9	9 <sup>+0.1</sup> <sub>-0.2</sub>	10	14	11	66
25, 32	22	45	25	M10 x 1.25	9	9 <sup>+0.1</sup> <sub>-0.2</sub>	10	14	14	69
40	24	50	49.7	M14 x 1.5	12	16 <sup>+0.3</sup> <sub>-0.1</sub>	13	25	13	92

## Double Knuckle Joint (mm)

Y-020B/032B Material: Carbon steel      Y-040B Material: Cast iron

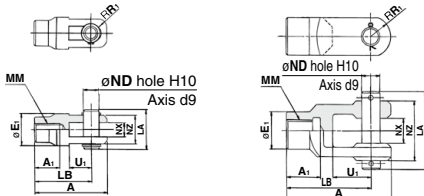

Part no.	Applicable bore size	A	A <sub>1</sub>	E <sub>1</sub>	LA	LB	MM	ND	NX	NZ	R <sub>1</sub>	U <sub>1</sub>	Included pin part number	Retaining ring Split pin size
Y-020B	20	46	16	20	25	36	M8 x 1.25	9	9 <sup>+0.2</sup> <sub>-0.3</sub>	18	5	14	CDP-1	Type C 9 for axis
Y-032B	25, 32	48	18	20	25	38	M10 x 1.25	9	9 <sup>+0.2</sup> <sub>-0.3</sub>	18	5	14	CDP-1	Type C 9 for axis
Y-040B	40	68	22	24	49.7	55	M14 x 1.5	12	16 <sup>+0.3</sup> <sub>-0.1</sub>	38	13	25	CDP-3	ø3 x 18 L

\* A knuckle pin and retaining rings (split pins for ø40) are included.

## Double Clevis Pin / Material: Carbon steel (mm)

Bore size: ø20, ø25, ø32  
CDP-1

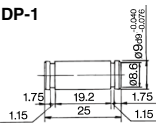

Retaining ring: Type C9 for axis

Bore size: ø40  
CDP-2

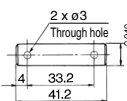

Split pin: ø3 x 18 L

\* Retaining rings (split pins for ø40) are included.

## Single Knuckle Joint (mm)

I-020B/032B Material: Carbon steel      I-040B Material: Free-cutting steel

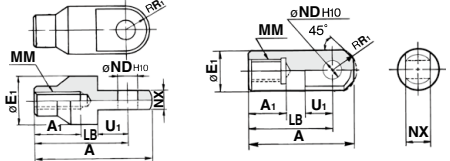

Part no.	Applicable bore size	A	A <sub>1</sub>	E <sub>1</sub>	LB	MM	ND <sub>H10</sub>	NX	R <sub>1</sub>	U <sub>1</sub>
I-020B	20	46	16	20	36	M8 x 1.25	9 <sup>+0.058</sup> <sub>0</sub>	9 <sup>+0.1</sup> <sub>-0.2</sub>	10	14
I-032B	25, 32	48	18	20	38	M10 x 1.25	9 <sup>+0.058</sup> <sub>0</sub>	9 <sup>+0.1</sup> <sub>-0.2</sub>	10	14
I-040B	40	69	22	24	55	M14 x 1.5	12 <sup>+0.070</sup> <sub>0</sub>	16 <sup>+0.1</sup> <sub>-0.3</sub>	15.5	20

CJ1

CJP

CJ2

JCM

CM2

CM3

CG1

CG3

JMB

MB

MB1

CA2

CS1

CS2

## Double Knuckle Pin / Material: Carbon steel (mm)

Bore size: ø20, ø25, ø32  
CDP-1

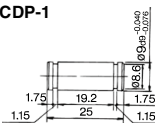

Retaining ring: Type C9 for axis

Bore size: ø40  
CDP-3

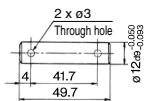

Split pin: ø3 x 18 L

\* Retaining rings (split pins for ø40) are included.

D-□

-X□

Technical Data

# CM2 Series

## Rod End Nut Material: Carbon steel (mm)

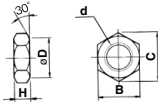

Part no.	Applicable bore size	B	C	D	d	H
NT-02	20	13	15.0	12.5	M8 x 1.25	5
NT-03	25, 32	17	19.6	16.5	M10 x 1.25	6
NT-04	40	22	25.4	21.0	M14 x 1.5	8

## Mounting Nut Material: Carbon steel (mm)

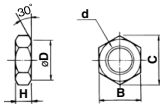

Part no.	Applicable bore size	B	C	D	d	H
SN-020B	20	26	30	25.5	M20 x 1.5	8
SN-032B	25, 32	32	37	31.5	M26 x 1.5	8
SN-040B	40	41	47.3	40.5	M32 x 2.0	10

## Trunnion Nut Material: Carbon steel (mm)

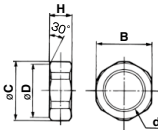

Part no.	Applicable bore size	B	C	D	d	H
TN-020B	20	26	28	25.5	M20 x 1.5	10
TN-032B	25, 32	32	34	31.5	M26 x 1.5	10
TN-040B	40	41	45	40.5	M32 x 2	10

## Mounting Brackets, Rod End Brackets, and Nut Material: Stainless Steel

### Part No. (Dimensions: Same as standard type)

Bore size (mm)	Foot	Flange	Single knuckle joint	Double knuckle joint*	Mounting nut	Rod end nut
20	CM-L020BSUS	CM-F020BSUS	I-020BSUS	Y-020BSUS	SN-020BSUS	NT-02SUS
25, 32	CM-L032BSUS	CM-F032BSUS	I-032BSUS	Y-032BSUS	SN-032BSUS	NT-03SUS
40	CM-L040BSUS	CM-F040BSUS	I-040BSUS	Y-040BSUS	SN-040BSUS	NT-04SUS

\* A knuckle pin and retaining rings are shipped together. Refer to the XC27 for details on stainless steel double clevis pins and double knuckle pins. The accessories need to be ordered separately from the cylinder.

## Clevis Pivot Bracket (For CM2E(V)) (mm)

Material: Carbon steel

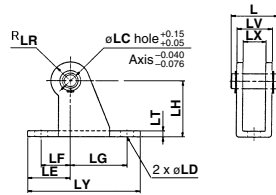

Part no.	Applicable bore size	L	LC	LD	LE	LF	LG	LH	LR
CM-E020B	20, 25	24.5	8	6.8	22	15	30	30	10
CM-E032B	32, 40	34	10	9	25	15	40	40	13

Part no.	Applicable bore size	LT	LX	LY	LV	Included pin part no.
CM-E020B	20, 25	3.2	12	59	18.4	CD-S02
CM-E032B	32, 40	4	20	75	28	CD-S03

Note 1) A clevis pivot bracket pin and retaining rings are included.  
 Note 2) It cannot be used for the single clevis (CM2C) and the double clevis (CM2D).

## Clevis Pivot Bracket Pin (For CM2E(V)) (mm)

Material: Carbon steel

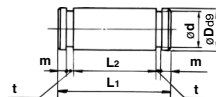

Part no.	Applicable bore size	Dd9	d	L1	L2	m	t	Included retaining ring
CD-S02	20, 25	8 <sup>+0.040</sup> <sub>-0.076</sub>	7.6	24.5	19.5	1.6	0.9	Type C 8 for axis
CD-S03	32, 40	10 <sup>+0.040</sup> <sub>-0.076</sub>	9.6	34	29	1.35	1.15	Type C 10 for axis

Note) Retaining rings are included.

### With Single Clevis

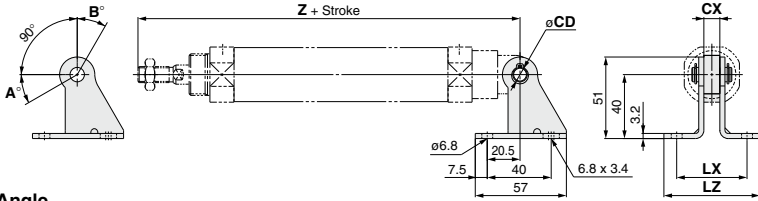

#### Rotation Angle

Bore size (mm)	A°	B°	A° + B° + 90°
20	25	85	200
25, 32	21	81	192
40	26	86	202

Mounting	Part no.	Applicable bore size	CX	Z + Stroke	CD	LX	LZ
CM2C (Single clevis)	CM-B032	20	10	133	9	44	60
		25		137			
		32		139			
	CM-B040	40	15	177	10	49	65

Note) A pivot bracket pin and retaining rings are not included with the pivot bracket.

### With Rod Trunnion

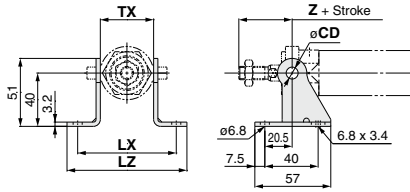

### With Head Trunnion

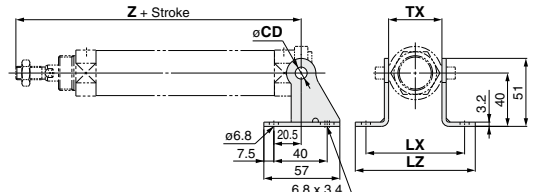

Mounting	Part no.	Applicable bore size	TX	Rod trunnion	Head trunnion	CD	LX	LZ
				Z + Stroke	Z + Stroke			
CM2U/CM2T (Rod/Head trunnion)	CM-B020	20	32	36	108	8	66	82
	CM-B032	25	40	40	112	9	74	90
		32			114			
	CM-B040	40	53	44.5	143.5	10	87	103

Note) A pivot bracket pin and retaining rings are not included with the pivot bracket.

### Pivot Bracket

\* Pivot brackets consists of a set of two brackets.

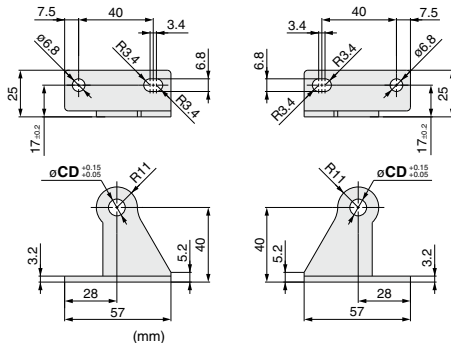

Part no.	CD
CM-B020 (Note 2)	8
CM-B032	9
CM-B040	10

Note 1) A pivot bracket pin and retaining rings are not included with the pivot bracket.  
Note 2) Only for the trunnion

### Pivot Bracket Pin (For CM2C)

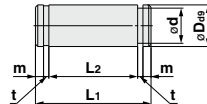

Applicable bore size	Part no.	D <sub>99</sub>	d	L <sub>1</sub>	L <sub>2</sub>	m	t	Included retaining ring
20 to 32	CDP-1	9 <sup>+0.040</sup> <sub>-0.078</sub>	8.6	25	19.2	1.75	1.15	Type C 9 for axis
40	CD-S03	10 <sup>+0.040</sup> <sub>-0.078</sub>	9.6	34	29	1.35	1.15	Type C 10 for axis

Note) Retaining rings are included with the pivot bracket pin.

CG1

CG2

CG3

JMB

MB

MB1

CA2

CS1

CS2

JMB

MB

MB1

CA2

CS1

CS2

D-□

-X□

Technical Data



# Air Cylinder: Standard Type

## Double Acting, Double Rod

# CM2W Series

ø20, ø25, ø32, ø40

RoHS

### How to Order

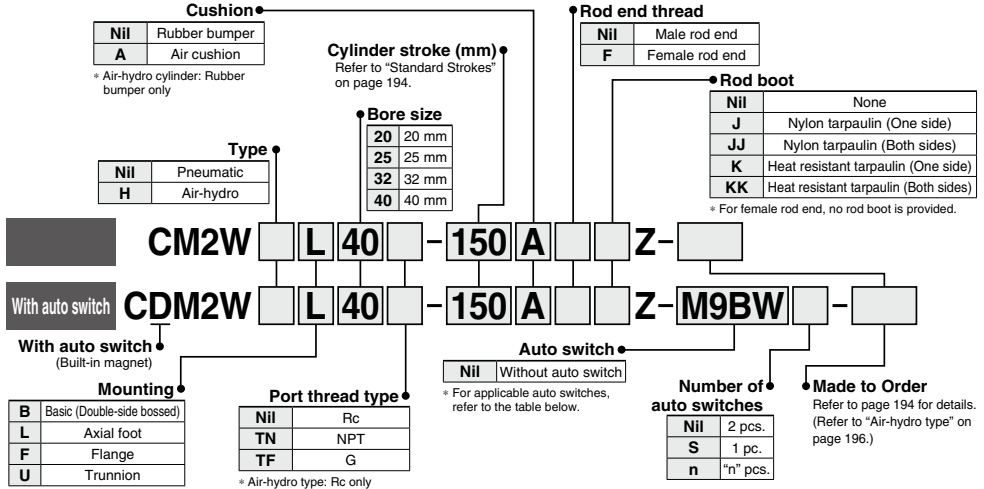

### Applicable Auto Switches

Refer to pages 1575 to 1701 for further information on auto switches.

Type	Special function	Electrical entry	Indicator light	Wiring (Output)	Load voltage		Auto switch model		Lead wire length (m)					Pre-wired connector	Applicable load		
					DC	AC	Perpendicular	In-line	0.5 (Nil)	1 (M)	3 (L)	5 (Z)	None (N)				
Solid state auto switch	—	Grommet	No	3-wire (NPN)	5 V, 12 V	—	M9NV	M9N	●	●	●	○	—	○	IC circuit		
				3-wire (PNP)			M9PV	M9P	●	●	●	○	—	○			
		Connector		2-wire	12 V	—	M9BV	M9B	●	●	●	○	—	○		—	
				Terminal conduit			2-wire	—	H7C	●	●	●	○	—			○
	Diagnostic indication (2-color indicator)	Grommet	Yes	3-wire (NPN)	24 V	5 V, 12 V	—	—	G39A	—	—	—	—	●	—	IC circuit	
				3-wire (PNP)				—	K39A	—	—	—	—	●	—		
		Water resistant (2-color indicator)		Grommet	2-wire	12 V	—	M9NVV	M9NV	●	●	●	○	—	○	IC circuit	
					3-wire (NPN)			M9PWW	M9PW	●	●	●	○	—	○		
					3-wire (PNP)			M9BWW	M9BW	●	●	●	○	—	○		
					2-wire			M9NAV*1	M9NA*1	○	○	○	○	○	○		IC circuit
3-wire (NPN)	M9PAV*1	M9PA*1	○	○	○	○	○	○	—								
3-wire (PNP)	M9BAV*1	M9BA*1	○	○	○	○	○	○		—							
2-wire	—	H7NF	●	—	●	—	—	—	○		○	IC circuit					
Reed auto switch	—	Grommet	No/Yes/No	3-wire (NPN equivalent)	—	5 V	—	A96V	A96	●	—	●	—	—	○	IC circuit	
								A93V*2	A93	●	●	●	●	—	—		—
								A90V	A90	●	—	●	—	—	—		
								—	B54	●	—	●	—	—	—		—
								—	B64	●	—	●	—	—	—		
		Connector		2-wire	24 V	12 V	—	—	—	C73C	●	—	●	—	—	IC circuit	
							—	—	—	C80C	●	—	●	—	—		
							—	—	—	A33A	—	—	—	—			●
							—	—	—	A34A	—	—	—	—	—		
							—	—	—	A44A	—	—	—	—			—
Terminal conduit	2-wire	24 V	12 V	—	—	—	B59W	●	—	●	—	—	—				
				—	—	—	—	—	—	—	—	—					
DIN terminal	2-wire	24 V	12 V	—	—	—	—	—	—	—	—		—	—			
				—	—	—	—	—	—	—	—	—					
Grommet	2-wire	24 V	12 V	—	—	—	—	—	—	—	—		—	—			
				—	—	—	—	—	—	—	—	—					

\*1 Water resistant type auto switches can be mounted on the above models, but in such case SMC cannot guarantee water resistance.  
 \* Please contact SMC regarding water resistant types with the above model numbers.  
 \* 2 1 m type lead wire is only applicable to D-A93.  
 \* Lead wire length symbols: 0.5 m ..... Nil (Example) M9NW  
 1 m ..... M (Example) M9NWM  
 3 m ..... L (Example) M9NWL  
 5 m ..... Z (Example) M9NWZ  
 None ..... N (Example) H7CN  
 \* Solid state auto switches marked with "○" are produced upon receipt of order.  
 \* Do not indicate suffix "N" for no lead wire on D-A33/A44/A93A/K39A models.

\* Since there are other applicable auto switches than listed above, refer to page 266 for details.  
 \* For details about auto switches with pre-wired connector, refer to pages 1648 and 1649.  
 \* The D-A93□□/M90□□ auto switches are shipped together, (but not assembled). (However, only the auto switch mounting brackets are assembled before shipment.)



- CJ1
- CJP
- CJ2
- JCM
- CM2
- CM3
- CG1
- CG3
- JMB
- MB
- MB1
- CA2
- CS1
- CS2

D-□  
 -X□  
 Technical Data

# CM2W Series



## Symbol

Rubber bumper

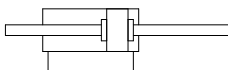

Air cushion

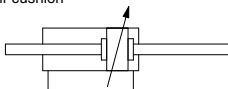

**Made to Order: Individual Specifications**  
(For details, refer to page 267.)

Symbol	Specifications
-X446	PTFE grease

## Made to Order

[Click here for details](#)

Symbol	Specifications
-XA□	Change of rod end shape
-XB6	Heat resistant cylinder (-10 to 150°C)
-XB7	Cold resistant cylinder (-40 to 70°C) <sup>*1</sup>
-XB12	External stainless steel cylinder <sup>*2</sup>
-XC3	Special port location
-XC4	With heavy duty scraper
-XC5	Heat resistant cylinder (-10 to 110°C)
-XC6	Made of stainless steel
-XC13	Auto switch rail mounting
-XC22	Fluororubber seal
-XC25	No fixed throttle of connection port <sup>*1</sup>
-XC29	Double knuckle joint with spring pin
-XC35	With coil scraper <sup>*1</sup>
-XC38	Vacuum (Rod through-hole)
-XC52	Mounting nut with set screw
-XC85	Grease for food processing equipment

<sup>\*1</sup> Rubber bumper only.

<sup>\*2</sup> The shape is the same as the current product.

## Specifications

Bore size (mm)		20	25	32	40	
<b>Action</b>		Double acting, Double rod				
<b>Fluid</b>		Air				
<b>Proof pressure</b>		1.5 MPa				
<b>Maximum operating pressure</b>		1.0 MPa				
<b>Minimum operating pressure</b>		0.08 MPa				
<b>Ambient and fluid temperature</b>		Without auto switch: -10°C to 70°C With auto switch: -10°C to 60°C (No freezing)				
<b>Lubrication</b>		Not required (Non-lube)				
<b>Stroke length tolerance</b>		$^{+1.4}_0$ mm				
<b>Piston speed</b>		Rubber bumper: 50 to 750 mm/s, Air cushion: 50 to 1000 mm/s				
<b>Cushion</b>		Rubber bumper, Air cushion				
<b>Allowable kinetic energy</b>	<b>Rubber bumper</b>	Male thread	0.27 J	0.4 J	0.65 J	1.2 J
		Female thread	0.11 J	0.18 J	0.29 J	0.52 J
	<b>Air cushion (Effective cushion length (mm))</b>	Male thread	0.54 J (11.0)	0.78 J (11.0)	1.27 J (11.0)	2.35 J (11.8)
		Female thread	0.11 J	0.18 J	0.29 J	0.52 J

## Standard Strokes

Bore size (mm)	Standard stroke <sup>Note 1)</sup> (mm)	Maximum manufacturable stroke (mm)
20	25, 50, 75, 100, 125, 150, 200, 250, 300	500
25		
32		
40		

Note 1) Other intermediate strokes can be manufactured upon receipt of order.

Manufacture of intermediate strokes at 1 mm intervals is possible.  
(Spacers are not used.)

Note 2) Applicable strokes should be confirmed according to the usage. For details, refer to "Air Cylinders Model Selection" on front matter pages. In addition, the products that exceed the standard stroke might not be able to fulfill the specifications due to the deflection etc.

## Accessories

Refer to pages 189 and 190 for accessories, since it is the same as standard type, double acting, single rod.

\* Stainless steel mounting brackets and accessories are also available.  
Refer to page 190 for details.

## Rod Boot Material

Symbol		Rod boot material	Maximum ambient temperature
One side	Both sides		
J	JJ	Nylon tarpaulin	70°C
K	KK	Heat resistant tarpaulin	110°C*

\* Maximum ambient temperature for the rod boot itself.

## Mounting Brackets/Part No.

Mounting bracket	Min. order q'ty	Bore size (mm)			Contents (for minimum order quantity)
		20	25	32	
Axial foot*	2	CM-L020B	CM-L032B	CM-L040B	2 feet, 1 mounting nut
Flange	1	CM-F020B	CM-F032B	CM-F040B	1 flange
Trunnion (with nut)	1	CM-T020B	CM-T032B	CM-T040B	1 trunnion, 1 trunnion nut

\* Order 2 feet per cylinder.

Refer to pages 262 to 266 for cylinders with auto switches.

- Auto switch proper mounting position (detection at stroke end) and its mounting height
- Minimum stroke for auto switch mounting
- Operating range
- Auto switch mounting brackets/Part no.



## Mounting and Accessories

Accessories	Standard		Option			
	Mounting nut	Rod end nut	Single knuckle joint	Double <sup>Note 2)</sup> knuckle joint	Rod boot	Pivot bracket
Basic (Double-side bossed)	● (1 pc.)	● (2 pcs.)	●	●	●	—
Axial foot	● (2 pcs.)	● (2 pcs.)	●	●	●	
Flange	● (1 pc.)	● (2 pcs.)	●	●	●	
Trunnion	● (1 pc.) <sup>Note 1)</sup>	● (2 pcs.)	●	●	●	
Note					One/Both side(s)	

Note 1) Trunnion nut is attached to the trunnion.  
Note 2) A pin and retaining rings (split pins for ø40) are shipped together with double knuckle joint.

## Weights

		(kg)			
Bore size (mm)		20	25	32	40
Basic weight	Basic (Double-side bossed)	0.16	0.25	0.32	0.65
	Axial foot	0.31	0.41	0.48	0.92
	Flange	0.22	0.34	0.41	0.77
	Trunnion	0.20	0.32	0.38	0.75
Additional weight per 50 mm of stroke		0.06	0.09	0.13	0.19
Weight reduction for female rod end		-0.02	-0.04	-0.04	-0.08
Option bracket	Single knuckle joint	0.06	0.06	0.06	0.23
	Double knuckle joint (with pin)	0.07	0.07	0.07	0.20

Calculation: (Example) **CM2WL32-100Z**  
 • Basic weight:.....0.48 (Foot, ø32)  
 • Additional weight:.....0.13/50 stroke  
 • Cylinder stroke:.....100 stroke  
 $0.48 + 0.13 \times 100/50 = 0.74 \text{ kg}$

## ⚠ Precautions

Be sure to read this before handling the products. Refer to back page 50 for Safety Instructions and pages 3 to 12 for Actuator and Auto Switch Precautions.

### Handling

#### ⚠ Warning

- Do not rotate the cover.**  
If a cover is rotated when installing a cylinder or screwing a fitting into the port, it is likely to damage the junction part with cover.
- Do not operate with the cushion needle in a fully closed condition.**  
Using it in the fully closed state will cause the cushion seal to be damaged. When adjusting the cushion needle, use the "Hexagon wrench key: nominal size 1.5".
- Do not open the cushion needle wide excessively.**  
If the cushion needle were set to be completely wide (more than 3 turns from fully closed), it would be equivalent to the cylinder with no cushion, thus making the impacts extremely high. Do not use it in such a way. Besides, using with fully open could give damage to the piston or cover.
- Do not open the cushion needle after rotating it numerous times in a row. Though uncommon, there are cases in which the cushion needle may leak air.**  
The cushion needle should be adjusted by gradually opening it while checking the operation of the cylinder cushion. In the unlikely event that air leakage occurs, return the cushion needle to the fully-closed state, and readjust the cushion needle to the desired position.
- Operate the cylinder within the specified cylinder speed, kinetic energy and lateral load at the rod end.**
- The allowable kinetic energy is different between the cylinders with male rod end and with female rod end due to the different thread sizes.**
- When female rod end is used, use a washer, etc. to prevent the contact part at the rod end from being deformed depending on the material of the work piece.**
- Do not apply excessive lateral load to the piston rod.**  
Easy checking method  
Minimum operating pressure after the cylinder is mounted to the equipment (MPa) = Minimum operating pressure of cylinder (MPa) + {Load mass (kg) x Friction coefficient of guide/Sectional area of cylinder (mm<sup>2</sup>)}  
If smooth operation is confirmed within the above value, the load on the cylinder is the resistance of the thrust only and it can be judged as having no lateral load.

#### ⚠ Caution

- Not able to disassemble.**  
Cover and cylinder tube are connected to each other by caulking method, thus making it impossible to disassemble. Therefore, internal parts of a cylinder other than rod seal are not replaceable.
- Use caution to the popping of a retaining ring.**  
When replacing rod seals and removing and mounting a retaining ring, use a proper tool (retaining ring plier: tool for installing a type C retaining ring). Even if a proper tool is used, it is likely to inflict damage to a human body or peripheral equipment, as a retaining ring may be flown out of the tip of a plier. Be much careful with the popping of a retaining ring. Be-sides, be certain that a retaining ring is placed firmly into the groove of rod cover before supplying air at the time of installment.
- Do not touch the cylinder during operation.**  
Use caution when handling a cylinder, which is running at a high speed and a high frequency, because the surface of a cylinder tube could get so hot enough as to cause you get burned.
- Do not use the air cylinder as an air-hydro cylinder.**  
If it uses turbine oil in place of fluids for cylinder, it may result in oil leak.
- Combine the rod end section, so that a rod boot might not be twisted.**  
If a rod boot is installed with being twisted when installing a cylinder, it will cause a rod boot to fail during operation.
- The base oil of grease may seep out.**  
The base oil of grease in the cylinder may seep out of the tube, cover, or crimped part depending on the operating conditions (ambient temperature 40°C or more, pressurized condition, low frequency operation).
- The oil stuck to the cylinder is grease.**
- When rod end female thread is used, use a thin wrench when tightening the piston rod.**
- When using a rod end bracket, make sure it does not interfere with other brackets, workpieces and rod section, etc.**

CJ1

CJP

CJ2

JCM

CM2

CM3

CG1

CG3

JMB

MB

MB1

CA2

CS1

CS2

D-□

-X□

Technical Data

# CM2W Series

## Built-in One-touch Fittings (The shape is the same as the current product.)

CM2W Mounting type Bore size F — Stroke

↓ Built-in One-touch fittings

This type has the One-touch fitting integrated in a cylinder, which enables to reduce the piping labor and installing space dramatically.



### Specifications

Action	Double acting, Double rod
Bore size (mm)	ø20, ø25, ø32, ø40
Max. operating pressure	1.0 MPa
Min. operating pressure	0.08 MPa
Cushion	Rubber bumper
Piping	One-touch fittings
Piston speed	50 to 750 mm/s
Mounting	Basic, Axial foot, Flange, Trunnion

\* Auto switch can be mounted.

### Applicable Tubing O.D./I.D.

Bore size (mm)	20	25	32	40
Applicable tubing O.D./I.D. (mm)	6/4	6/4	6/4	8/6
Applicable tubing material	Can be used for either nylon, soft nylon or polyurethane tubing.			

### ⚠ Caution

- One-touch fitting cannot be replaced.
  - One-touch fitting is press-fit into the cover, thus cannot be replaced.
- Refer to Fittings and Tubing Precautions (Best Pneumatics No. 7) for handling One-touch fittings.

## Air-hydro

CM2WH Mounting type Bore size — Stroke Rod boot Z — Made to Order

↓ Air-hydro

A low hydraulic pressure cylinder used at a pressures of 1.0 MPa or below.

Through the concurrent use of the CC series air-hydro unit, it is possible to operate at a constant or low speeds or to effect an intermediate stop, just like a hydraulic unit, while using pneumatic equipment such as a valve.



- For construction, refer to page 197.
- Since the dimensions of mounting type are the same as pages 200 to 202, refer to those pages.

### Specifications

Type	Air-hydro type
Fluid	Turbine oil
Action	Double acting, Double rod
Bore size (mm)	ø20, ø25, ø32, ø40
Proof pressure	1.5 MPa
Max. operating pressure	1.0 MPa
Min. operating pressure	0.18 MPa
Piston speed	15 to 300 mm/s
Ambient and fluid temperature	+5 to +60°C
Stroke length tolerance	+1.4 0 mm
Cushion	Rubber bumper (Standard equipment)
Mounting	Basic, Axial foot, Flange, Trunnion
Made to Order**	-XA□ Change of rod end shape

\* Auto switch can be mounted.

\*\* For details, refer to pages 1703 to 1896.

**Clean Series**

10-CM2W Mounting type Bore size – Stroke Z

• Clean Series (With relief port)

The type which is applicable for using inside the clean room graded ISO Class 4 by making an actuator's rod section a double seal construction and discharging by relief port directly to the outside of clean room.



For detailed specifications about the clean series, refer to the "Pneumatic Clean Series" (CAT.E02-23).

**Specifications**

Action	Double acting, Double rod
Bore size (mm)	ø20, ø25, ø32, ø40
Max. operating pressure	1.0 MPa
Min. operating pressure	0.08 MPa
Cushion	Rubber bumper
Relief port size	M5 x 0.8
Piston speed	30 to 400 mm/s
Mounting	Basic, Axial foot, Flange

\* Auto switch can be mounted.

**Construction**

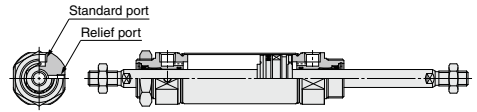

ø20, ø25

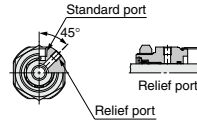

ø32, ø40

CJ1

CJP

CJ2

JCM

**CM2**

CM3

CG1

CG3

JMB

MB

MB1

CA2

CS1

CS2

D-□

-X□

Technical Data

# CM2W Series

## Construction

### Rubber bumper

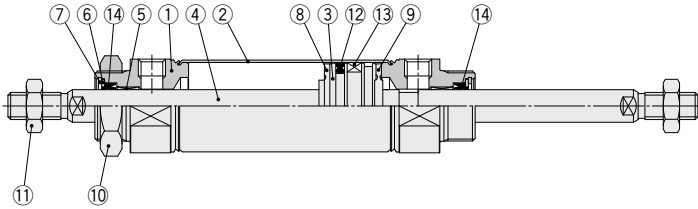

### Air-hydro

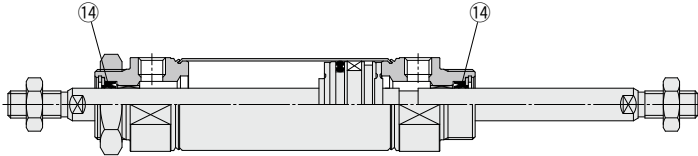

### With air cushion

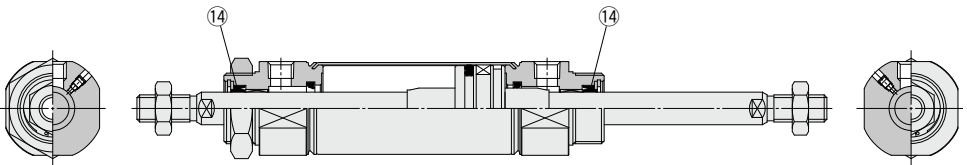

### Component Parts

No.	Description	Material	Note
1	Rod cover	Aluminum alloy	Anodized
2	Cylinder tube	Stainless steel	
3	Piston	Aluminum alloy	
4	Piston rod	Carbon steel	Hard chrome plating
5	Bushing	Bearing alloy	
6	Seal retainer	Stainless steel	
7	Retaining ring	Carbon steel	Phosphate coating
8	Bumper	Resin	
9	Bumper	Resin	
10	Mounting nut	Carbon steel	
11	Rod end nut	Carbon steel	
12	Piston seal	NBR	Nickel plating
13	Magnet	—	CDM2W□20 to 40-□Z
14	Rod seal	NBR	

### Replacement Part: Seal

● With Rubber Bumper/With Air Cushion				Part no.			
No.	Description	Material	20	25	32	40	
14	Rod seal	NBR	CM20Z-PS	CM25Z-PS	CM32Z-PS	CM40Z-PS	

  

● Air-hydro				Part no.			
No.	Description	Material	20	25	32	40	
14	Rod seal	NBR	CM2H20-PS	CM2H25-PS	CM2H32-PS	CM2H40-PS	

\* Since the seal does not include a grease pack, order it separately.  
**Grease pack part number: GR-S-010 (10 g)**

**Basic (Double-side Bossed) (B)**

CM2WB Bore size  Stroke  Z

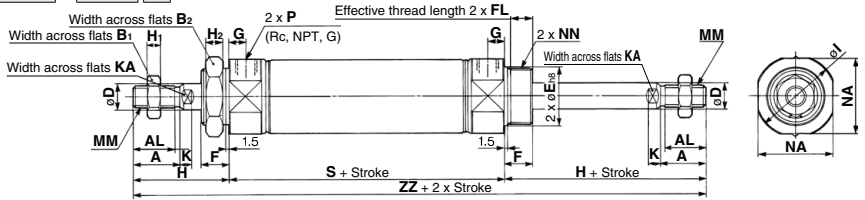

**With rod boot (One side)**

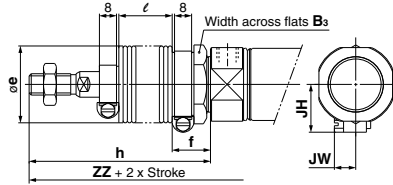

**With rod boot (Both sides)**

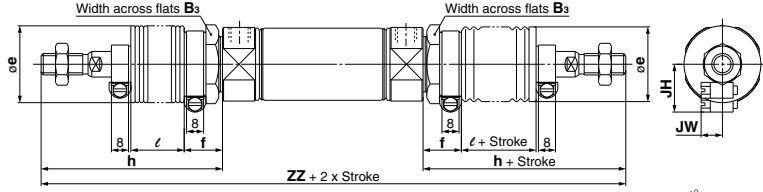

**With air cushion**

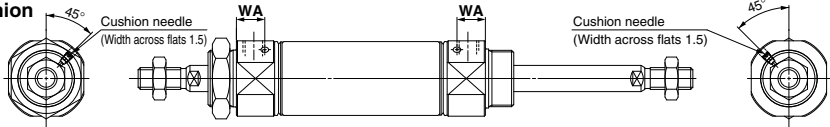

**Female rod end**

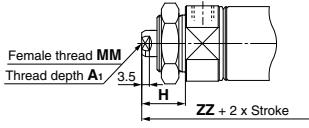

Bore size	A	AL	B <sub>1</sub>	B <sub>2</sub>	D	E	F	FL	G	H	H <sub>1</sub>	H <sub>2</sub>	I	K	KA	MM	NA	NN	P	S	ZZ
20	18	15.5	13	26	8	20 <sup>0.033</sup>	13	10.5	8	41	5	8	28	5	6	M8 x 1.25	24	M20 x 1.5	1/8	62	144
25	22	19.5	17	32	10	26 <sup>0.033</sup>	13	10.5	8	45	6	8	33.5	5.5	8	M10 x 1.25	30	M26 x 1.5	1/8	62	152
32	22	19.5	17	32	12	26 <sup>0.033</sup>	13	10.5	8	45	6	8	37.5	5.5	10	M10 x 1.25	34.5	M26 x 1.5	1/8	64	154
40	24	21	22	41	14	32 <sup>0.039</sup>	16	13.5	11	50	8	10	46.5	7	12	M14 x 1.5	42.5	M32 x 2	1/4	88	188

**With Rod Boot**

Bore size	B <sub>3</sub>	e	f	h						l						ZZ (Both sides)			
				1 to 50	51 to 100	101 to 150	151 to 200	201 to 300	1 to 50	51 to 100	101 to 150	151 to 200	201 to 300	1 to 50	51 to 100	101 to 150	151 to 200	201 to 300	
20	30	36	18	68	81	93	106	131	12.5	25	37.5	50	75	198	224	248	274	324	
25	32	36	18	72	85	97	110	135	12.5	25	37.5	50	75	206	232	256	282	332	
32	32	36	18	72	85	97	110	135	12.5	25	37.5	50	75	208	234	258	284	334	
40	41	46	20	77	90	102	115	140	12.5	25	37.5	50	75	242	268	292	318	368	

**With Rod Boot**

Bore size	ZZ (One side)					JH	JW
	1 to 50	51 to 100	101 to 150	151 to 200	201 to 300		
20	171	184	196	209	234	23.5	10.5
25	179	192	204	217	242	23.5	10.5
32	181	194	206	219	244	23.5	10.5
40	215	228	240	253	278	27	10.5

**With Air Cushion (mm)**

Bore size	WA
20	12
25	12
32	11
40	16

**Female Rod End**

Bore size	A <sub>1</sub>	H	MM	ZZ
20	8	20	M4 x 0.7	102
25	8	20	M5 x 0.8	102
32	12	20	M6 x 1	104
40	13	21	M8 x 1.25	130

\* When female thread is used, use a thin wrench when tightening the piston rod.  
\* When female thread is used, use a washer etc. to prevent the contact part at the rod end from being deformed depending on the material of the workpiece.

- CJ1
- CJP
- CJ2
- JCM
- CM2
- CM3
- CG1
- CG3
- JMB
- MB
- MB1
- CA2
- CS1
- CS2

- D-
- X

Technical Data

# CM2W Series

## Axial Foot (L)

CM2WL  -

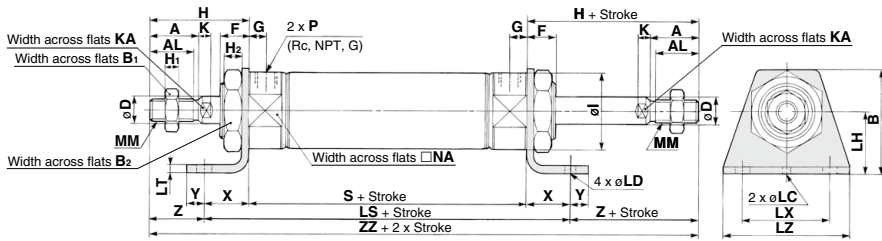

## With air cushion

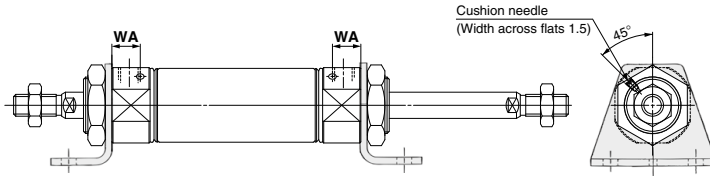

## Female rod end

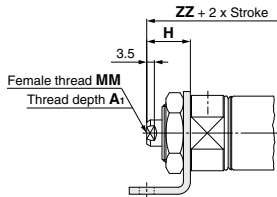

Bore size	A	AL	B	B <sub>1</sub>	B <sub>2</sub>	D	F	G	H	H <sub>1</sub>	H <sub>2</sub>	I	K	KA	LC	LD	LH	LS	LT	LX	LZ	MM	NA	P	S	X	Y	Z	ZZ
20	18	15.5	40	13	26	8	13	8	41	5	8	28	5	6	4	6.8	25	102	3.2	40	55	M8 x 1.25	24	1/8	62	20	8	21	144
25	22	19.5	47	17	32	10	13	8	45	6	8	33.5	5.5	8	4	6.8	28	102	3.2	40	55	M10 x 1.25	30	1/8	62	20	8	25	152
32	22	19.5	47	17	32	12	13	8	45	6	8	37.5	5.5	10	4	6.8	28	104	3.2	40	55	M10 x 1.25	34.5	1/8	64	20	8	25	154
40	24	21	54	22	41	14	16	11	50	8	10	46.5	7	12	4	7	30	134	3.2	55	75	M14 x 1.5	42.5	1/4	88	23	10	27	188

## With Air Cushion (mm)

Bore size	WA
20	12
25	12
32	11
40	16

## Female Rod End (mm)

Bore size	A <sub>1</sub>	H	MM	ZZ
20	8	20	M4 x 0.7	102
25	8	20	M5 x 0.8	102
32	12	20	M6 x 1	104
40	13	21	M8 x 1.25	130

\* In the case of with rod boot, refer to basic type on page 199.  
\* The bracket is shipped together.

\* When female thread is used, use a thin wrench when tightening the piston rod.

\* When female thread is used, use a washer etc. to prevent the contact part at the rod end from being deformed depending on the material of the workpiece.

**Flange (F)**

CM2WF Bore size  - Stroke  Z

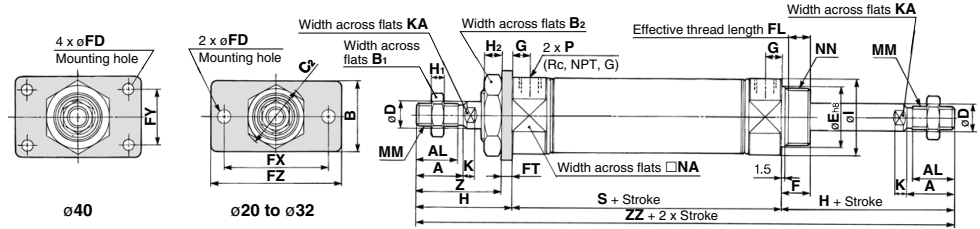

**With air cushion**

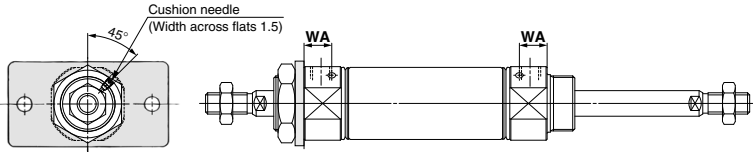

**Female rod end**

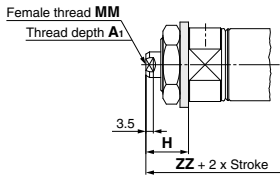

Bore size	A	AL	B	B <sub>1</sub>	B <sub>2</sub>	C <sub>2</sub>	D	E	F	FD	FL	FT	FX	FY	FZ	G	H	H <sub>1</sub>	H <sub>2</sub>	I	K	KA	MM
20	18	15.5	34	13	26	30	8	20 <sup>0</sup> <sub>-0.033</sub>	13	7	10.5	4	60	—	75	8	41	5	8	28	5	6	M8 x 1.25
25	22	19.5	40	17	32	37	10	26 <sup>0</sup> <sub>-0.033</sub>	13	7	10.5	4	60	—	75	8	45	6	8	33.5	5.5	8	M10 x 1.25
32	22	19.5	40	17	32	37	12	26 <sup>0</sup> <sub>-0.033</sub>	13	7	10.5	4	60	—	75	8	45	6	8	37.5	5.5	10	M10 x 1.25
40	24	21	52	22	41	47.3	14	32 <sup>0</sup> <sub>-0.039</sub>	16	7	13.5	5	66	36	82	11	50	8	10	46.5	7	12	M14 x 1.5

Bore size	NA	NN	P	S	Z	ZZ
20	24	M20 x 1.5	1/8	62	37	144
25	30	M26 x 1.5	1/8	62	41	152
32	34.5	M26 x 1.5	1/8	64	41	154
40	42.5	M32 x 2	1/4	88	45	188

With Air Cushion (mm)	
Bore size	WA
20	12
25	12
32	11
40	16

Female Rod End (mm)			
Bore size	A <sub>1</sub>	H	ZZ
20	8	20	M4 x 0.7
25	8	20	M5 x 0.8
32	12	20	M6 x 1
40	13	21	M8 x 1.25

\* In the case of with rod boot, refer to basic type on page 199.  
\* The bracket is shipped together.

\* When female thread is used, use a thin wrench when tightening the piston rod.

\* When female thread is used, use a washer etc. to prevent the contact part at the rod end from being deformed depending on the material of the workpiece.

- CJ1
- CJP
- CJ2
- JCM
- CM2
- CM3
- CG1
- CG3
- JMB
- MB
- MB1
- CA2
- CS1
- CS2

- D-
- X
- Technical Data

# CM2W Series

## Trunnion (U)

CM2WU [Bore size] – [Stroke] Z

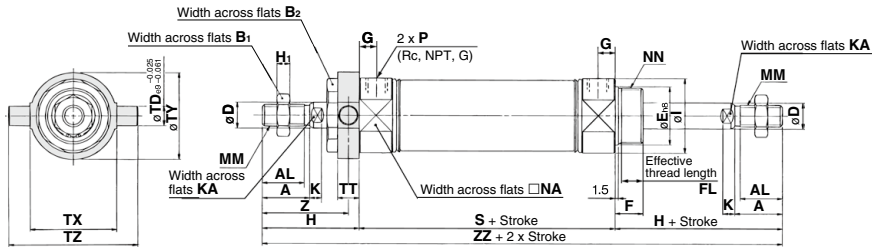

### With air cushion

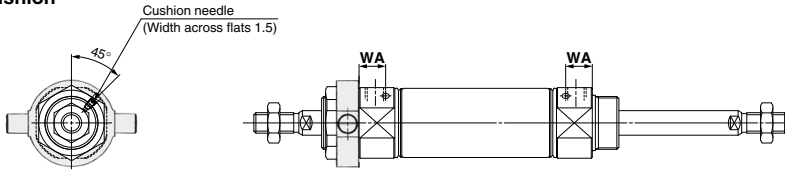

### Female rod end

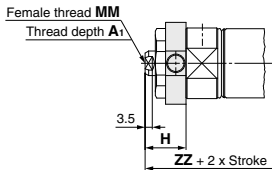

Bore size	A	AL	B <sub>1</sub>	B <sub>2</sub>	D	E	F	FL	G	H	H <sub>1</sub>	I	K	KA	MM	NA	NN	P	S	TD
20	18	15.5	13	26	8	20 <sup>0</sup> <sub>-0.033</sub>	13	10.5	8	41	5	28	5	6	M8 x 1.25	24	M20 x 1.5	1/8	62	8
25	22	19.5	17	32	10	26 <sup>0</sup> <sub>-0.033</sub>	13	10.5	8	45	6	33.5	5.5	8	M10 x 1.25	30	M26 x 1.5	1/8	62	9
32	22	19.5	17	32	12	26 <sup>0</sup> <sub>-0.033</sub>	13	10.5	8	45	6	37.5	5.5	10	M10 x 1.25	34.5	M26 x 1.5	1/8	64	9
40	24	21	22	41	14	32 <sup>0</sup> <sub>-0.039</sub>	16	13.5	11	50	8	46.5	7	12	M14 x 1.5	42.5	M32 x 2	1/4	88	10

Bore size	TT	TX	TY	TZ	Z	ZZ
20	10	32	32	52	36	144
25	10	40	40	60	40	152
32	10	40	40	60	40	154
40	11	53	53	77	44.5	188

With Air Cushion (mm)	
Bore size	WA
20	12
25	12
32	11
40	16

Female Rod End (mm)				
Bore size	A <sub>1</sub>	H	MM	ZZ
20	8	20	M4 x 0.7	102
25	8	20	M5 x 0.8	102
32	12	20	M6 x 1	104
40	13	21	M8 x 1.25	130

\* In the case of with rod boot, refer to basic type on page 199.

\* The bracket is shipped together.

\* When female thread is used, use a thin wrench when tightening the piston rod.

\* When female thread is used, use a washer etc. to prevent the contact part at the rod end from being deformed depending on the material of the workpiece.



# Air Cylinder: Standard Type Single Acting, Spring Return/Extend

## CM2 Series

ø20, ø25, ø32, ø40

RoHS

### How to Order

Mounting		Cylinder stroke (mm)		Pivot bracket	
B	Basic (Double-side bossed)	T	Head trunnion	Nil	None
L	Axial foot	E	Integrated clevis	N	Pivot bracket is shipped together with the product, but not assembled.
F	Rod flange	V	Integrated clevis (90°)	* Only for C, T, U, E, V, UZ mounting types.	
G	Head flange	BZ	Boss-cut/Basic	* Pivot bracket is shipped together with the product, but not assembled.	
C	Single clevis	FZ	Boss-cut/Rod flange	* Made to Order Refer to page 204 for details.	
D	Double clevis	UZ	Boss-cut/Rod trunnion		
U	Rod trunnion				

Action		Rod end thread	
S	Single acting, Spring return	Nil	Male rod end
T	Single acting, Spring extend	F	Female rod end

CM2 **B** **32** - **150** **S** **Z** - [ ] - [ ] - [ ]

With auto switch: **CDM2** **B** **32** - **150** **S** **Z** - [ ] - [ ] - **M9BW** [ ] - [ ]

Bore size		Rod end bracket		Auto switch		Number of auto switches	
20	20 mm	Nil	None	Nil	Without auto switch	Nil	2 pcs.
25	25 mm	V	Single knuckle joint	* For applicable auto switches, refer to the table below.		S	1 pc.
32	32 mm	W	Double knuckle joint			n	"n" pcs.
40	40 mm						

\* No bracket is provided for the female rod end.  
 \* A knuckle joint pin is not provided with the single knuckle joint.  
 \* Rod end bracket is shipped together with the product, but not assembled.  
 \* Not applicable to XB12.

\* Refer to "Ordering Example of Cylinder Assembly" on page 204.

### Applicable Auto Switches/Refer to pages 1575 to 1701 for further information on auto switches.

Type	Special function	Electrical entry	Indicator light	Wiring (Output)	Load voltage		Auto switch model		Lead wire length (m)					Pre-wired connector	Applicable load
					DC	AC	Perpendicular	In-line	0.5 (Nil)	1 (M)	3 (L)	5 (Z)	None (N)		
Solid state auto switch	—	Grommet	Yes	3-wire (NPN)	5 V, 12 V	—	M9NV	M9N	●	●	●	○	○	IC circuit	Relay, PLC
				3-wire (PNP)			M9PV	M9P	●	●	●	○	○		
				Connector	2-wire	12 V	M9BV	M9B	●	●	●	○	○		
		Terminal conduit			3-wire (NPN)	5 V, 12 V	—	H7C	●	—	●	●	—		
					2-wire	12 V	—	G39A	—	—	—	●	—		
		Diagnostic indication (2-color indicator)		Grommet	3-wire (NPN)	24 V	—	M9NVV	M9NV	●	●	●	○	○	
	3-wire (PNP)		5 V, 12 V		—	M9PVV	M9PV	●	●	●	○	○			
	Water resistant (2-color indicator)		2-wire	12 V	—	M9BVV	M9BV	●	●	●	○	○			
			3-wire (NPN)	5 V, 12 V	—	M9NAV <sup>*1</sup>	M9NA <sup>*1</sup>	○	○	○	○	○			
	With diagnostic output (2-color indicator)	Grommet	3-wire (PNP)	5 V, 12 V	—	M9PAV <sup>*1</sup>	M9PA <sup>*1</sup>	○	○	○	○	○			
2-wire			12 V	—	M9BAV <sup>*1</sup>	M9BA <sup>*1</sup>	○	○	○	○	○				
4-wire (NPN)		5 V, 12 V	—	—	H7NF	●	—	●	●	○	○				
		—	5 V	—	A96V	A96	●	—	●	—	—				
Reed auto switch	—	Grommet	Yes	3-wire (NPN equivalent)	24 V	12 V	—	A93V <sup>*2</sup>	A93	●	●	●	—	—	
								A90V	A90	●	—	●	—	—	
								—	B54	●	—	●	—	—	
								—	B64	●	—	●	—	—	
								—	C73C	●	—	●	—	—	
		Connector		—	24 V or less	—	C80C	●	—	●	●	—			
				Terminal conduit	—	—	A33A	—	—	—	—	●	—		
					—	100 V, 200 V	—	A34A	—	—	—	—	●	—	
					—	200 V	—	A44A	—	—	—	—	●	—	
				Grommet	—	—	B59W	●	—	●	—	—			

\*1 Water resistant type auto switches can be mounted on the above models, but in such case SMC cannot guarantee water resistance.  
 \* Please contact SMC regarding water resistant types with the above model numbers.  
 \* 2.1 m type lead wire is only applicable to D-A93.  
 \* Lead wire length symbols: 0.5 m.....Nil (Example) M9NV  
 1 m.....M (Example) M9NVW  
 3 m.....L (Example) M9NWL  
 5 m.....Z (Example) M9NVZ  
 None.....N (Example) H7CN  
 \* Solid state auto switches marked with "○" are produced upon receipt of order.  
 \* Do not indicate suffix "N" for no lead wire on D-A3□/A44A/G39A/K39A models.

\* Since there are other applicable auto switches than listed above, refer to page 266 for details.  
 \* For details about auto switches with pre-wired connector, refer to pages 1648 and 1649.  
 \* The D-A9□□/M9□□□ auto switches are shipped together, (but not assembled). (However, only the auto switch mounting brackets are assembled before shipment.)



CJ1  
CJP  
CJ2  
JCM  
CM2  
CM3  
CG1  
CG3  
JMB  
MB  
MB1  
CA2  
CS1  
CS2

D-□  
-X□

Technical Data

## Specifications

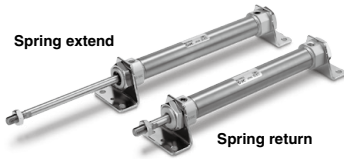

Bore size (mm)		20	25	32	40
<b>Action</b>		Single acting, Spring return/Single acting, Spring extend			
<b>Type</b>		Pneumatic			
<b>Cushion</b>		Rubber bumper			
<b>Fluid</b>		Air			
<b>Proof pressure</b>		1.5 MPa			
<b>Maximum operating pressure</b>		1.0 MPa			
<b>Minimum operating pressure</b>	Single acting, Spring return	0.18 MPa			
	Single acting, Spring extend	0.23 MPa			
<b>Ambient and fluid temperature</b>		Without auto switch: -10°C to 70°C (No freezing) With auto switch: -10°C to 60°C			
<b>Lubrication</b>		Not required (Non-lube)			
<b>Stroke length tolerance</b>		$^{+1.4}_0$ mm			
<b>Piston speed</b>		50 to 750 mm/s			
<b>Allowable kinetic energy</b>	<b>Male thread</b>	0.27 J	0.4 J	0.65 J	1.2 J
	<b>Female thread</b>	0.11 J	0.18 J	0.29 J	0.52 J

## Standard Strokes

Bore size (mm)	Standard stroke (mm) <sup>Note 1)</sup>
20	25, 50, 75, 100, 125, 150
25	25, 50, 75, 100, 125, 150
32	25, 50, 75, 100, 125, 150, 200
40	25, 50, 75, 100, 125, 150, 200, 250

Note 1) Other intermediate strokes can be manufactured upon receipt of order. Manufacture of intermediate strokes at 1 mm intervals is possible. (Spacers are not used.)

Note 2) Applicable strokes should be confirmed according to the usage. For details, refer to "Air Cylinders Model Selection" on front matter pages. In addition, the products that exceed the standard stroke might not be able to fulfill the specifications due to the deflection etc.

Note 3) Please consult with SMC for strokes which exceed the standard stroke length.

### Symbol

Single acting, Spring return, Rubber bumper

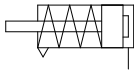

Single acting, Spring extend, Rubber bumper

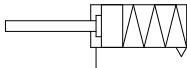

**Made to Order**  
Click here for details

Symbol	Specifications
-XA□	Change of rod end shape
-XB12	External stainless steel cylinder*
-XC3	Special port location
-XC6	Made of stainless steel
-XC13	Auto switch rail mounting
-XC20	Head cover axial port
-XC25	No fixed throttle of connection port
-XC27	Double clevis and double knuckle pins made of stainless steel
-XC29	Double knuckle joint with spring pin
-XC52	Mounting nut with set screw
-XC85	Grease for food processing equipment

\* The shape is the same as the current product.

Refer to pages 262 to 266 for cylinders with auto switches.

- Auto switch proper mounting position (detection at stroke end) and its mounting height
- Minimum stroke for auto switch mounting
- Operating range
- Auto switch mounting brackets/Part no.

### Mounting Bracket

For the mounting bracket part numbers other than basic type, refer to page 205.

\* Stainless steel mounting brackets and accessories are also available. Refer to page 190 for details.

### Theoretical Output

Refer to page 1903 (Theoretical Output 1).

### Spring Reaction Force

Refer to page 1900 (Table (3): Spring Reaction Force).

### Accessories

Refer to pages 189 and 190 for accessories, since it is the same as standard type, double acting, single rod.

## Option: Ordering Example of Cylinder Assembly

**Cylinder model: CDM2C32-150SZ-NV-M9BW**

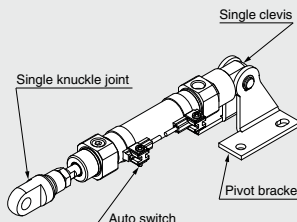

**Mounting C: Single clevis**  
**Pivot bracket N: Yes**  
**Rod end bracket V: Single knuckle joint**  
**Auto switch D-M9BW: 2 pcs.**

\* Pivot bracket, single knuckle joint and auto switch are shipped together with the product, but not assembled.

\* Pivot bracket is available only for C, T, U, E, V, UZ mounting types.  
\* No bracket is provided for the female rod end.

## Mounting and Accessories

Accessories	Body	Standard (mounted to the body)					Standard (packaged together, but not assembled)							Option				
		Mounting nut <small>Note 1)</small>	Rod end nut <small>(Male thread)</small>	Single clevis	Double clevis	Liner <small>Note 7)</small>	Mounting nut	Foot	Flange	Pivot bracket	Pivot bracket pin <small>Note 5)</small>	Double clevis pin <small>Note 5)</small>	Trunnion	Mounting nut <small>(For trunnion)</small>	Clevis pivot bracket <small>(CM2E/CM2V)</small>	Clevis pivot bracket pin <small>(CM2E/CM2V)</small>	Single knuckle joint <small>(Male thread only)</small>	Double knuckle joint <small>(Male thread only)</small>
<b>B</b> Basic (Double-side bossed)	●(1 pc.)	●(1 pc.)	●(1 pc.)	—	—	—	—	—	—	—	—	—	—	—	—	—	●	●
<b>L</b> Axial foot	●(1 pc.)	●(1 pc.) <sup>Note 2)</sup>	●(1 pc.)	—	—	—	●(1 pc.) <sup>Note 2)</sup>	●(2 pcs.)	—	—	—	—	—	—	—	—	●	●
<b>F</b> Rod flange	●(1 pc.)	●(1 pc.)	●(1 pc.)	—	—	—	—	—	—	—	—	—	—	—	—	—	●	●
<b>G</b> Head flange	●(1 pc.)	●(1 pc.)	●(1 pc.)	—	—	—	—	—	—	—	—	—	—	—	—	—	●	●
<b>C</b> Single clevis	●(1 pc.)	— <sup>Note 3)</sup>	●(1 pc.)	●(1 pc.)	—	—	●(Max. 3 pcs.) <sup>Note 3)</sup>	—	—	—	—	—	—	—	—	—	●	●
<b>D</b> Double clevis	●(1 pc.)	— <sup>Note 3)</sup>	●(1 pc.)	—	—	—	●(1 pc.)	●(Max. 3 pcs.) <sup>Note 3)</sup>	—	—	—	—	—	—	—	—	●	●
<b>U</b> Rod trunnion	●(1 pc.)	— <sup>Note 4)</sup>	●(1 pc.)	—	—	—	—	—	—	—	—	—	●(1 pc.)	●(1 pc.)	—	—	●	●
<b>T</b> Head trunnion	●(1 pc.)	— <sup>Note 4)</sup>	●(1 pc.)	—	—	—	—	—	—	—	—	—	●(1 pc.)	●(1 pc.)	—	—	●	●
<b>E</b> Integrated clevis	●(1 pc.)	— <sup>Note 3)</sup>	●(1 pc.)	—	—	—	—	—	—	—	—	—	—	—	—	—	●	●
<b>V</b> Integrated clevis (90°)	●(1 pc.)	— <sup>Note 3)</sup>	●(1 pc.)	—	—	—	—	—	—	—	—	—	—	—	—	—	●	●
<b>BZ</b> Boss-cut/Basic	●(1 pc.)	●(1 pc.)	●(1 pc.)	—	—	—	—	—	—	—	—	—	—	—	—	—	●	●
<b>FZ</b> Boss-cut/ Rod flange	●(1 pc.)	●(1 pc.)	●(1 pc.)	—	—	—	—	—	—	—	—	—	—	—	—	—	●	●
<b>UZ</b> Boss-cut/ Rod trunnion	●(1 pc.)	— <sup>Note 4)</sup>	●(1 pc.)	—	—	—	—	—	—	—	—	—	●(1 pc.)	●(1 pc.)	—	—	●	●

Note 1) Rod end nut is not provided for the female rod end.

Note 2) Two mounting nuts are packaged together.

Note 3) Mounting nut is not packaged for the clevis.

Note 4) Trunnion nut is packaged for U, T, UZ.

Note 5) Retaining rings are included.

Note 6) A pin and retaining rings (split pins for ø40) are included.

Note 7) This is the part(s) used to adjust the clevis angle. Mounting quantity can vary.

## Mounting Brackets/Part No.

Mounting bracket	Min. order qty	Bore size (mm)			Contents (for minimum order quantity)	
		20	25	32		40
Foot*	2	CM-L020B	CM-L032B		CM-L040B	2 foots, 1 mounting nut
Flange	1	CM-F020B	CM-F032B		CM-F040B	1 flange
Single clevis**	1	CM-C020B	CM-C032B		CM-C040B	1 single clevis, 3 liners
Double clevis (with pin)***	1	CM-D020B	CM-D032B		CM-D040B	1 double clevis, 3 liners, 1 clevis pin, 2 retaining rings
Double clevis pin	1	CDP-1			CDP-2	1 clevis pin, 2 retaining rings (split pins)
Trunnion (with nut)	1	CM-T020B	CM-T032B		CM-T040B	1 trunnion, 1 trunnion nut
Rod end nut	1	NT-02	NT-03		NT-04	1 rod end nut
Mounting nut	1	SN-020B	SN-032B		SN-040B	1 mounting nut
Trunnion nut	1	TN-020B	TN-032B		TN-040B	1 trunnion nut
Single knuckle joint	1	I-020B	I-032B		I-040B	1 single knuckle joint
Double knuckle joint	1	Y-020B	Y-032B		Y-040B	1 double knuckle joint, 1 knuckle pin, 2 retaining rings
Double knuckle joint pin	1	CDP-1			CDP-3	1 knuckle pin, 2 retaining rings (split pins)
Clevis pivot bracket pin (For CM2E/CM2V)	1	CD-S02		CD-S03		1 clevis pin, 2 retaining rings
Clevis pivot bracket (For CM2E/CM2V)	1	CM-E020B		CM-E032B		1 clevis pivot bracket, 1 clevis pin, 2 retaining rings
Pivot bracket (For CM2C)	1	CM-B032			CM-B040	2 pivot brackets (1 of each type)
Pivot bracket pin (For CM2C)	1	CDP-1			CD-S03	1 pin, 2 retaining rings
Pivot bracket (For CM2T/CM2U)	1	CM-B020	CM-B032		CM-B040	2 pivot brackets (1 of each type)

\* Order 2 foots per cylinder.

\*\* 3 liners are included with a clevis bracket for adjusting the mounting angle.

\*\*\* A clevis pin and retaining rings (split pins for ø40) are included.

CJ1

CJP

CJ2

JCM

CM2

CM3

CG1

CG3

JMB

MB

MB1

CA2

CS1

CS2

D-□

-X□

Technical Data

## Mounting Brackets, Accessories/Material, Surface Treatment

Segment	Description	Material	Surface treatment
Mounting brackets	Foot	Carbon steel	Nickel plating
	Flange	Carbon steel	Nickel plating
	Single clevis	Carbon steel	Nickel plating
	Double clevis	Carbon steel	Nickel plating
	Trunnion	Cast iron	Electroless nickel plating
Accessories	Rod end nut	Carbon steel	Zinc chromated
	Mounting nut	Carbon steel	Nickel plating
	Trunnion nut	Carbon steel	Nickel plating
	Clevis pivot bracket	Carbon steel	Nickel plating
	Clevis pivot bracket pin	Carbon steel	(None)
	Single knuckle joint	Carbon steel ø40: Free-cutting steel	Electroless nickel plating
	Double knuckle joint	Carbon steel ø40: Cast iron	Electroless nickel plating Metallic silver color painted for ø40
	Double clevis pin	Carbon steel	(None)
	Double knuckle joint pin	Carbon steel	(None)
	Pivot bracket	Carbon steel	Nickel plating
	Pivot bracket pin	Carbon steel	(None)

## ⚠ Precautions

**Be sure to read this before handling the products.**  
**Refer to back page 50 for Safety Instructions and pages 3 to 12 for Actuator and Auto Switch Precautions.**

## Handling

### ⚠ Warning

#### 1. Do not rotate the cover.

If a cover is rotated when installing a cylinder or screwing a fitting into the port, it is likely to damage the junction part with cover.

### ⚠ Caution

#### 1. Not able to disassemble.

Cover and cylinder tube are connected to each other by caulking method, thus making it impossible to disassemble. Therefore, internal parts of a cylinder other than rod seal are not replaceable.

#### 2. Use caution to the popping of a retaining ring.

When replacing rod seals and removing and mounting a retaining ring, use a proper tool (retaining ring plier: tool for installing a type C retaining ring). Even if a proper tool is used, it is likely to inflict damage to a human body or peripheral equipment, as a retaining ring may be flown out of the tip of a plier. Be much careful with the popping of a retaining ring. Besides, be certain that a retaining ring is placed firmly into the groove of rod cover before supplying air at the time of installment.

#### 3. Do not touch the cylinder during operation.

Use caution when handling a cylinder, which is running at a high speed and a high frequency, because the surface of a cylinder tube could get so hot enough as to cause you get burned.

#### 4. The oil stuck to the cylinder is grease.

#### 5. The base oil of grease may seep out.

#### 6. When using a rod end bracket and/or pivot bracket, make sure they do not interfere with other brackets, workpieces and rod section, etc.

## Weights

### Spring Return

(kg)

Bore size (mm)		20	25	32	40
Basic weight	25 stroke	0.20	0.30	0.42	0.77
	50 stroke	0.22	0.33	0.46	0.84
	75 stroke	0.27	0.42	0.58	1.03
	100 stroke	0.29	0.45	0.63	1.09
	125 stroke	0.35	0.54	0.76	1.29
	150 stroke	0.37	0.57	0.80	1.36
	200 stroke	—	—	0.97	1.61
	250 stroke	—	—	—	1.87
Mounting bracket weight	Foot	0.15	0.16	0.16	0.27
	Flange	0.06	0.09	0.09	0.12
	Single clevis	0.04	0.04	0.04	0.09
	Double clevis	0.05	0.06	0.06	0.13
	Trunnion	0.04	0.07	0.07	0.10
	Clevis integrated	-0.02	-0.02	-0.01	-0.04
	Boss-cut/Basic	-0.01	-0.02	-0.02	-0.03
	Boss-cut/Flange	0.05	0.07	0.07	0.09
	Boss-cut/Trunnion	0.03	0.05	0.05	0.07
	Clevis pivot bracket (with pin)	0.07	0.07	0.14	0.14
Weight reduction for female rod end		-0.01	-0.02	-0.02	-0.04
Option bracket	Single knuckle joint	0.06	0.06	0.06	0.23
	Double knuckle joint (with pin)	0.07	0.07	0.07	0.20

Calculation:

(Example) **CM2L32-100SZ** (Bore size ø32, Foot, 100 stroke)

0.63 (Basic weight) + 0.16 (Mounting bracket weight) = **0.79 kg**

### Spring Extend

(kg)

Bore size (mm)		20	25	32	40
Basic weight	25 stroke	0.19	0.29	0.40	0.74
	50 stroke	0.21	0.32	0.44	0.81
	75 stroke	0.25	0.39	0.54	0.97
	100 stroke	0.27	0.42	0.58	1.03
	125 stroke	0.32	0.49	0.69	1.20
	150 stroke	0.34	0.52	0.73	1.27
	200 stroke	—	—	0.88	1.49
	250 stroke	—	—	—	1.72
Mounting bracket weight	Foot	0.15	0.16	0.16	0.27
	Flange	0.06	0.09	0.09	0.12
	Single clevis	0.04	0.04	0.04	0.09
	Double clevis	0.05	0.06	0.06	0.13
	Trunnion	0.04	0.07	0.07	0.10
	Clevis integrated	-0.02	-0.02	-0.01	-0.04
	Boss-cut/Basic	-0.01	-0.02	-0.02	-0.03
	Boss-cut/Flange	0.05	0.07	0.07	0.09
	Boss-cut/Trunnion	0.03	0.05	0.05	0.07
	Clevis pivot bracket (with pin)	0.07	0.07	0.14	0.14
Weight reduction for female rod end		-0.01	-0.02	-0.02	-0.04
Option bracket	Single knuckle joint	0.06	0.06	0.06	0.23
	Double knuckle joint (with pin)	0.07	0.07	0.07	0.20

# Air Cylinder: Standard Type **CM2 Series**

## Single Acting, Spring Return/Extend

### Built-in One-touch Fittings (The shape is the same as the current product.)

CM2
Mounting type
Bore size
F
Stroke
Action

↓ Built-in One-touch fittings

This type has the One-touch fitting integrated in a cylinder, which enables to reduce the piping labor and installing space dramatically.



### Specifications

Action	Single acting, Spring return	Single acting, Spring extend
Bore size (mm)	φ20, φ25, φ32, φ40	
Max. operating pressure	1.0 MPa	
Min. operating pressure	0.18 MPa	0.23 MPa
Cushion	Rubber bumper	
Piping	One-touch fittings	
Piston speed	50 to 750 mm/s	
Mounting	Basic, Axial foot, Rod flange, Head flange, Single clevis, Double clevis, Rod trunnion, Head trunnion, Integrated clevis, Boss-cut	

\* Auto switch can be mounted.

### Applicable Tubing O.D./I.D.

Bore size (mm)	20	25	32	40
Applicable tubing O.D./I.D. (mm)	6/4	6/4	6/4	8/6
Applicable tubing material	Can be used for either nylon, soft nylon or polyurethane tubing.			

### ⚠ Caution

1. One-touch fitting cannot be replaced.
  - One-touch fitting is press-fit into the cover, thus cannot be replaced.
2. Refer to Fittings and Tubing Precautions (Best Pneumatics No. 7) for handling One-touch fittings.

**CJ1**

**CJP**

**CJ2**

**JCM**

**CM2**

**CM3**

**CG1**

**CG3**

**JMB**

**MB**

**MB1**

**CA2**

**CS1**

**CS2**

**D-□**

**-X□**

Technical  
Data

# CM2 Series

## Construction

### Spring return

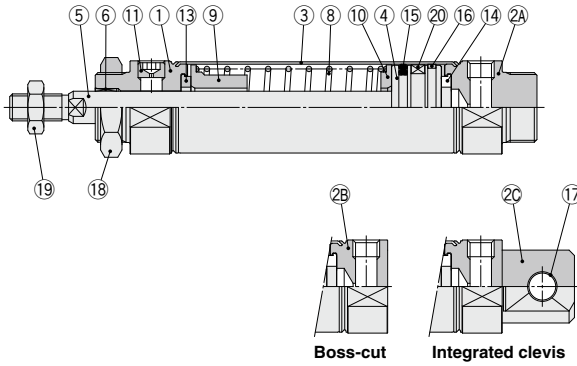

### Spring extend

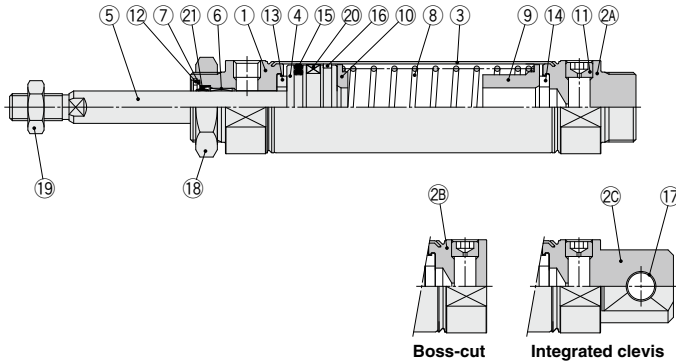

### Component Parts

No.	Description	Material	Note
1	Rod cover	Aluminum alloy	Anodized
2A	Head cover A	Aluminum alloy	Anodized
2B	Head cover B	Aluminum alloy	Anodized
2C	Head cover C	Aluminum alloy	Anodized
3	Cylinder tube	Stainless steel	
4	Piston	Aluminum alloy	
5	Piston rod	Carbon steel	Hard chrome plating
6	Bushing	Bearing alloy	
7	Seal retainer	Stainless steel	
8	Return spring	Steel wire	Zinc chromated
9	Spring guide	Aluminum alloy	Chromated
10	Spring seat	Aluminum alloy	Chromated
11	Plug with fixed orifice	Alloy steel	Black zinc chromated
12	Retaining ring	Carbon steel	Phosphate coating

No.	Description	Material	Note
13	Bumper	Resin	ø25 or larger is common.
14	Bumper	Resin	
15	Piston seal	NBR	
16	Wear ring	Resin	
17	Clevis bushing	Bearing alloy	
18	Mounting nut	Carbon steel	Nickel plating
19	Rod end nut	Carbon steel	Zinc chromated
20	Magnet	—	CDM2□20 to 40-□ $\frac{S}{Z}$
21	Rod seal	NBR	

### Replacement Part: Seal

#### ● With Rubber Bumper (Spring extend only)

No.	Description	Material	Part no.			
			20	25	32	40
21	Rod seal	NBR	CM20Z-PS	CM25Z-PS	CM32Z-PS	CM40Z-PS

\* Since the seal does not include a grease pack, order it separately.

Grease pack part number: GR-S-010 (10 g)

**Basic (Double-side Bossed) (B)**

CM2B Bore size — Stroke  $\frac{S}{Z}$   
Spring return

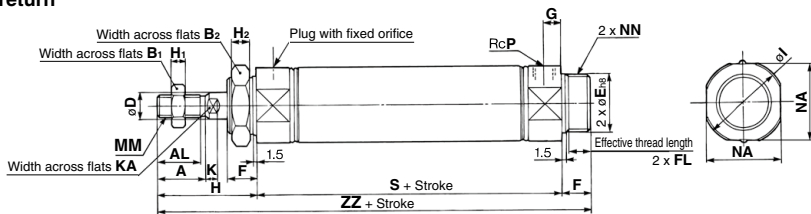

**Spring extend**

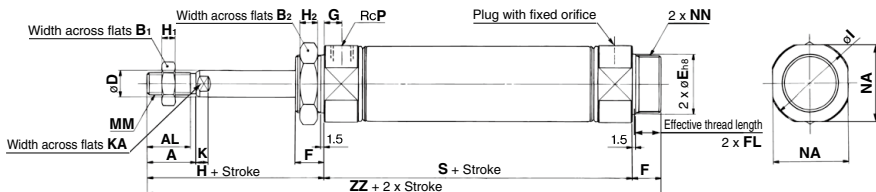

**Boss-cut**

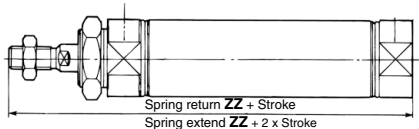

**Female rod end  
Spring return**

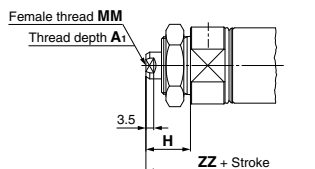

**Spring extend**

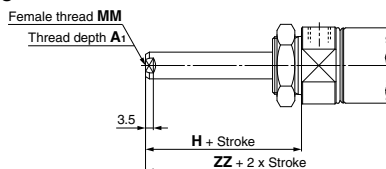

Bore size	A	AL	B <sub>1</sub>	B <sub>2</sub>	D	E	F	FL	G	H	H <sub>1</sub>	H <sub>2</sub>	I	K	KA	MM	NA	NN	P
20	18	15.5	13	26	8	20 <sup>0</sup> <sub>0.033</sub>	13	10.5	8	41	5	8	28	5	6	M8 x 1.25	24	M20 x 1.5	1/8
25	22	19.5	17	32	10	26 <sup>0</sup> <sub>0.033</sub>	13	10.5	8	45	6	8	33.5	5.5	8	M10 x 1.25	30	M26 x 1.5	1/8
32	22	19.5	17	32	12	26 <sup>0</sup> <sub>0.033</sub>	13	10.5	8	45	6	8	37.5	5.5	10	M10 x 1.25	34.5	M26 x 1.5	1/8
40	24	21	22	41	14	32 <sup>0</sup> <sub>0.033</sub>	16	13.5	11	50	8	10	46.5	7	12	M14 x 1.5	42.5	M32 x 2	1/4

**Dimensions by Stroke**

Stroke Symbol	1 to 50		51 to 100		101 to 150		151 to 200		201 to 250	
	S	ZZ	S	ZZ	S	ZZ	S	ZZ	S	ZZ
20	87	141	112	166	137	191	—	—	—	—
25	87	145	112	170	137	195	—	—	—	—
32	89	147	114	172	139	197	164	222	—	—
40	113	179	138	204	163	229	188	254	213	279

**Boss-cut**

Stroke Symbol	1 to 50		51 to 100		101 to 150		151 to 200		201 to 250	
	ZZ	ZZ	ZZ	ZZ	ZZ	ZZ	ZZ	ZZ	ZZ	ZZ
20	128	153	178	—	—	—	—	—	—	—
25	132	157	182	—	—	—	—	—	—	—
32	134	159	184	209	—	—	—	—	—	—
40	163	188	213	238	263	—	—	—	—	—

**Female Rod End**

Stroke Symbol	1 to 50		51 to 100		101 to 150		151 to 200		201 to 250		
	A <sub>1</sub>	H	S	ZZ	S	ZZ	S	ZZ	S	ZZ	
20	8	20	M4 x 0.7	87	120	112	145	137	170	—	—
25	8	20	M5 x 0.8	87	120	112	145	137	170	—	—
32	12	20	M6 x 1	89	122	114	147	139	172	164	197
40	13	21	M8 x 1.25	113	150	138	175	163	200	188	225

\* When female thread is used, use a thin wrench when tightening the piston rod.  
\* When female thread is used, use a washer etc. to prevent the contact part at the rod end from being deformed depending on the material of the workpiece.

- CJ1
- CJP
- CJ2
- JCM
- CM2
- CM3
- CG1
- CG3
- JMB
- MB
- MB1
- CA2
- CS1
- CS2

# CM2 Series

## Axial Foot (L)

CM2L **Bore size** – **Stroke**  $\frac{S}{Z}$

### Spring return

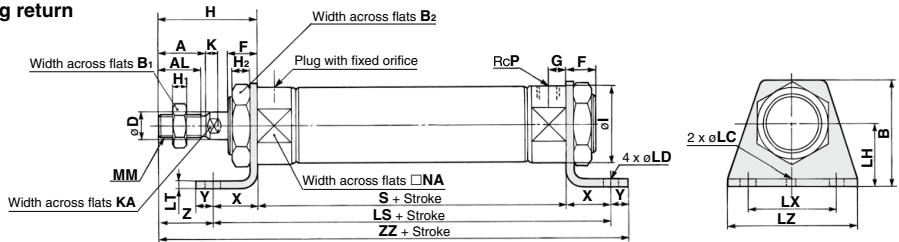

### Spring extend

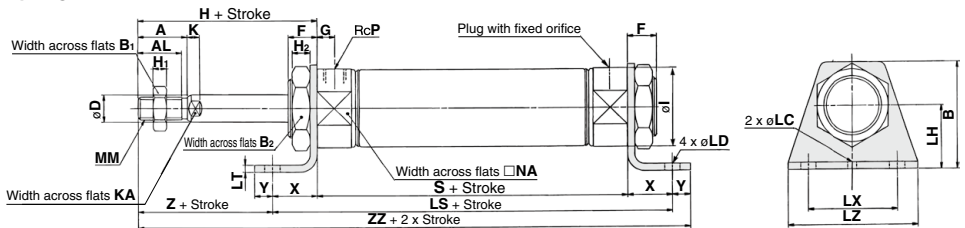

Bore size	A	AL	B	B <sub>1</sub>	B <sub>2</sub>	D	F	G	H	H <sub>1</sub>	H <sub>2</sub>	I	K	KA	LC	LD	LH	LT	LX	LZ	MM	NA	P	X	Y	Z
20	18	15.5	40	13	26	8	13	8	41	5	8	28	5	6	4	6.8	25	3.2	40	55	M8 x 1.25	24	1/8	20	8	21
25	22	19.5	47	17	32	10	13	8	45	6	8	33.5	5.5	8	4	6.8	28	3.2	40	55	M10 x 1.25	30	1/8	20	8	25
32	22	19.5	47	17	32	12	13	8	45	6	8	37.5	5.5	10	4	6.8	28	3.2	40	55	M10 x 1.25	34.5	1/8	20	8	25
40	24	21	54	22	41	14	16	11	50	8	10	46.5	7	12	4	7	30	3.2	55	75	M14 x 1.5	42.5	1/4	23	10	27

### Dimensions by Stroke

Bore size	Stroke		1 to 50			51 to 100			101 to 150			151 to 200			201 to 250		
	LS	S	ZZ	LS	S	ZZ	LS	S	ZZ	LS	S	ZZ	LS	S	ZZ		
20	127	87	156	152	112	181	177	137	206	—	—	—	—	—	—		
25	127	87	160	152	112	185	177	137	210	—	—	—	—	—	—		
32	129	89	162	154	114	187	179	139	212	204	164	237	—	—	—		
40	159	113	196	184	138	221	209	163	246	234	188	271	259	213	296		

\* The bracket is shipped together.

\* Refer to page 209 for female thread dimensions.



## Rod Flange (F)

CM2F Bore size — Stroke  $\begin{matrix} S \\ | \\ Z \end{matrix}$

### Spring return

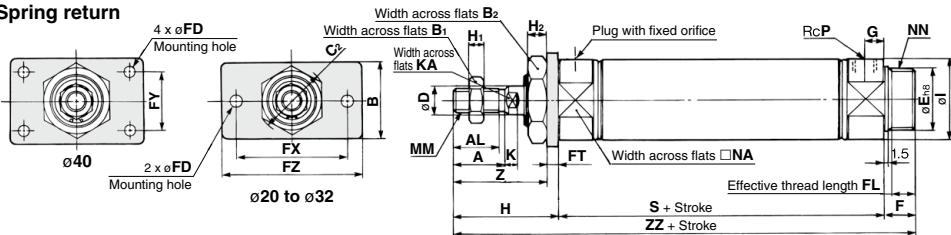

### Spring extend

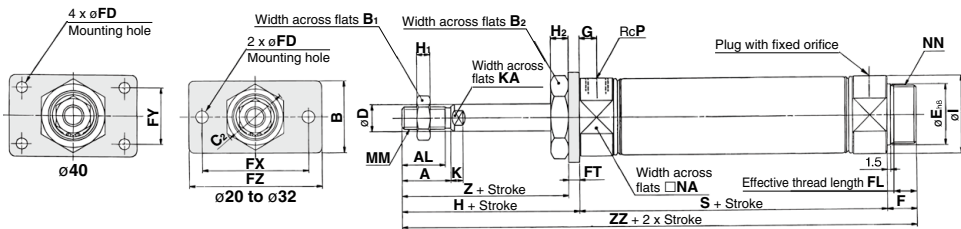

### Boss-cut

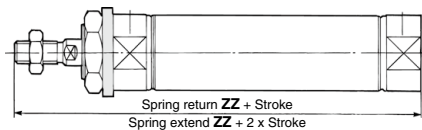

Bore size	A	AL	B	B <sub>1</sub>	B <sub>2</sub>	C <sub>2</sub>	D	E	F	FD	FL	FT	FX	FY	FZ	G	H	H <sub>1</sub>	H <sub>2</sub>	I	K	KA	MM	NA	NN	P	Z
20	18	15.5	34	13	26	30	8	20 <sup>0</sup> <sub>-0.033</sub>	13	7	10.5	4	60	—	75	8	41	5	8	28	5	6	M8 x 1.25	24	M20 x 1.5	1/8	37
25	22	19.5	40	17	32	37	10	26 <sup>0</sup> <sub>-0.033</sub>	13	7	10.5	4	60	—	75	8	45	6	8	33.5	5.5	8	M10 x 1.25	30	M26 x 1.5	1/8	41
32	22	19.5	40	17	32	37	12	26 <sup>0</sup> <sub>-0.033</sub>	13	7	10.5	4	60	—	75	8	45	6	8	37.5	5.5	10	M10 x 1.25	34.5	M26 x 1.5	1/8	41
40	24	21	52	22	41	47.3	14	32 <sup>0</sup> <sub>-0.039</sub>	16	7	13.5	5	66	36	82	11	50	8	10	46.5	7	12	M14 x 1.5	42.5	M32 x 2	1/4	45

Bore size	Stroke (mm)									
	1 to 50		51 to 100		101 to 150		151 to 200		201 to 250	
Symbol	S	ZZ	S	ZZ	S	ZZ	S	ZZ	S	ZZ
20	87	141	112	166	137	191	—	—	—	—
25	87	145	112	170	137	195	—	—	—	—
32	89	147	114	172	139	197	164	222	—	—
40	113	179	138	204	163	229	188	254	213	279

Bore size	Boss-cut (mm)				
	1 to 50	51 to 100	101 to 150	151 to 200	201 to 250
Symbol	ZZ	ZZ	ZZ	ZZ	ZZ
20	128	153	178	—	—
25	132	157	182	—	—
32	134	159	184	209	—
40	163	188	213	238	263

\* The bracket is shipped together.  
\* Refer to page 209 for female thread dimensions.

- CG1
- CGP
- CJ2
- JCM
- CM2**
- CM3
- CG1
- CG3
- JMB
- MB
- MB1
- CA2
- CS1
- CS2

- D-□
- X□
- Technical Data

# CM2 Series

## Head Flange (G)

CM2G **Bore size** – **Stroke**  $\frac{S}{Z}$

### Spring return

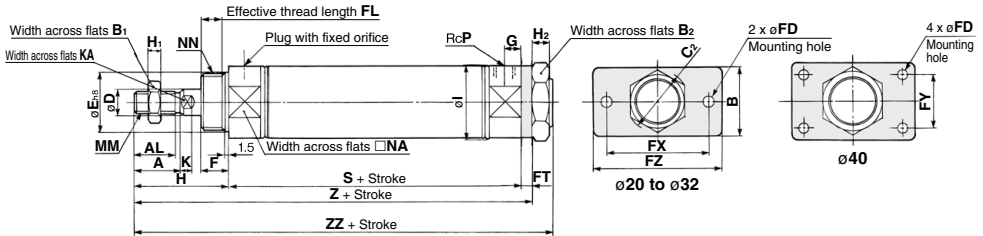

### Spring extend

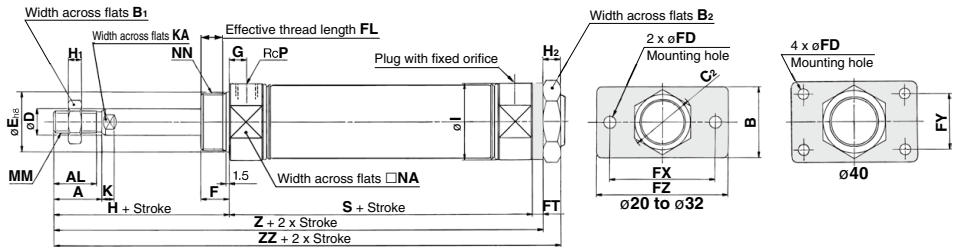

Bore size	A	AL	B	B <sub>1</sub>	B <sub>2</sub>	C <sub>2</sub>	D	E	F	FD	FL	FT	FX	FY	FZ	G	H	H <sub>1</sub>	H <sub>2</sub>	I	K	KA	MM	NA	NN	P
20	18	15.5	34	13	26	30	8	20 <sup>0</sup> <sub>-0.033</sub>	13	7	10.5	4	60	—	75	8	41	5	8	28	5	6	M8 x 1.25	24	M20 x 1.5	1/8
25	22	19.5	40	17	32	37	10	26 <sup>0</sup> <sub>-0.033</sub>	13	7	10.5	4	60	—	75	8	45	6	8	33.5	5.5	8	M10 x 1.25	30	M26 x 1.5	1/8
32	22	19.5	40	17	32	37	12	26 <sup>0</sup> <sub>-0.033</sub>	13	7	10.5	4	60	—	75	8	45	6	8	37.5	5.5	10	M10 x 1.25	34.5	M26 x 1.5	1/8
40	24	21	52	22	41	47.3	14	32 <sup>0</sup> <sub>-0.039</sub>	16	7	13.5	5	66	36	82	11	50	8	10	46.5	7	12	M14 x 1.5	42.5	M32 x 2	1/4

Bore size	Stroke														
	1 to 50			51 to 100			101 to 150			151 to 200			201 to 250		
	S	Z	ZZ	S	Z	ZZ	S	Z	ZZ	S	Z	ZZ	S	Z	ZZ
20	87	132	141	112	157	166	137	182	191	—	—	—	—	—	—
25	87	136	145	112	161	170	137	186	195	—	—	—	—	—	—
32	89	138	147	114	163	172	139	188	197	164	213	222	—	—	—
40	113	168	179	138	193	204	163	218	229	188	243	254	213	268	279

\* The bracket is shipped together.

\* Refer to page 209 for female thread dimensions.

### Single Clevis (C)

CM2C Bore size - Stroke  $\begin{matrix} S \\ Z \\ ZZ \end{matrix}$

#### Spring return

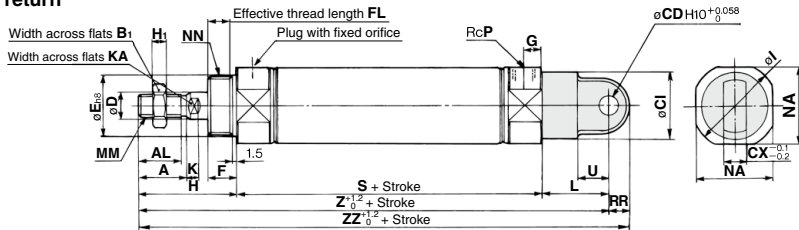

#### Spring extend

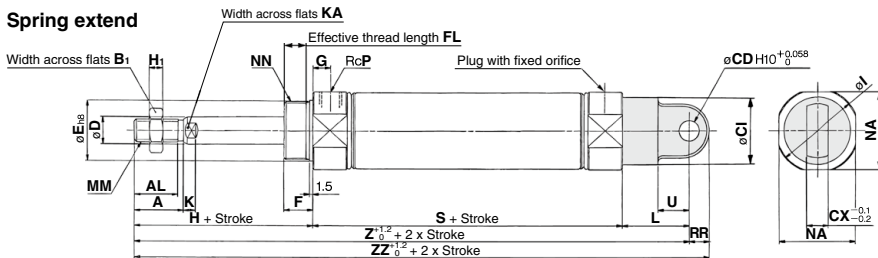

- CJ1
- CJP
- CJ2
- JCM
- CM2**
- CM3
- CG1
- CG3
- JMB
- MB
- MB1
- CA2
- CS1
- CS2

Bore size	A	AL	B <sub>1</sub>	CD	CI	CX	D	E	F	FL	G	H	H <sub>1</sub>	I	K	KA	L	MM	NA	NN	P	RR	U
20	18	15.5	13	9	24	10	8	20 <sup>0</sup> <sub>-0.033</sub>	13	10.5	8	41	5	28	5	6	30	M8 x 1.25	24	M20 x 1.5	1/8	9	14
25	22	19.5	17	9	30	10	10	26 <sup>0</sup> <sub>-0.033</sub>	13	10.5	8	45	6	33.5	5.5	8	30	M10 x 1.25	30	M26 x 1.5	1/8	9	14
32	22	19.5	17	9	30	10	12	26 <sup>0</sup> <sub>-0.033</sub>	13	10.5	8	45	6	37.5	5.5	10	30	M10 x 1.25	34.5	M26 x 1.5	1/8	9	14
40	24	21	22	10	38	15	14	32 <sup>0</sup> <sub>-0.039</sub>	16	13.5	11	50	8	46.5	7	12	39	M14 x 1.5	42.5	M32 x 2	1/4	11	18

#### Dimensions by Stroke

Bore size	1 to 50		51 to 100			101 to 150			151 to 200			201 to 250			
	S	Z	ZZ	S	Z	ZZ	S	Z	ZZ	S	Z	ZZ	S	Z	ZZ
20	87	158	167	112	183	192	137	208	217	—	—	—	—	—	—
25	87	162	171	112	187	196	137	212	221	—	—	—	—	—	—
32	89	164	173	114	189	198	139	214	223	164	239	248	—	—	—
40	113	202	213	138	227	238	163	252	263	188	277	288	213	302	313

\* Refer to page 209 for female thread dimensions.

- D-□
- X□
- Technical Data

# CM2 Series

## Double Clevis (D)

CM2D Bore size – Stroke | S Z

### Spring return

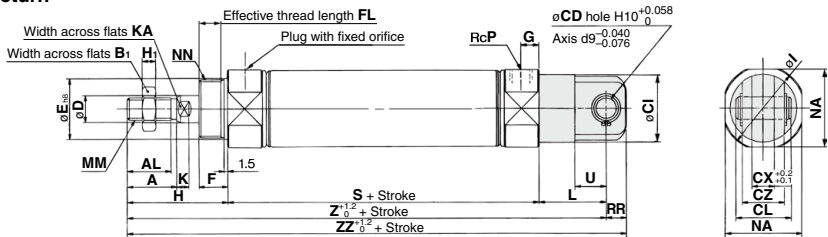

### Spring extend

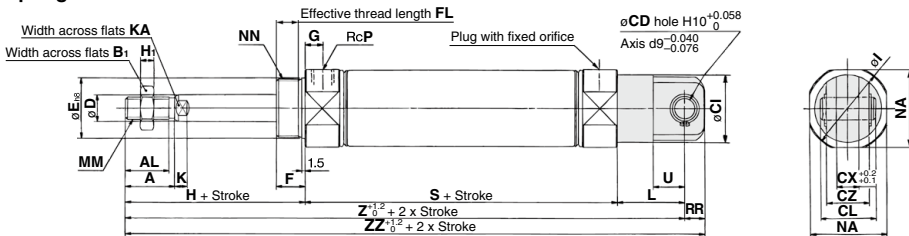

Bore size	A	AL	B <sub>1</sub>	CD	CI	CL	CX	CZ	D	E	F	FL	G	H	H <sub>1</sub>	I	K	KA	L	MM	NA	NN	P	RR	U
20	18	15.5	13	9	24	25	10	19	8	20 <sup>0</sup> <sub>-0.033</sub>	13	10.5	8	41	5	28	5	6	30	M8 x 1.25	24	M20 x 1.5	1/8	9	14
25	22	19.5	17	9	30	25	10	19	10	26 <sup>0</sup> <sub>-0.033</sub>	13	10.5	8	45	6	33.5	5.5	8	30	M10 x 1.25	30	M26 x 1.5	1/8	9	14
32	22	19.5	17	9	30	25	10	19	12	26 <sup>0</sup> <sub>-0.033</sub>	13	10.5	8	45	6	37.5	5.5	10	30	M10 x 1.25	34.5	M26 x 1.5	1/8	9	14
40	24	21	22	10	38	41.2	15	30	14	32 <sup>0</sup> <sub>-0.039</sub>	16	13.5	11	50	8	46.5	7	12	39	M14 x 1.5	42.5	M32 x 2	1/4	11	18

### Dimensions by Stroke

Bore size	Stroke		1 to 50			51 to 100			101 to 150			151 to 200			201 to 250		
	S	Z	S	Z	ZZ	S	Z	ZZ	S	Z	ZZ	S	Z	ZZ	S	Z	ZZ
20	87	158	167	112	183	192	137	208	217	—	—	—	—	—	—	—	—
25	87	162	171	112	187	196	137	212	221	—	—	—	—	—	—	—	—
32	89	164	173	114	189	198	139	214	223	164	239	248	—	—	—	—	—
40	113	202	213	138	227	238	163	252	263	188	277	288	213	302	313	—	—

\* Refer to page 209 for female thread dimensions.

## Rod Trunnion (U)

CM2U Bore size - Stroke S Z

### Spring return

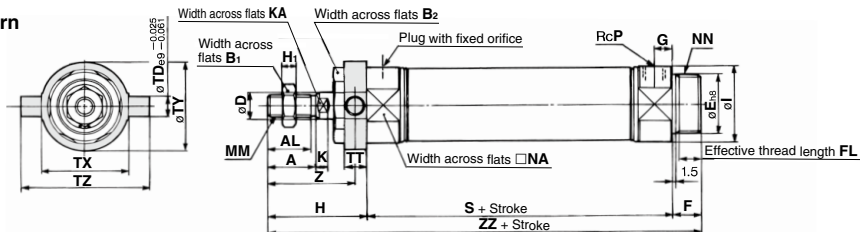

### Spring extend

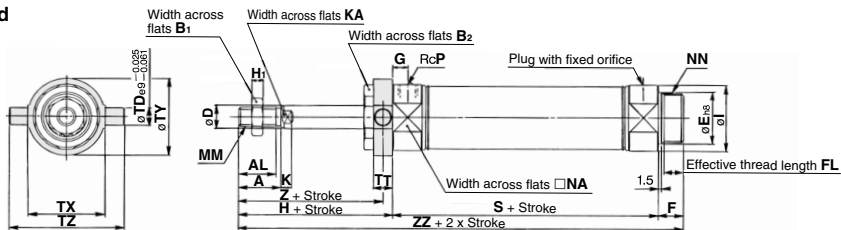

### Boss-cut

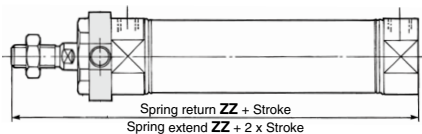

Bore size	A	AL	B <sub>1</sub>	B <sub>2</sub>	D	E	F	FL	G	H	H <sub>1</sub>	I	K	KA	MM	NA	NN	P	TD	TT	TX	TY	TZ	Z
20	18	15.5	13	26	8	20 <sup>+0.033</sup>	13	10.5	8	41	5	28	5	6	M8 x 1.25	24	M20 x 1.5	1/8	8	10	32	32	52	36
25	22	19.5	17	32	10	26 <sup>+0.033</sup>	13	10.5	8	45	6	33.5	5.5	8	M10 x 1.25	30	M26 x 1.5	1/8	9	10	40	40	60	40
32	22	19.5	17	32	12	26 <sup>+0.033</sup>	13	10.5	8	45	6	37.5	5.5	10	M10 x 1.25	34.5	M26 x 1.5	1/8	9	10	40	40	60	40
40	24	21	22	41	14	32 <sup>+0.039</sup>	16	13.5	11	50	8	46.5	7	12	M14 x 1.5	42.5	M32 x 2	1/4	10	11	53	53	77	44.5

### Dimensions by Stroke

Bore size	Stroke		Stroke		Stroke		Stroke		Stroke	
	S	ZZ	S	ZZ	S	ZZ	S	ZZ	S	ZZ
20	87	141	112	166	137	191	—	—	—	—
25	87	145	112	170	137	195	—	—	—	—
32	89	147	114	172	139	197	164	222	—	—
40	113	179	138	204	163	229	188	254	213	279

### Boss-cut

Bore size	Stroke		Stroke		Stroke	
	ZZ	ZZ	ZZ	ZZ	ZZ	ZZ
20	128	153	178	—	—	—
25	132	157	182	—	—	—
32	134	159	184	209	—	—
40	163	188	213	238	263	—

\* The bracket is shipped together.  
\* Refer to page 209 for female thread dimensions.

- CJ1
- CJP
- CJ2
- JCM
- CM2**
- CM3
- CG1
- CG3
- JMB
- MB
- MB1
- CA2
- CS1
- CS2

- D-□
- X□
- Technical Data

# CM2 Series

## Head Trunnion (T)

CM2T Bore size – Stroke  $\frac{S}{T}$  Z

### Spring return

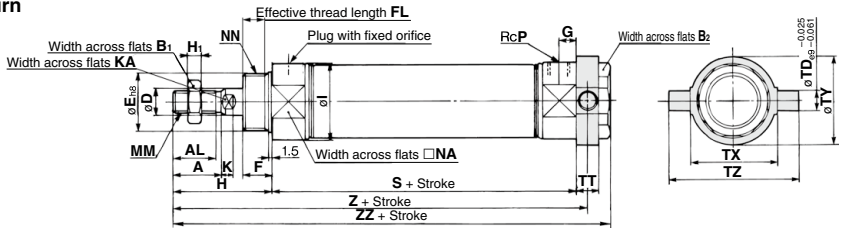

### Spring extend

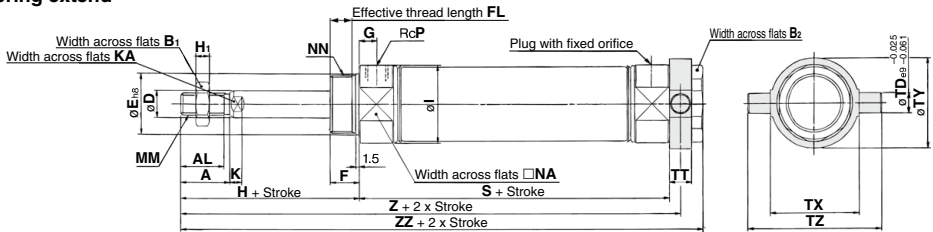

Bore size	A	AL	B <sub>1</sub>	B <sub>2</sub>	D	E	F	FL	G	H	H <sub>1</sub>	I	K	KA	MM	NA	NN	P	TD	TT	TX	TY	TZ
20	18	15.5	13	26	8	20 <sup>+0.033</sup>	13	10.5	8	41	5	28	5	6	M8 x 1.25	24	M20 x 1.5	1/8	8	10	32	32	52
25	22	19.5	17	32	10	26 <sup>+0.033</sup>	13	10.5	8	45	6	33.5	5.5	8	M10 x 1.25	30	M26 x 1.5	1/8	9	10	40	40	60
32	22	19.5	17	32	12	26 <sup>+0.033</sup>	13	10.5	8	45	6	37.5	5.5	10	M10 x 1.25	34.5	M26 x 1.5	1/8	9	10	40	40	60
40	24	21	22	41	14	32 <sup>+0.039</sup>	16	13.5	11	50	8	46.5	7	12	M14 x 1.5	42.5	M32 x 2	1/4	10	11	53	53	77

Stroke		1 to 50			51 to 100			101 to 150			151 to 200			201 to 250		
Bore size	Symbol	S	Z	ZZ	S	Z	ZZ	S	Z	ZZ	S	Z	ZZ	S	Z	ZZ
20		87	133	143	112	158	168	137	183	193	—	—	—	—	—	—
25		87	137	147	112	162	172	137	187	197	—	—	—	—	—	—
32		89	139	149	114	164	174	139	189	199	164	214	224	—	—	—
40		113	168.5	179	138	193.5	204	163	218.5	229	188	243.5	254	213	268.5	279

\* The bracket is shipped together.  
\* Refer to page 209 for female thread dimensions.

## Integrated Clevis (E)

CM2E Bore size – Stroke  $\frac{S}{T}$  Z

### Spring return

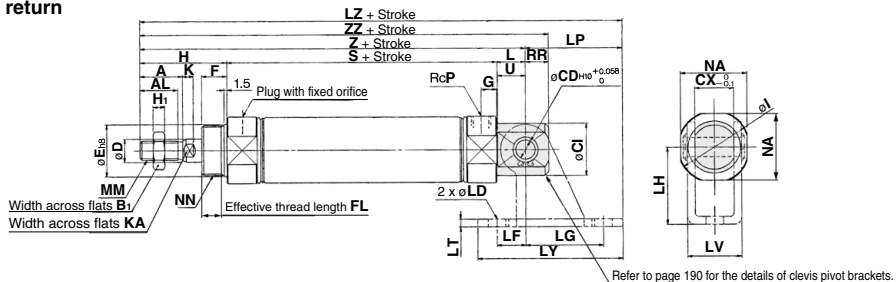

### Spring extend

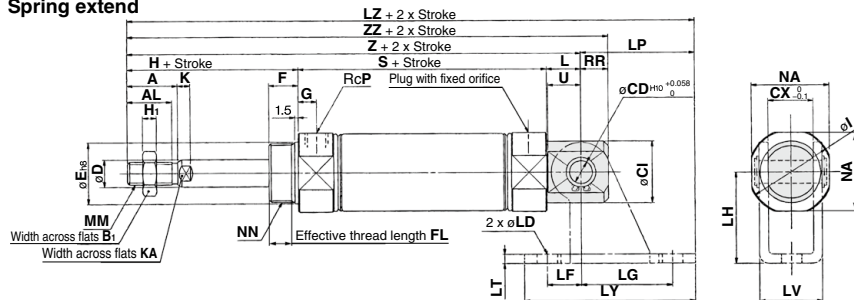

Bore size	(mm)																						
	A	AL	B <sub>1</sub>	CD	CI	CX	D	E	F	FL	G	H	H <sub>1</sub>	I	K	KA	L	MM	NA	NN	P	RR	U
20	18	15.5	13	8	20	12	8	20 <sup>0</sup> <sub>-0.033</sub>	13	10.5	8	41	5	28	5	6	12	M8 x 1.25	24	M20 x 1.5	1/8	9	11.5
25	22	19.5	17	8	22	12	10	26 <sup>0</sup> <sub>-0.033</sub>	13	10.5	8	45	6	33.5	5.5	8	12	M10 x 1.25	30	M26 x 1.5	1/8	9	11.5
32	22	19.5	17	10	27	20	12	26 <sup>0</sup> <sub>-0.033</sub>	13	10.5	8	45	6	37.5	5.5	10	15	M10 x 1.25	34.5	M26 x 1.5	1/8	12	14.5
40	24	21	22	10	33	20	14	32 <sup>0</sup> <sub>-0.039</sub>	16	13.5	11	50	8	46.5	7	12	15	M14 x 1.5	42.5	M32 x 2	1/4	12	14.5

### Dimensions by Stroke

Bore size	(mm)																	
	Stroke			1 to 50			51 to 100			101 to 150			151 to 200			201 to 250		
Symbol	S	Z	ZZ	S	Z	ZZ	S	Z	ZZ	S	Z	ZZ	S	Z	ZZ	S	Z	ZZ
20	87	140	149	112	165	174	137	190	199	—	—	—	—	—	—	—	—	—
25	87	144	153	112	169	178	137	194	203	—	—	—	—	—	—	—	—	—
32	89	149	161	114	174	186	139	199	211	164	224	236	—	—	—	—	—	—
40	113	178	190	138	203	215	163	228	240	188	253	265	213	278	290	—	—	—

### Clevis Pivot Bracket

Bore size	(mm)														
	LD	LF	LG	LH	LP	LT	LV	LY	1 to 50	51 to 100	101 to 150	151 to 200	201 to 250		
	LZ	LZ	LZ	LZ	LZ			LZ	LZ	LZ	LZ	LZ			
20	6.8	15	30	30	37	3.2	18.4	59	177	202	227	—	—		
25	6.8	15	30	30	37	3.2	18.4	59	181	206	231	—	—		
32	9	15	40	40	50	4	28	75	199	224	249	274	—		
40	9	15	40	40	50	4	28	75	228	253	278	303	328		

• Refer to page 209 for female thread dimensions.

- CJ1
- CJP
- CJ2
- JCM
- CM2
- CM3
- CG1
- CG3
- JMB
- MB
- MB1
- CA2
- CS1
- CS2

D-□

-X□

Technical Data

# Air Cylinder: Non-rotating Rod Type

## Double Acting, Single Rod

# CM2K Series

ø20, ø25, ø32, ø40



### How to Order

B	Basic (Double-side bossed)
L	Axial foot
F	Rod flange
G	Head flange
C	Single clevis
D	Double clevis
U	Rod trunnion

T	Head trunnion
E	Integrated clevis
V	Integrated clevis (90°)
BZ	Boss-cut/Basic
FZ	Boss-cut/Rod flange
UZ	Boss-cut/Rod trunnion

Bore size	
20	20 mm
25	25 mm
32	32 mm
40	40 mm

**Cylinder stroke (mm)**  
Refer to "Standard Strokes" on page 219.

Cushion	
Nil	Rubber bumper
A	Air cushion

Pivot bracket	
Nil	None
N	Pivot bracket is shipped together with the product, but not assembled.

\* Only for C, T, U, E, V, UZ mounting types.  
\* Pivot bracket is shipped together with the product, but not assembled.

**Made to Order**  
Refer to page 219 for details.

CM2K B 40 - 150 A [ ] [ ] Z - [ ] [ ] [ ] [ ]

**With auto switch**

CDM2K B 40 - 150 A [ ] [ ] Z - [ ] [ ] [ ] [ ] M9BW [ ] [ ] [ ] [ ]

**With auto switch**  
(Built-in magnet)

Rod end thread	
Nil	Male rod end
F	Female rod end

Rod boot	
Nil	None
J	Nylon tarpaulin
K	Heat resistant tarpaulin

\* For female rod end, no rod boot is provided.

Rod end bracket	
Nil	None
V	Single knuckle joint
W	Double knuckle joint

\* No bracket is provided for the female rod end.  
\* A knuckle joint pin is not provided with the single knuckle joint.  
\* Rod end bracket is shipped together with the product, but not assembled.  
\* Not applicable to XB12.

Auto switch	
Nil	Without auto switch

\* For applicable auto switches, refer to the table below.

Number of auto switches	
Nil	2 pcs.
S	1 pc.
n	"n" pcs.

\* Refer to "Ordering Example of Cylinder Assembly" on page 219.

### Applicable Auto Switches/Refer to pages 1575 to 1701 for further information on auto switches.

Type	Special function	Electrical entry	Indicator/light	Wiring (Output)	Load voltage		Auto switch model		Lead wire length (m)				Pre-wired connector	Applicable load				
					DC	AC	Perpendicular	In-line	0.5	1	3	5			None (N)			
									(Nil)	(M)	(L)	(Z)						
Solid state auto switch	—	Grommet	No	3-wire (NPN)	5 V, 12 V	—	M9NV	M9N	●	●	●	●	—	—	IC circuit			
				3-wire (PNP)			M9PV	M9P	●	●	●	●	—	—				
		Connector		2-wire	12 V	—	M9BV	M9B	●	●	●	●	—	—		—		
				Terminal conduit			2-wire	H7C	—	—	—	—	—	—			—	
		Diagnostic indication (2-color indicator)		Grommet	Yes	3-wire (NPN)	24 V	5 V, 12 V	—	—	G39A**	—	—	—		—	—	IC circuit
						3-wire (PNP)				—	K39A**	—	—	—		—	—	
	Water resistant (2-color indicator)	Grommet	No	3-wire (NPN)	5 V, 12 V	—	—	M9NVV	M9NV	●	●	●	●	—	—	IC circuit		
				3-wire (PNP)				M9PVV	M9PV	●	●	●	●	—	—			
	With diagnostic output (2-color indicator)	Grommet	Yes	2-wire	12 V	—	—	M9NAV*1	M9NA*1	○	○	○	○	—	—	IC circuit		
				3-wire (NPN)				M9PAV*1	M9PA*1	○	○	○	○	—	—			
Reed auto switch	—	Grommet	No/Yes/No	3-wire (NPN equivalent)	24 V	12 V	—	M96V	A96	●	—	—	—	—	IC circuit			
				Connector				100 V	A93V*2	A93	●	●	●	—		—	—	
								100 V or less	A90V	A90	●	—	—	—		—	—	
								100 V, 200 V	—	B54**	●	—	—	—		—	—	
								200 V or less	—	B64**	●	—	—	—		—	—	
		Terminal conduit		24 V or less	—	C73C	●	—	—	—	—	—	—	—	IC circuit			
				24 V or less	—	C80C	●	—	—	—	—	—	—	—				
				—	—	A33A**	—	—	—	—	—	—	—	PLC				
				100 V, 200 V	—	A34A**	—	—	—	—	—	—	—					
				—	—	A44A**	—	—	—	—	—	—						
Diagnostic indication (2-color indicator)	Grommet	Yes	—	—	—	—	B59W	●	—	—	—	—	IC circuit					

\*1 Water resistant type auto switches can be mounted on the above models, but in such case SMC cannot guarantee water resistance.  
 \*2 Please contact SMC regarding water resistant types with the above model numbers.  
 \*3 1 m type lead wire is only applicable to D-A93.  
 \*4 Lead wire length symbols: 0.5 m ..... Nil (Example) M9NV  
 1 m ..... M (Example) M9NVW  
 3 m ..... L (Example) M9NWL  
 5 m ..... Z (Example) M9NVZ  
 None ..... N (Example) H7CN  
 \*5 Solid state auto switches marked with "○" are produced upon receipt of order.  
 \*6 Do not indicate suffix "N" for no lead wire on the D-A3□/A44A/G39A/K39A models.  
 \*7 D-A3□/A44A/G39A/K39A/B54/B64 cannot be mounted on bore sizes ø20 and ø25 cylinder with air cushion.  
 \*8 Since there are other applicable auto switches than listed above, refer to page 266 for details.  
 \*9 For details about auto switches with pre-wired connector, refer to pages 1648 and 1649.  
 \*10 The D-A9□/M9□□□ auto switches are shipped together, (but not assembled). (However, only the auto switch mounting brackets are assembled before shipment.)





**A cylinder which rod does not rotate because of the hexagonal rod shape.**

**Non-rotating accuracy**

∅20, ∅25 —±0.7°

∅32, ∅40 —±0.5°

**Can operate without lubrication.**

**The same installation dimensions as the standard cylinder.**

**Auto switches can also be mounted.**

It can be installed with auto switches to simplify the detection of the stroke position of the cylinder.

**Symbol**

Rubber bumper

Air cushion

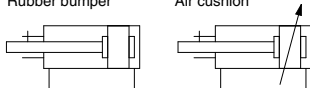

**Made to Order: Individual Specifications**  
(For details, refer to page 267.)

Symbol	Specifications
-X446	PTFE grease

**Made to Order**

[Click here for details](#)

Symbol	Specifications
-XA□	Change of rod end shape
-XB6	Heat resistant cylinder (-10 to 150°C)
-XB12	External stainless steel cylinder*2
-XC3	Special port location
-XC6	Made of stainless steel
-XC8	Adjustable stroke cylinder/Adjustable extension type
-XC9	Adjustable stroke cylinder/Adjustable retraction type*1
-XC10	Dual stroke cylinder/Double rod type*1
-XC11	Dual stroke cylinder/Single rod type*1
-XC13	Auto switch rail mounting
-XC20	Head cover axial port
-XC22	Fluororubber seal
-XC25	No fixed throttle of connection port*1
-XC27	Double clevis and double knuckle pins made of stainless steel
-XC52	Mounting nut with set screw
-XC85	Grease for food processing equipment

\*1 Rubber bumper only.

\*2 The shape is the same as the current product.

Refer to pages 262 to 266 for cylinders with auto switches.

- Auto switch proper mounting position (detection at stroke end) and its mounting height
- Minimum stroke for auto switch mounting
- Operating range
- Auto switch mounting brackets/Part no.

## Specifications

Bore size (mm)		20	25	32	40	
Rod non-rotating accuracy		±0.7°		±0.5°		
Type	Pneumatic					
Action	Double acting, Single rod					
Fluid	Air					
Proof pressure	1.5 MPa					
Maximum operating pressure	1.0 MPa					
Minimum operating pressure	0.05 MPa					
Ambient and fluid temperature	Without auto switch: -10°C to 70°C With auto switch: -10°C to 60°C (No freezing)					
Lubrication	Not required (Non-lube)					
Stroke length tolerance	+1.4 0 mm					
Piston speed	50 to 500 mm/s					
Cushion	Rubber bumper, Air cushion					
Allowable kinetic energy	Rubber bumper	Male thread	0.27 J	0.4 J	0.65 J	1.2 J
		Female thread	0.11 J	0.18 J	0.29 J	0.52 J
	Air cushion (Effective cushion length (mm))	Male thread	0.54 J (11.0)	0.78 J (11.0)	1.27 J (11.0)	2.35 J (11.8)
		Female thread	0.11 J	0.18 J	0.29 J	0.52 J

## Standard Strokes

Bore size (mm)	Standard stroke (mm) Note 1)	Maximum manufacturable stroke (mm)
20	25, 50, 75, 100, 125, 150, 200, 250, 300	1000
25		
32		
40		

Note 1) Intermediate strokes not listed above are produced upon receipt of order.

Manufacture of intermediate strokes in 1 mm increments is possible. (Spacers are not used.)

Note 2) Applicable strokes should be confirmed according to the usage. For details, refer to "Air Cylinders Model Selection" on front matter pages. In addition, the products that exceed the standard stroke might not be able to fulfill the specifications due to the deflection etc.

## Rod Boot Material

Symbol	Rod boot material	Maximum ambient temperature
J	Nylon tarpaulin	60°C
K	Heat resistant tarpaulin	110°C*1

\*1 Maximum ambient temperature for the rod boot itself.

## Option: Ordering Example of Cylinder Assembly

**Cylinder model: CDM2K40-150Z-NV-M9BW**

**Mounting C: Single clevis**  
**Pivot bracket N: Yes**  
**Rod end bracket V: Single knuckle joint**  
**Auto switch D-M9BW: 2 pcs.**

\* Pivot bracket, single knuckle joint and auto switch are shipped together with the product, but not assembled.

\* Pivot bracket is available only for C, T, U, E, V, UZ mounting types.  
 \* No bracket is provided for the female rod end.

## Mounting and Accessories

Accessories	Body	Standard (mounted to the body)					Standard (packaged together, but not assembled)							Option				
		Mounting nut <small>Note 1)</small>	Rod end nut <small>(Male thread)</small>	Single clevis	Double clevis <small>Note 7)</small>	Liner	Mounting nut	Foot	Flange	Pivot bracket <small>Note 5)</small>	Pivot bracket pin <small>Note 5)</small>	Double clevis pin <small>Note 5)</small>	Trunnion	Mounting nut <small>(For trunnion)</small>	Clevis pivot bracket <small>(CM2E/CM2V)</small>	Clevis pivot bracket pin <small>(CM2E/CM2V)</small>	Single knuckle joint <small>(Male thread only)</small>	Double knuckle joint <small>(Male thread only)</small>
<b>B</b> Basic (Double-side bossed)	●(1 pc.)	●(1 pc.)	●(1 pc.)	—	—	—	—	—	—	—	—	—	—	—	—	—	●	●
<b>L</b> Axial foot	●(1 pc.)	●(1 pc.) <sup>Note 2)</sup>	●(1 pc.)	—	—	—	●(1 pc.) <sup>Note 1)</sup>	●(2 pcs.)	—	—	—	—	—	—	—	—	—	●
<b>F</b> Rod flange	●(1 pc.)	●(1 pc.)	●(1 pc.)	—	—	—	—	—	—	—	—	—	—	—	—	—	—	●
<b>G</b> Head flange	●(1 pc.)	●(1 pc.)	●(1 pc.)	—	—	—	—	—	—	—	—	—	—	—	—	—	—	●
<b>C</b> Single clevis	●(1 pc.)	— <sup>Note 3)</sup>	●(1 pc.)	●(1 pc.)	—	—	—	—	—	—	—	—	—	—	—	—	—	●
<b>D</b> Double clevis	●(1 pc.)	— <sup>Note 3)</sup>	●(1 pc.)	—	—	—	—	—	—	—	—	—	—	—	—	—	—	●
<b>U</b> Rod trunnion	●(1 pc.)	— <sup>Note 4)</sup>	●(1 pc.)	—	—	—	—	—	—	—	—	—	—	—	—	—	—	●
<b>T</b> Head trunnion	●(1 pc.)	— <sup>Note 4)</sup>	●(1 pc.)	—	—	—	—	—	—	—	—	—	—	—	—	—	—	●
<b>E</b> Integrated clevis	●(1 pc.)	— <sup>Note 3)</sup>	●(1 pc.)	—	—	—	—	—	—	—	—	—	—	—	—	—	—	●
<b>V</b> Integrated clevis (90°)	●(1 pc.)	— <sup>Note 3)</sup>	●(1 pc.)	—	—	—	—	—	—	—	—	—	—	—	—	—	—	●
<b>BZ</b> Boss-cut/Basic	●(1 pc.)	●(1 pc.)	●(1 pc.)	—	—	—	—	—	—	—	—	—	—	—	—	—	—	●
<b>FZ</b> Boss-cut/Rod flange	●(1 pc.)	●(1 pc.)	●(1 pc.)	—	—	—	—	—	—	—	—	—	—	—	—	—	—	●
<b>UZ</b> Boss-cut/Rod trunnion	●(1 pc.)	— <sup>Note 4)</sup>	●(1 pc.)	—	—	—	—	—	—	—	—	—	—	—	—	—	—	●

Note 1) Rod end nut is not provided for the female rod end.  
 Note 2) Two mounting nuts are packaged together.  
 Note 3) Mounting nut is not packaged for the clevis.  
 Note 4) Trunnion nut is packaged for U, T, UZ.  
 Note 5) Retaining rings are included.

Note 6) A pin and retaining rings (split pins for ø40) are included.  
 Note 7) This is the part(s) used to adjust the clevis angle. Mounting quantity can vary.  
 \* Stainless steel mounting brackets and accessories are also available.  
 Refer to page 190 for details.

## Mounting Brackets/Part No.

Mounting bracket	Min. order qty	Bore size (mm)			Contents (for minimum order quantity)	
		20	25	32		
Foot*	2	CM-L020B	CM-L032B		CM-L040B	2 feet, 1 mounting nut
Flange	1	CM-F020B	CM-F032B		CM-F040B	1 flange
Single clevis**	1	CM-C020B	CM-C032B		CM-C040B	1 single clevis, 3 liners
Double clevis (with pin)**	1	CM-D020B	CM-D032B		CM-D040B	1 double clevis, 3 liners, 1 clevis pin, 2 retaining rings
Double clevis pin	1	CDP-1		CDP-2	1 clevis pin, 2 retaining rings (split pins)	
Trunnion (with nut)	1	CM-T020B	CM-T032B		CM-T040B	1 trunnion, 1 trunnion nut
Rod end nut	1	NT-02	NT-03		NT-04	1 rod end nut
Mounting nut	1	SN-020B	SN-032B		SN-040B	1 mounting nut
Trunnion nut	1	TN-020B	TN-032B		TN-040B	1 trunnion nut
Single knuckle joint	1	I-020B	I-032B		I-040B	1 single knuckle joint
Double knuckle joint	1	Y-020B	Y-032B		Y-040B	1 double knuckle joint, 1 knuckle pin, 2 retaining rings
Double knuckle joint pin	1	CDP-1		CDP-3	1 knuckle pin, 2 retaining rings (split pins)	
Clevis pivot bracket pin (For CM2E/CM2V)	1	CD-S02		CD-S03	1 clevis pin, 2 retaining rings	
Clevis pivot bracket (For CM2E/CM2V)	1	CM-E020B		CM-E032B	1 clevis pivot bracket, 1 clevis pin, 2 retaining rings	
Pivot bracket (For CM2C)	1	CM-B032			CM-B040	2 pivot brackets (1 of each type)
Pivot bracket pin (For CM2C)	1	CDP-1			CD-S03	1 pin, 2 retaining rings
Pivot bracket (For CM2T/CM2U)	1	CM-B020	CM-B032		CM-B040	2 pivot brackets (1 of each type)

\* Order 2 feet per cylinder.

\*\* 3 liners are included with a clevis bracket for adjusting the mounting angle.

\*\*\* A clevis pin and retaining rings (split pins for ø40) are included.

## Mounting Brackets, Accessories/Material, Surface Treatment

Segment	Description	Material	Surface treatment
Mounting brackets	Foot	Carbon steel	Nickel plating
	Flange	Carbon steel	Nickel plating
	Single clevis	Carbon steel	Nickel plating
	Double clevis	Carbon steel	Nickel plating
	Trunnion	Cast iron	Electroless nickel plating
Accessories	Rod end nut	Carbon steel	Zinc chromated
	Mounting nut	Carbon steel	Nickel plating
	Trunnion nut	Carbon steel	Nickel plating
	Clevis pivot bracket	Carbon steel	Nickel plating
	Clevis pivot bracket pin	Carbon steel	(None)
	Single knuckle joint	Carbon steel ø40: Free cutting steel	Electroless nickel plating
	Double knuckle joint	Carbon steel ø40: Cast iron	Electroless nickel plating Metallic silver color painted for ø40
	Double clevis pin	Carbon steel	(None)
	Double knuckle joint pin	Carbon steel	(None)
	Pivot bracket	Carbon steel	Nickel plating
	Pivot bracket pin	Carbon steel	(None)

## Weights

		(kg)			
Bore size (mm)		20	25	32	40
Basic weight	Basic	0.14	0.21	0.28	0.57
	Axial foot	0.29	0.37	0.44	0.84
	Flange	0.20	0.30	0.37	0.69
	Integrated clevis	0.12	0.19	0.27	0.53
	Single clevis	0.18	0.25	0.32	0.66
	Double clevis	0.19	0.27	0.33	0.70
	Trunnion	0.18	0.28	0.34	0.67
	Boss-cut/Basic	0.13	0.19	0.26	0.53
	Boss-cut/Flange	0.19	0.28	0.35	0.66
	Boss-cut/Trunnion	0.17	0.26	0.32	0.63
Additional weight per 50 mm of stroke		0.04	0.07	0.09	0.14
Weight reduction for female rod end		-0.01	-0.02	-0.02	-0.04
Option bracket	Clevis pivot bracket (with pin)	0.07	0.07	0.14	0.14
	Single knuckle joint	0.06	0.06	0.06	0.23
	Double knuckle joint (with pin)	0.07	0.07	0.07	0.20

Calculation: (Example) **CM2KL32-100Z**

- Basic weight.....0.44 (Foot, ø32)
  - Additional weight.....0.09/50 stroke
  - Cylinder stroke.....100 stroke
- $0.44 + 0.09 \times 100/50 = 0.62 \text{ kg}$

## ⚠ Precautions

Be sure to read this before handling the products. Refer to back page 50 for Safety Instructions and pages 3 to 12 for Actuator and Auto Switch Precautions.

## Handling

### ⚠ Warning

- Do not rotate the cover.**  
If a cover is rotated when installing a cylinder or screwing a fitting into the port, it is likely to damage the junction part with cover.
- Do not operate with the cushion needle in a fully closed condition.**  
Using it in the fully closed state will cause the cushion seal to be damaged. When adjusting the cushion needle, use the "Hexagon wrench key: nominal size 1.5".
- Do not open the cushion needle wide excessively.**  
If the cushion needle were set to be completely wide (more than 3 turns from fully closed), it would be equivalent to the cylinder with no cushion, thus making the impacts extremely high. Do not use it in such a way. Besides, using with fully open could give damage to the piston or cover.
- Do not open the cushion needle after rotating it numerous times in a row.** Though uncommon, there are cases in which the cushion needle may leak air.  
The cushion needle should be adjusted by gradually opening it while checking the operation of the cylinder cushion. In the unlikely event that air leakage occurs, return the cushion needle to the fully-closed state, and readjust the cushion needle to the desired position.

### ⚠ Caution

- Avoid using the air cylinder in such a way that rotational torque would be applied to the piston rod.**  
If rotational torque is applied, the non-rotating guide will become deformed, thus affecting the non-rotating accuracy.  
Refer to the table below for the approximate values of the allowable range of rotational torque.

Allowable rotational torque (N·m or less)	ø20	ø25	ø32	ø40
	0.2	0.25	0.25	0.44

To screw a bracket or a nut onto the threaded portion at the tip of the piston rod, make sure to retract the piston rod entirely, and place a wrench over the flat portion of the rod, return protrudes.  
Tighten it by giving consideration to prevent the tightening torque from being applied to the non-rotating guide.

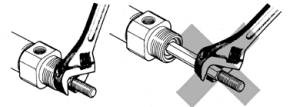

- When replacing rod seals, please contact SMC.**  
Air leakage may be happened, depending on the position in which a rod seal is fitted. Thus, please contact SMC when replacing them.
- Not able to disassemble.**  
Cover and cylinder tube are connected to each other by caulking method, thus making it impossible to disassemble. Therefore, internal parts of a cylinder other than rod seal are not replaceable.
- Do not touch the cylinder during operation.**  
Use caution when handling a cylinder, which is running at a high speed and a high frequency, because the surface of a cylinder tube could get so hot enough as to cause you get burned.
- The oil stuck to the cylinder is grease.**
- The base oil of grease may seep out.**
- When using a rod end bracket and/or pivot bracket, make sure they do not interfere with other brackets, workpieces and rod section, etc.**
- Combine the rod end section, so that a rod boot might not be twisted.**  
If a rod boot is installed with being twisted when installing a cylinder, it will cause a rod boot to fail during operation.

CJ1

CJP

CJ2

JCM

CM2

CM3

CG1

CG3

JMB

MB

MB1

CA2

CS1

CS2

D-□

-X□

Technical Data

# CM2K Series

## Construction

### Rubber bumper

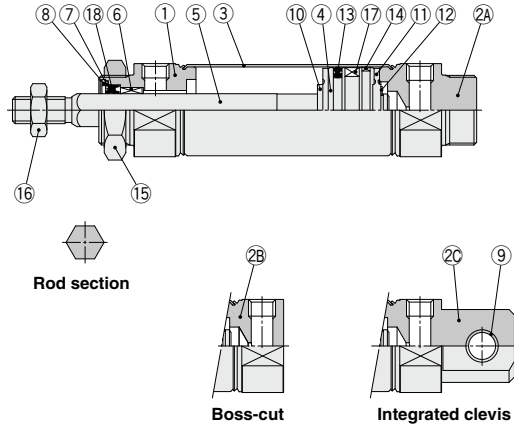

### With air cushion

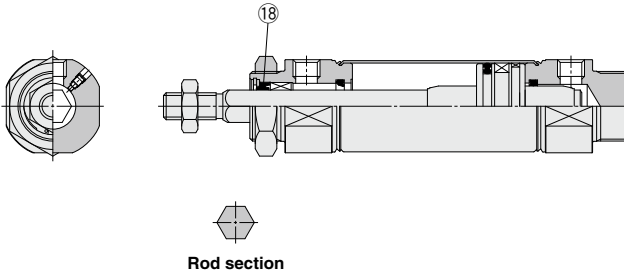

### Component Parts

No.	Description	Material	Note
1	Rod cover	Aluminum alloy	Anodized
2A	Head cover A	Aluminum alloy	Anodized
2B	Head cover B	Aluminum alloy	Anodized
2C	Head cover C	Aluminum alloy	Anodized
3	Cylinder tube	Stainless steel	
4	Piston	Aluminum alloy	
5	Piston rod	Stainless steel	
6	Non-rotating guide	Bearing alloy	
7	Seal retainer	Carbon steel	Nickel plating
8	Retaining ring	Carbon steel	Phosphate coating
9	Clevis bushing	Copper oil-impregnated sintered alloy	
10	Bumper	Resin	
11	Bumper	Resin	

No.	Description	Material	Note
12	Retaining ring	Stainless steel	
13	Piston seal	NBR	
14	Wear ring	Resin	
15	Mounting nut	Carbon steel	Nickel plating
16	Rod end nut	Carbon steel	Zinc chromated
17	Magnet	—	CDM2K□20 to 40-□Z
18	Rod seal	NBR	

### Replacement Part: Seal

#### ● With Rubber Bumper/With Air Cushion

No.	Description	Material	Part no.			
			20	25	32	40
18	Rod seal	NBR	CM2K20-PS	CM2K25-PS	CM2K32-PS	CM2K40-PS

\* Since the seal does not include a grease pack, order it separately.  
Grease pack part number: GR-S-010 (10 g)

**Basic (Double-side Bossed) (B)**

CM2KB  –

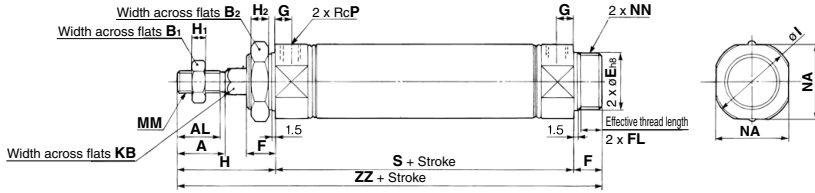

**With rod boot**

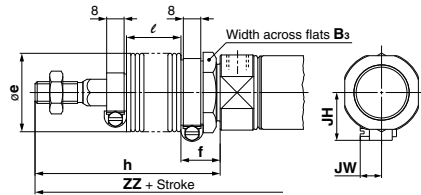

**Boss-cut**

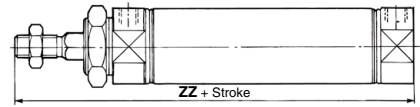

**With air cushion**

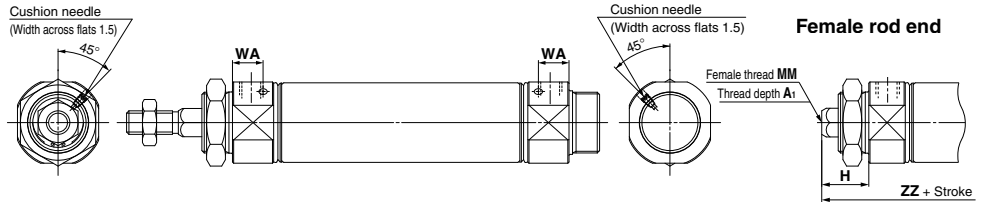

Bore size	(mm)																		
	A	AL	B <sub>1</sub>	B <sub>2</sub>	E	F	FL	G	H	H <sub>1</sub>	H <sub>2</sub>	I	KB	MM	NA	NN	P	S	ZZ
20	18	15.5	13	26	20.0 <sup>±0.033</sup>	13	10.5	8	41	5	8	28	8.2	M8 x 1.25	24	M20 x 1.5	1/8	62	116
25	22	19.5	17	32	26.0 <sup>±0.033</sup>	13	10.5	8	45	6	8	33.5	10.2	M10 x 1.25	30	M26 x 1.5	1/8	62	120
32	22	19.5	17	32	26.0 <sup>±0.033</sup>	13	10.5	8	45	6	8	37.5	12.2	M10 x 1.25	34.5	M26 x 1.5	1/8	64	122
40	24	21	22	41	32.0 <sup>±0.039</sup>	16	13.5	11	50	8	10	46.5	14.2	M14 x 1.5	42.5	M32 x 2	1/4	88	154

**With Rod Boot**

Bore size	(mm)																				
	B <sub>3</sub>	e	f	h						l					ZZ					JH	JW
				1 to 50	51 to 100	101 to 150	151 to 200	201 to 300	1 to 50	51 to 100	101 to 150	151 to 200	201 to 300	1 to 50	51 to 100	101 to 150	151 to 200	201 to 300			
20	30	36	18	68	81	93	106	131	12.5	25	37.5	50	75	143	156	168	181	206	23.5	10.5	
25	32	36	18	72	85	97	110	135	12.5	25	37.5	50	75	147	160	172	185	210	23.5	10.5	
32	32	36	18	72	85	97	110	135	12.5	25	37.5	50	75	149	162	174	187	212	23.5	10.5	
40	41	46	20	77	90	102	115	140	12.5	25	37.5	50	75	181	194	206	219	244	27	10.5	

**Boss-cut**

Bore size	(mm)					
	ZZ					
	Without rod boot	1 to 50	51 to 100	101 to 150	151 to 200	201 to 300
20	103	130	143	155	168	193
25	107	134	147	159	172	197
32	109	136	149	161	174	199
40	138	165	178	190	203	228

**With Air Cushion**

Bore size	WA
20	13
25	13
32	13
40	16

**Female Rod End**

Bore size	A <sub>1</sub>	H	MM	ZZ
20	8	20	M4 x 0.7	95
25	8	20	M5 x 0.8	95
32	12	20	M6 x 1	97
40	13	21	M8 x 1.25	125

\* When female thread is used, use a thin wrench when tightening the piston rod.

\* When female thread is used, use a washer etc. to prevent the contact part at the rod end from being deformed depending on the material of the workpiece.

**Dimensions of Each Mounting Bracket**

The dimensions are the same as standard type, double acting, single rod, except the configuration of the piston rod. Refer to pages 181 to 188. Specifications for the auto switch equipped type are the same as the CDM2 series standard type.

- CJ1
- CJP
- CJ2
- JCM
- CM2
- CM3
- CG1
- CG3
- JMB
- MB
- MB1
- CA2
- CS1
- CS2

D-  
 -X  
Technical Data

# Air Cylinder: Non-rotating Rod Type Double Acting, Double Rod

## CM2KW Series

ø20, ø25, ø32, ø40



### How to Order

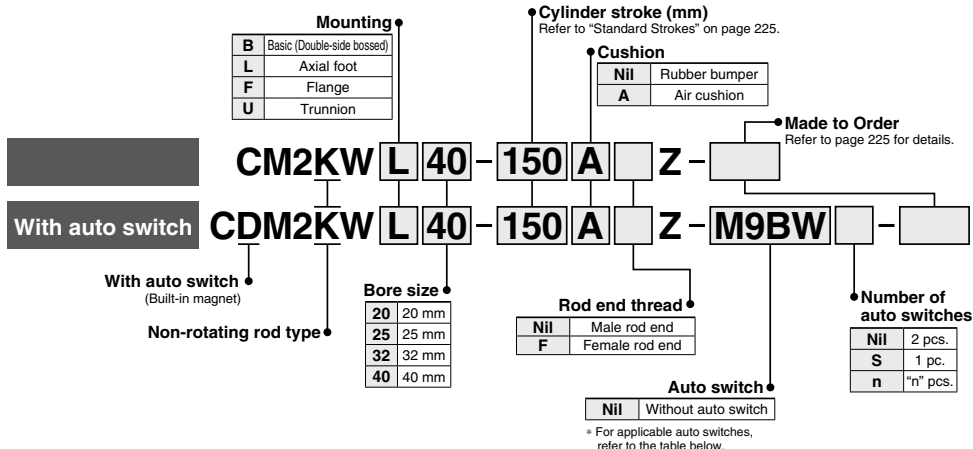

### Applicable Auto Switches/Refer to pages 1575 to 1701 for further information on auto switches.

Type	Special function	Electrical entry	Indicator Light	Wiring (Output)	Load voltage		Auto switch model		Lead wire length (m)					Pre-wired connector	Applicable load				
					DC	AC	Perpendicular	In-line	0.5	1	3	5	None						
									(Nil)	(L)	(L)	(Z)				(N)			
Solid state auto switch	—	Grommet	—	3-wire (NPN)	5 V, 12 V	—	M9NV	M9N	●	●	●	●	—	—	—	IC circuit			
				3-wire (PNP)			M9PV	M9P	●	●	●	●	—	—					
		Connector		2-wire	12 V	—	M9BV	M9B	●	●	●	●	—	—	—	—	—		
				Terminal conduit			2-wire	H7C	—	—	—	—	—	—	—	—			
		Diagnostic indication (2-color indicator)		Grommet	—	3-wire (NPN)	24 V	5 V, 12 V	—	—	G39A**	—	—	—	—	—	—	—	IC circuit
						3-wire (PNP)				—	K39A**	—	—	—	—	—	—	—	
	Water resistant (2-color indicator)		Grommet			—	2-wire	12 V	—	—	M9NVV	M9NV	●	●	●	●	—	—	IC circuit
							3-wire (PNP)				M9PVV	M9PV	●	●	●	●	—	—	
	Reed auto switch	—	Grommet	—	3-wire (NPN)	24 V	12 V	—	M9NVV	M9NV	●	●	●	●	—	—	IC circuit		
					3-wire (PNP)				M9PVV	M9PV	●	●	●	●	—	—			
Connector			2-wire		24 V	12 V	—	—	—	M9NAV*1	M9NA*1	○	○	○	○	—	—	—	
			Terminal conduit							M9PAV*1	M9PA*1	○	○	○	○	—	—		
Diagnostic indication (2-color indicator)			Grommet		—	2-wire	12 V	—	—	M9BAV*1	M9BA*1	○	○	○	○	—	—	—	
						DIN terminal				4-wire (NPN)	5 V, 12 V	—	H7NF	●	—	●	—		—
Reed auto switch	—	Grommet	—	3-wire (NPN equivalent)	24 V	12 V	—	A96V	A96	●	—	—	—	—	—	IC circuit			
				100 V				A93V*2	A93	●	●	●	●	—	—		—		
		Connector		2-wire	24 V	12 V	—	—	—	A90V	A90	●	—	—	—	—	—	IC circuit	
				Terminal conduit						100 V or less	—	B54**	●	—	●	—	—		—
		Diagnostic indication (2-color indicator)		Grommet	—	2-wire	24 V	12 V	—	—	B64**	●	—	—	—	—	—	—	
						DIN terminal				24 V or less	—	C73C	●	—	●	—	—		—
Diagnostic indication (2-color indicator)	Grommet	—	2-wire	24 V	12 V	—	—	C80C	●	—	●	—	—	—	IC circuit				
			DIN terminal				—	—	A33A**	—	—	—	—	—		—	—	—	—
Diagnostic indication (2-color indicator)	Grommet	—	2-wire	24 V	12 V	—	—	A34A**	—	—	—	—	—	—	—				
			DIN terminal				100 V, 200 V	—	A44A**	—	—	—	—	—		—	—	—	—
Diagnostic indication (2-color indicator)	Grommet	—	2-wire	24 V	12 V	—	—	B59W	●	—	●	—	—	—	—				
			DIN terminal				—	—	—	—	—	—	—	—		—	—	—	

\*1 Water resistant type auto switches can be mounted on the above models, but in such case SMC cannot guarantee water resistance.

\*2 Please contact SMC regarding water resistant types with the above model numbers.

\*3 2 1 m type lead wire is only applicable to D-A93.

\*4 Lead wire length symbols: 0.5 m ..... Nil (Example) M9NV  
1 m ..... M (Example) M9NVW  
3 m ..... L (Example) M9NWL  
5 m ..... Z (Example) M9NVZ  
None ..... N (Example) H7CN

\*5 Solid state auto switches marked with "○" are produced upon receipt of order.

\*6 Do not indicate suffix "N" for no lead wire on the D-A3□□/A44A/G39A/K39A models.

\*7 D-A3□□/A44A/G39A/K39A/B54/B64 cannot be mounted on bore sizes ø20 and ø25 cylinder with air cushion.

\*8 Since there are other applicable auto switches than listed above, refer to page 266 for details.

\*9 For details about auto switches with pre-wired connector, refer to pages 1648 and 1649.

\*10 The D-A9□□/M9□□□□ auto switches are shipped together, (but not assembled). (However, only the auto switch mounting brackets are assembled before shipment.)

**A cylinder which rod does not rotate because of the hexagonal rod shape.**

**Non-rotating accuracy**

∅20, ∅25  $\pm 0.7^\circ$

∅32, ∅40  $\pm 0.5^\circ$

**Can operate without lubrication.**

**The same installation dimensions as the standard cylinder.**

**Auto switches can also be mounted.**

It can be installed with auto switches to simplify the detection of the stroke position of the cylinder.

### Symbol

Rubber bumper

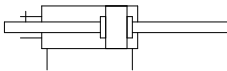

Air cushion

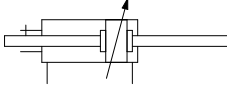

**Made to Order: Individual Specifications**  
(For details, refer to page 267.)

Symbol	Specifications
-X446	PTFE grease

### Made to Order

[Click here for details](#)

Symbol	Specifications
-XA□	Change of rod end shape
-XB6	Heat resistant cylinder (-10 to 150°C)
-XC3	Special port location
-XC6	Made of stainless steel
-XC13	Auto switch rail mounting
-XC22	Fluororubber seal
-XC25	No fixed throttle of connection port*
-XC52	Mounting nut with set screw
-XC85	Grease for food processing equipment

\* Rubber bumper only.

## Specifications

Bore size (mm)		20	25	32	40	
Rod non-rotating accuracy		$\pm 0.7^\circ$			$\pm 0.5^\circ$	
Type		Pneumatic				
Cushion		Rubber bumper, Air cushion				
Action		Double acting, Double rod				
Fluid		Air				
Proof pressure		1.5 MPa				
Maximum operating pressure		1.0 MPa				
Minimum operating pressure		0.08 MPa				
Ambient and fluid temperature		Without auto switch: $-10^\circ\text{C}$ to $70^\circ\text{C}$ (No freezing) With auto switch: $-10^\circ\text{C}$ to $60^\circ\text{C}$				
Lubrication		Not required (Non-lube)				
Stroke length tolerance		$\pm \frac{1}{4}$ mm				
Piston speed		50 to 500 mm/s				
Allowable kinetic energy	Rubber bumper	Male thread	0.27 J	0.4 J	0.65 J	1.2 J
		Female thread	0.11 J	0.18 J	0.29 J	0.52 J
	Air cushion (Effective cushion length (mm))	Male thread	0.54 J (11.0)	0.78 J (11.0)	1.27 J (11.0)	2.35 J (11.8)
		Female thread	0.11 J	0.18 J	0.29 J	0.52 J

## Standard Strokes

Bore size (mm)	Standard stroke (mm) <sup>Note 1)</sup>	Maximum manufacturable stroke (mm)
20	25, 50, 75, 100, 125, 150, 200, 250, 300	500
25		
32		
40		

Note 1) Intermediate strokes not listed above are produced upon receipt of order.

Manufacture of intermediate strokes in 1 mm increments is possible. (Spacers are not used.)

Note 2) Applicable strokes should be confirmed according to the usage. For details, refer to "Air Cylinders Model Selection" on front matter pages. In addition, the products that exceed the standard stroke might not be able to fulfill the specifications due to the deflection etc.

## Accessories

Refer to pages 189 and 190 for accessories, since it is the same as standard type, double acting, single rod.

\* Stainless steel mounting brackets and accessories are also available.

Refer to page 190 for details.

## Mounting and Accessories

Accessory	Standard		Option		
	Mounting nut	Rod end nut	Single knuckle joint	Double knuckle joint <sup>Note 2)</sup>	Pivot bracket
Mounting					
Basic	● (1 pc.)	● (2 pcs.)	●	●	—
Axial foot	● (2 pcs.)	● (2 pcs.)	●	●	
Flange	● (1 pc.)	● (2 pcs.)	●	●	
Trunnion	● (1 pc.) <sup>Note 1)</sup>	● (2 pcs.)	●	●	

Note 1) Trunnion nut is attached to the trunnion.

Note 2) A pin and retaining rings (split pins for ∅40) are shipped together with double knuckle joint.

Refer to pages 262 to 266 for cylinders with auto switches.

- Auto switch proper mounting position (detection at stroke end) and its mounting height
- Minimum stroke for auto switch mounting
- Operating range
- Auto switch mounting brackets/Part no.

CG1

CGP

CG2

JCM

CM2

CM3

CG1

CG3

JMB

MB

MB1

CA2

CS1

CS2

D-□

-X□

Technical Data

# CM2KW Series

## Weights

Bore size (mm)		20	25	32	40
Basic weight	Basic (Double-side bossed)	0.16	0.25	0.32	0.66
	Axial foot	0.31	0.41	0.48	0.93
	Flange	0.22	0.34	0.41	0.78
	Trunnion	0.20	0.32	0.38	0.76
Additional weight per 50 mm of stroke		0.06	0.1	0.14	0.20
Weight reduction for female rod end		-0.02	-0.04	-0.04	-0.08
Option bracket	Single knuckle joint	0.06	0.06	0.06	0.23
	Double knuckle joint (with pin)	0.07	0.07	0.07	0.20

Calculation: (Example) **CM2KWL32-100Z**

- Basic weight.....0.48 (Foot, ø32)
- Additional weight.....0.14/50 stroke
- Cylinder stroke.....100 stroke

$$0.48 + 0.14 \times 100/50 = 0.76 \text{ kg}$$

## Mounting Brackets/Part No.

Mounting bracket	Min. order qty	Bore size (mm)			Contents (for minimum order quantity)
		20	25	32	
Axial foot *	2	CM-L020B	CM-L032B	CM-L040B	2 feet, 1 mounting nut
Flange	1	CM-F020B	CM-F032B	CM-F040B	1 flange
Trunnion (with nut)	1	CM-T020B	CM-T032B	CM-T040B	1 trunnion, 1 trunnion nut

\* Order 2 feet per cylinder unit.

## ⚠ Precautions

Be sure to read this before handling the products. Refer to back page 50 for Safety Instructions and pages 3 to 12 for Actuator and Auto Switch Precautions.

### Handling

#### ⚠ Warning

- Do not rotate the cover.**  
If a cover is rotated when installing a cylinder or screwing a fitting into the port, it is likely to damage the junction part with cover.
- Do not operate with the cushion needle in a fully closed condition.**  
Using it in the fully closed state will cause the cushion seal to be damaged. When adjusting the cushion needle, use the "Hexagon wrench key: nominal size 1.5".
- Do not open the cushion needle wide excessively.**  
If the cushion needle were set to be completely wide (more than 3 turns from fully closed), it would be equivalent to the cylinder with no cushion, thus making the impacts extremely high. Do not use it in such a way. Besides, using with fully open could give damage to the piston or cover.
- Do not open the cushion needle after rotating it numerous times in a row. Though uncommon, there are cases in which the cushion needle may leak air.**  
The cushion needle should be adjusted by gradually opening it while checking the operation of the cylinder cushion. In the unlikely event that air leakage occurs, return the cushion needle to the fully-closed state, and readjust the cushion needle to the desired position.

#### ⚠ Caution

- Avoid using the air cylinder in such a way that rotational torque would be applied to the piston rod.**

If rotational torque is applied, the non-rotating guide will become deformed, thus affecting the non-rotating accuracy. Refer to the table below for the approximate values of the allowable range of rotational torque.

Allowable rotational torque (N·m or less)	ø20	ø25	ø32	ø40
	0.2	0.25	0.25	0.44

To screw a bracket or a nut onto the threaded portion at the tip of the piston rod, make sure to retract the piston rod entirely, and place a wrench over the flat portion of the rod that protrudes. Tighten it by giving consideration to prevent the tightening torque from being applied to the non-rotating guide.

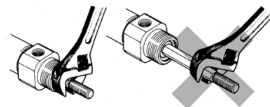

- When replacing rod seals, please contact SMC.**  
Air leakage may be happened, depending on the position in which a rod seal is fitted. Thus, please contact SMC when replacing them.
- Not able to disassemble.**  
Cover and cylinder tube are connected to each other by caulking method, thus making it impossible to disassemble. Therefore, internal parts of a cylinder other than rod seal are not replaceable.
- Do not touch the cylinder during operation.**  
Use caution when handling a cylinder, which is running at a high speed and a high frequency, because the surface of a cylinder tube could get so hot enough as to cause you get burned.
- The oil stuck to the cylinder is grease.**
- The base oil of grease may seep out.**
- When using a rod end bracket, make sure it does not interfere with other brackets, workpieces and rod section, etc.**



## Construction

### Rubber bumper

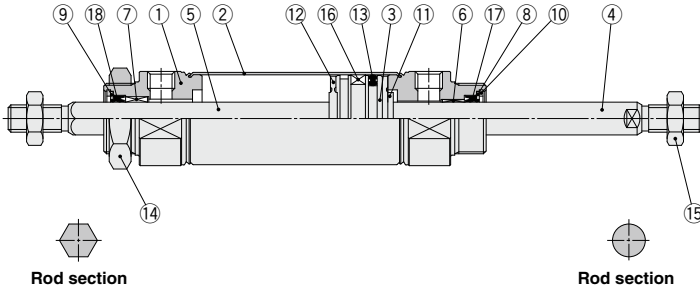

### With air cushion

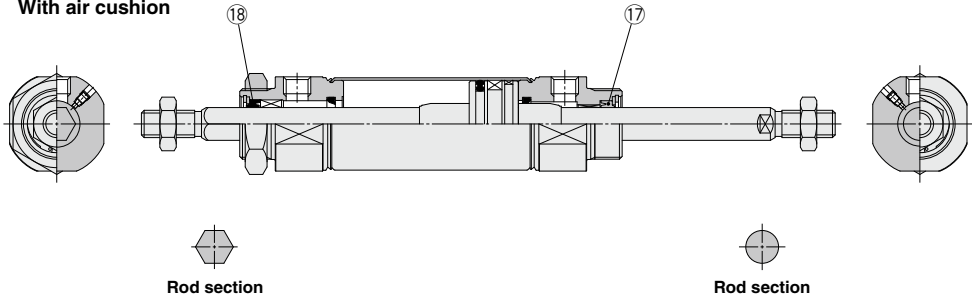

### Component Parts

No.	Description	Material	Note
1	Rod cover	Aluminum alloy	Anodized
2	Cylinder tube	Stainless steel	
3	Piston	Aluminum alloy	
4	Piston rod A	Carbon steel	Hard chrome plating
5	Piston rod B	Stainless steel	
6	Bushing	Bearing alloy	
7	Non-rotating guide	Bearing alloy	
8	Seal retainer A	Stainless steel	
9	Seal retainer B	Carbon steel	Nickel plating
10	Retaining ring	Carbon steel	Phosphate coating
11	Bumper	Resin	
12	Bumper	Resin	
13	Piston seal	NBR	
14	Mounting nut	Carbon steel	Zinc chromated
15	Rod end nut	Carbon steel	Nickel plating
16	Magnet	—	CDM2KW□20 to 40-□Z
17	Rod seal A	NBR	
18	Rod seal B	NBR	

### Replacement Parts: Seal

#### ● With Rubber Bumper/With Air Cushion

No.	Description	Material	Bore size (mm)			
			20	25	32	40
17	Rod seal A	NBR	CM20Z-PS	CM25Z-PS	CM32Z-PS	CM40Z-PS
18	Rod seal B	NBR	CM2K20-PS	CM2K25-PS	CM2K32-PS	CM2K40-PS

\* Since the seal does not include a grease pack, order it separately.  
**Grease pack part number: GR-S-010 (10 g)**

CJ1  
CJP  
CJ2  
JCM  
**CM2**  
CM3  
CG1  
CG3  
JMB  
MB  
MB1  
CA2  
CS1  
CS2

D-□  
-X□  
Technical Data

# CM2KW Series

## Basic (Double-side Bossed) (B)

CM2KWB Bore size – Stroke Z

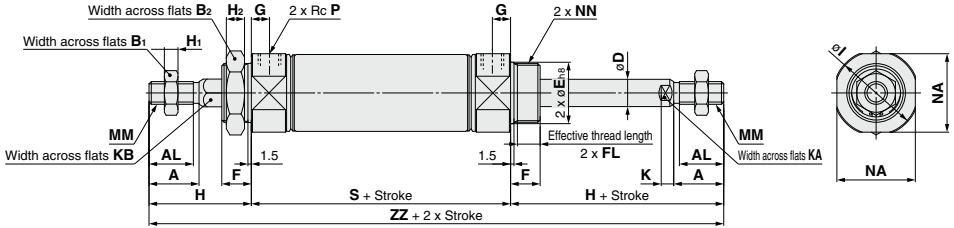

### With air cushion

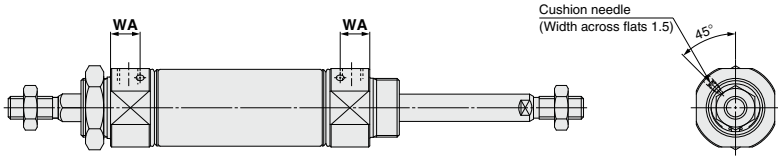

### Female rod end

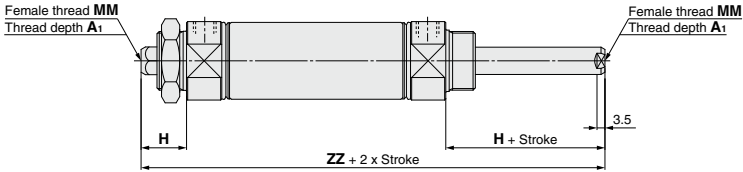

Bore size	A	AL	B <sub>1</sub>	B <sub>2</sub>	D	E	F	FL	G	H	H <sub>1</sub>	H <sub>2</sub>	I	K	KA	KB	MM	NA	NN	P	S	ZZ
20	18	15.5	13	26	8	20 <sup>+0.033</sup>	13	10.5	8	41	5	8	28	5	6	8.2	M8 x 1.25	24	M20 x 1.5	1/8	62	144
25	22	19.5	17	32	10	26 <sup>+0.033</sup>	13	10.5	8	45	6	8	33.5	5.5	8	10.2	M10 x 1.25	30	M26 x 1.5	1/8	62	152
32	22	19.5	17	32	12	26 <sup>+0.033</sup>	13	10.5	8	45	6	8	37.5	5.5	10	12.2	M10 x 1.25	34.5	M26 x 1.5	1/8	64	154
40	24	21	22	41	14	32 <sup>+0.033</sup>	16	13.5	11	50	8	10	46.5	7	12	14.2	M14 x 1.5	42.5	M32 x 2	1/4	88	188

### With Air Cushion (mm)

Bore size	WA
20	13
25	13
32	13
40	16

### Female Rod End (mm)

Bore size	A <sub>1</sub>	H	MM	ZZ
20	8	20	M4 x 0.7	102
25	8	20	M5 x 0.8	102
32	12	20	M6 x 1	104
40	13	21	M8 x 1.25	130

\* When female thread is used, use a thin wrench when tightening the piston rod.

\* When female thread is used, use a washer etc. to prevent the contact part at the rod end from being deformed depending on the material of the workpiece.

## Dimensions of Each Mounting Bracket

The dimensions of each mounting bracket other than basic type are the same as standard type, double acting, double rod (except KA dimension). Refer to pages 200 to 202.

# Air Cylinder: Non-rotating Rod Type Single Acting, Spring Return/Extend

## CM2K Series

ø20, ø25, ø32, ø40

RoHS

### How to Order



<b>B</b>	Basic (Double-side bossed)
<b>L</b>	Axial foot
<b>F</b>	Rod flange
<b>G</b>	Head flange
<b>C</b>	Single clevis
<b>D</b>	Double clevis
<b>U</b>	Rod trunnion

<b>T</b>	Head trunnion
<b>E</b>	Integrated clevis
<b>V</b>	Integrated clevis (90°)
<b>BZ</b>	Boss-cut/Basic
<b>FZ</b>	Boss-cut/Rod flange
<b>UZ</b>	Boss-cut/Rod trunnion

**Mounting**      **Cylinder stroke (mm)**  
Refer to "Standard Strokes" on page 230.

<b>S</b>	Single acting, Spring return
<b>T</b>	Single acting, Spring extend

**Action**

<b>NII</b>	Male rod end
<b>F</b>	Female rod end

**Rod end thread**

<b>NII</b>	None
<b>N</b>	Pivot bracket is shipped together with the product, but not assembled.

**Pivot bracket**

\* Only for C, T, U, E, V, UZ mounting types.  
\* Pivot bracket is shipped together with the product, but not assembled.

**CM2K L 32 - 150 S [ ] Z - [ ] - [ ]**

**With auto switch**      **With auto switch (Built-in magnet)**

**CDM2K L 32 - 150 S [ ] Z - [ ] - [ ] M9BW [ ] - [ ]**

<b>20</b>	20 mm
<b>25</b>	25 mm
<b>32</b>	32 mm
<b>40</b>	40 mm

**Bore size**

<b>NII</b>	None
<b>V</b>	Single knuckle joint
<b>W</b>	Double knuckle joint

**Rod end bracket**

<b>NII</b>	Without auto switch
------------	---------------------

**Auto switch**

\* For applicable auto switches, refer to the table below.

<b>NII</b>	2 pcs.
<b>S</b>	1 pc.
<b>n</b>	"n" pcs.

**Number of auto switches**

\* No bracket is provided for the female rod end.  
\* A knuckle joint pin is not provided with the single knuckle joint.  
\* Rod end bracket is shipped together with the product, but not assembled.  
\* Not applicable to XB12.

**Made to Order**  
Refer to page 230 for details.

\* Refer to "Ordering Example of Cylinder Assembly" on page 230.

### Applicable Auto Switches/Refer to pages 1575 to 1701 for further information on auto switches.

Type	Special function	Electrical entry	Indicator light	Wiring (Output)	Load voltage		Auto switch model		Lead wire length (m)				Pre-wired connector	Applicable load				
					DC	AC	Perpendicular	In-line	0.5 (NII)	1 (M)	3 (L)	5 (Z)			None (N)			
Solid state auto switch	—	Grommet	—	3-wire (NPN)	5 V, 12 V	—	M9NV	M9N	●	●	●	○	—	○	IC circuit			
				3-wire (PNP)			M9PV	M9P	●	●	●	○	—	○				
		Connector		2-wire	M9BV		M9B	●	●	●	○	—	○	—				
				3-wire (NPN)	—		H7C	●	●	●	○	—	○					
		Terminal conduit		2-wire	—		G39A	—	—	—	●	●	—	—		—	—	IC circuit
				3-wire (PNP)	—		K39A	—	—	—	●	●	—	—		—	—	
	Diagnostic indication (2-color indicator)	Grommet	—	3-wire (NPN)	24 V	5 V, 12 V	M9NVV	M9NV	●	●	●	○	—	○	IC circuit			
				3-wire (PNP)			M9PVV	M9PV	●	●	●	○	—	○				
				2-wire			M9BVV	M9BV	●	●	●	○	—	○				
				3-wire (NPN)			M9NAV*1	M9NA*1	○	○	○	○	—	○		IC circuit		
3-wire (PNP)	M9PAV*1	M9PA*1	○	○	○	○	—	○										
Water resistant (2-color indicator)	Grommet	—	2-wire	5 V, 12 V	12 V	M9BAV*1	M9BA*1	○	○	○	○	—	○	—				
			4-wire (NPN)			—	H7NF	●	—	●	○	—	○		IC circuit			
Reed auto switch	—	Grommet	—	3-wire (NPN equivalent)	24 V	5 V	A96V	A96	●	●	—	—	—	—	IC circuit			
				100 V			A93V*2	A93	●	●	●	—	—	—				
				100 V or less			A90V	A90	●	●	●	—	—	—		IC circuit		
				100 V, 200 V			—	B54	●	●	●	—	—	—				
				200 V or less			—	B64	●	●	●	—	—	—				
		Connector		—	—	2-wire	24 V	12 V	—	C73C	●	●	●	●	—	—	IC circuit	
									—	C80C	●	●	●	●	—	—		
									—	A33A	—	—	—	—	—	—		PLC
									100 V,	A34A	—	—	—	—	●	—		
									200 V	A44A	—	—	—	—	●	—		
Terminal conduit	—	—	—	—	—	—	B59W	●	●	—	—	—	IC circuit					
						—	—	—	—	—	—	—		—	Relay, PLC			
DIN terminal	—	—	—	—	—	—	—	—	—	—	—	—	—					
						Grommet	—	—	—	—	—	—		—	—	Relay, PLC		

\*1 Water resistant type auto switches can be mounted on the above models, but in such case SMC cannot guarantee water resistance.

Please contact SMC regarding water resistant types with the above model numbers.

\*2 1 m type lead wire is only applicable to D-A93.

\* Lead wire length symbols: 0.5 m .....NII (Example) M9NV  
1 m .....M (Example) M9NVW  
3 m .....L (Example) M9NWL  
5 m .....Z (Example) M9NVZ  
None .....N (Example) H7CN

\* Solid state auto switches marked with "○" are produced upon receipt of order.  
\* Do not indicate suffix "N" for no lead wire on the D-A93□A/A44A/G39A/K39A models.

\* Since there are other applicable auto switches than listed above, refer to page 266 for details.

\* For details about auto switches with pre-wired connector, refer to pages 1648 and 1649.

\* The D-A93□□M9□□□ auto switches are shipped together, (but not assembled). (However, only the auto switch mounting brackets are assembled before shipment.)

CJ1

CJP

CJ2

JCM

CM2

CM3

CG1

CG3

JMB

MB

MB1

CA2

CS1

CS2

D-□

-X□

Technical Data

# CM2K Series

A cylinder which rod does not rotate because of the hexagonal rod shape.

## Non-rotating accuracy

∅20, ∅25—±0.7°

∅32, ∅40—±0.5°

Can operate without lubrication.

The same installation dimensions as the standard cylinder.

Auto switches can also be mounted.

It can be installed with auto switches to simplify the detection of the stroke position of the cylinder.

## Symbol

Single acting, Spring return, Rubber bumper

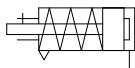

Single acting, Spring extend, Rubber bumper

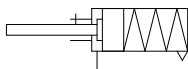

**Made to Order**

[Click here for details](#)

Symbol	Specifications
-XA□	Change of rod end shape
-XB12	External stainless steel cylinder*
-XC3	Special port location
-XC6	Made of stainless steel
-XC13	Auto switch rail mounting
-XC20	Head cover axial port
-XC25	No fixed throttle of connection port
-XC27	Double clevis and double knuckle pins made of stainless steel
-XC52	Mounting nut with set screw
-XC85	Grease for food processing equipment

\* The shape is the same as the current product.

Refer to pages 262 to 266 for cylinders with auto switches.

- Auto switch proper mounting position (detection at stroke end) and its mounting height
- Minimum stroke for auto switch mounting
- Operating range
- Auto switch mounting brackets/Part no.

## Specifications

Bore size (mm)		20	25	32	40
Rod non-rotating accuracy		±0.7°		±0.5°	
Action		Single acting, Spring return/Single acting, Spring extend			
Fluid		Air			
Cushion		Rubber bumper			
Proof pressure		1.5 MPa			
Maximum operating pressure		1.0 MPa			
Minimum operating pressure	Spring return	0.18 MPa			
	Spring extend	0.23 MPa			
Ambient and fluid temperature		Without auto switch: -10°C to 70°C (No freezing) With auto switch: -10°C to 60°C			
Lubrication		Not required (Non-lube)			
Stroke length tolerance		+1.4 0 mm			
Piston speed		50 to 500 mm/s			
Allowable kinetic energy	Male thread	0.27 J	0.4 J	0.65 J	1.2 J
	Female thread	0.11 J	0.18 J	0.29 J	0.52 J

## Standard Strokes

Bore size (mm)	Standard stroke (mm) <sup>Note)</sup>
20	25, 50, 75, 100, 125, 150
25	25, 50, 75, 100, 125, 150
32	25, 50, 75, 100, 125, 150, 200
40	25, 50, 75, 100, 125, 150, 200, 250

Note 1) Other intermediate strokes can be manufactured upon receipt of order. Manufacture of intermediate strokes at 1 mm intervals is possible. (Spacers are not used.)

Note 2) Please contact SMC for longer strokes.

Note 3) Applicable strokes should be confirmed according to the usage. For details, refer to "Air Cylinders Model Selection" on front matter pages. In addition, the products that exceed the standard stroke might not be able to fulfill the specifications due to the deflection etc.

## Mounting Bracket

For the mounting bracket part numbers other than basic type, refer to page 231.

## Theoretical Output

Refer to page 1903 (Theoretical Output 1).

## Spring Reaction Force

Refer to page 1900 (Table (3) Spring Reaction Force).

## Accessories

Refer to pages 189 and 190 for accessories, since it is the same as standard type, double acting, single rod.

## Option: Ordering Example of Cylinder Assembly

Cylinder model: CDM2KC32-150SZ-NV-M9BW

**Mounting C: Single clevis**  
**Pivot bracket N: Yes**  
**Rod end bracket V: Single knuckle joint**  
**Auto switch D-M9BW: 2 pcs.**

\* Pivot bracket, single knuckle joint and auto switch are shipped together with the product, but not assembled.

\* Pivot bracket is available only for C, T, U, E, V, UZ mounting types.  
 \* No bracket is provided for the female rod end.

## Mounting and Accessories

Accessories	Body	Standard (mounted to the body)						Standard (packaged together, but not assembled)							Option				
		Mounting nut <small>Note 1)</small>	Rod end nut (Male thread)	Single clevis	Double clevis	Liner <small>Note 7)</small>	Mounting nut	Foot	Flange	Pivot bracket	Pivot bracket pin <small>Note 5)</small>	Double clevis pin <small>Note 5)</small>	Trunnion	Mounting nut (For trunnion)	Clevis pivot bracket (CM2E/CM2V)	Clevis pivot bracket pin <small>Note 5)</small>	Clevis pivot bracket pin (CM2E/CM2V)	Single knuckle joint (Male thread only)	Double knuckle joint (Male thread only)
<b>B</b> Basic (Double-side bossed)	●(1 pc.)	●(1 pc.)	●(1 pc.)	—	—	—	—	—	—	—	—	—	—	—	—	—	—	●	●
<b>L</b> Axial foot	●(1 pc.)	●(1 pc.) <sup>Note 2)</sup>	●(1 pc.)	—	—	—	●(1 pc.) <sup>Note 2)</sup>	●(2 pcs.)	—	—	—	—	—	—	—	—	—	●	●
<b>F</b> Rod flange	●(1 pc.)	●(1 pc.)	●(1 pc.)	—	—	—	—	—	—	—	—	—	—	—	—	—	—	●	●
<b>G</b> Head flange	●(1 pc.)	●(1 pc.)	●(1 pc.)	—	—	—	—	—	—	—	—	—	—	—	—	—	—	●	●
<b>C</b> Single clevis	●(1 pc.)	— <sup>Note 3)</sup>	●(1 pc.)	●(1 pc.)	—	—	●(Max. 3 pcs.) <sup>Note 3)</sup>	—	—	—	—	—	—	—	—	—	—	●	●
<b>D</b> Double clevis	●(1 pc.)	— <sup>Note 3)</sup>	●(1 pc.)	—	—	—	●(1 pc.)	●(Max. 3 pcs.) <sup>Note 3)</sup>	—	—	—	—	—	—	—	—	—	●	●
<b>U</b> Rod trunnion	●(1 pc.)	— <sup>Note 4)</sup>	●(1 pc.)	—	—	—	—	—	—	—	—	—	—	—	—	—	—	●	●
<b>T</b> Head trunnion	●(1 pc.)	— <sup>Note 4)</sup>	●(1 pc.)	—	—	—	—	—	—	—	—	—	—	—	—	—	—	●	●
<b>E</b> Integrated clevis	●(1 pc.)	— <sup>Note 3)</sup>	●(1 pc.)	—	—	—	—	—	—	—	—	—	—	—	—	—	—	●	●
<b>V</b> Integrated clevis (90°)	●(1 pc.)	— <sup>Note 3)</sup>	●(1 pc.)	—	—	—	—	—	—	—	—	—	—	—	—	—	—	●	●
<b>BZ</b> Boss-cut/Basic	●(1 pc.)	●(1 pc.)	●(1 pc.)	—	—	—	—	—	—	—	—	—	—	—	—	—	—	●	●
<b>FZ</b> Boss-cut/ Rod flange	●(1 pc.)	●(1 pc.)	●(1 pc.)	—	—	—	—	—	—	—	—	—	—	—	—	—	—	●	●
<b>UZ</b> Boss-cut/ Rod trunnion	●(1 pc.)	— <sup>Note 4)</sup>	●(1 pc.)	—	—	—	—	—	—	—	—	—	—	—	—	—	—	●	●

Note 1) Rod end nut is not provided for the female rod end.

Note 2) Two mounting nuts are packaged together.

Note 3) Mounting nut is not packaged for the clevis.

Note 4) Trunnion nut is packaged for U, T, UZ.

Note 5) Retaining rings are included.

Note 6) A pin and retaining rings (split pins for ø40) are included.

Note 7) This is the part(s) used to adjust the clevis angle. Mounting quantity can vary.

\* Stainless steel mounting brackets and accessories are also available.

Refer to page 190 for details.

## Mounting Brackets/Part No.

Mounting bracket	Min. order qty	Bore size (mm)				Contents (for minimum order quantity)
		20	25	32	40	
Foot*	2	CM-L020B	CM-L032B	CM-L040B	20	2 feet, 1 mounting nut
Flange	1	CM-F020B	CM-F032B	CM-F040B	20	1 flange
Single clevis**	1	CM-C020B	CM-C032B	CM-C040B	20	1 single clevis, 3 liners
Double clevis (with pin)***	1	CM-D020B	CM-D032B	CM-D040B	20	1 double clevis, 3 liners, 1 clevis pin, 2 retaining rings
Double clevis pin	1	CDP-1		CDP-2	20	1 clevis pin, 2 retaining rings (split pins)
Trunnion (with nut)	1	CM-T020B	CM-T032B	CM-T040B	20	1 trunnion, 1 trunnion nut
Rod end nut	1	NT-02	NT-03	NT-04	20	1 rod end nut
Mounting nut	1	SN-020B	SN-032B	SN-040B	20	1 mounting nut
Trunnion nut	1	TN-020B	TN-032B	TN-040B	20	1 trunnion nut
Single knuckle joint	1	I-020B	I-032B	I-040B	20	1 single knuckle joint
Double knuckle joint	1	Y-020B	Y-032B	Y-040B	20	1 double knuckle joint, 1 knuckle pin, 2 retaining rings
Double knuckle joint pin	1	CDP-1		CDP-3	20	1 knuckle pin, 2 retaining rings (split pins)
Clevis pivot bracket pin (For CM2E/CM2V)	1	CD-S02		CD-S03	20	1 clevis pin, 2 retaining rings
Clevis pivot bracket (For CM2E/CM2V)	1	CM-E020B		CM-E032B	20	1 clevis pivot bracket, 1 clevis pin, 2 retaining rings
Pivot bracket (For CM2C)	1	CM-B032		CM-B040	20	2 pivot brackets (1 of each type)
Pivot bracket pin (For CM2C)	1	CDP-1		CD-S03	20	1 pin, 2 retaining rings
Pivot bracket (For CM2T)	1	CM-B020	CM-B032	CM-B040	20	2 pivot brackets (1 of each type)

\* Order 2 feet per cylinder.

\*\* 3 liners are included with a clevis bracket for adjusting the mounting angle.

\*\*\* A clevis pin and retaining rings (split pins for ø40) are included.

CJ1

CJP

CJ2

JCM

CM2

CM3

CG1

CG3

JMB

MB

MB1

CA2

CS1

CS2

D-□

-X□

Technical  
Data

## Weights

Spring Return/( ): Denotes Spring Extend.

(kg)

Bore size (mm)		20	25	32	40
Basic weight	25 stroke	0.20 (0.19)	0.31 (0.30)	0.43 (0.41)	0.78 (0.75)
	50 stroke	0.23 (0.21)	0.34 (0.33)	0.48 (0.45)	0.86 (0.83)
	75 stroke	0.29 (0.25)	0.43 (0.41)	0.61 (0.56)	1.08 (0.99)
	100 stroke	0.31 (0.27)	0.47 (0.44)	0.66 (0.60)	1.14 (1.06)
	125 stroke	0.37 (0.32)	0.56 (0.52)	0.81 (0.72)	1.34 (1.23)
	150 stroke	0.39 (0.34)	0.59 (0.55)	0.85 (0.76)	1.39 (1.31)
	200 stroke	– (–)	– (–)	1.04 (0.92)	1.71 (1.54)
Mounting brackets	250 stroke	– (–)	– (–)	– (–)	2.00 (1.78)
	Foot	0.15 (0.15)	0.16 (0.16)	0.16 (0.16)	0.27 (0.27)
	Flange	0.06 (0.06)	0.09 (0.09)	0.09 (0.09)	0.12 (0.12)
	Single clevis	0.04 (0.04)	0.04 (0.04)	0.04 (0.04)	0.09 (0.09)
	Double clevis	0.05 (0.05)	0.06 (0.06)	0.06 (0.06)	0.13 (0.13)
	Trunnion	0.04 (0.04)	0.07 (0.07)	0.07 (0.07)	0.10 (0.10)
	Integrated clevis	–0.02 (–0.02)	–0.02 (–0.02)	–0.01 (–0.01)	–0.04 (–0.04)
	Boss-cut/Basic	–0.01 (–0.01)	–0.02 (–0.02)	–0.02 (–0.02)	–0.03 (–0.03)
	Boss-cut/Flange	0.05 (0.05)	0.07 (0.07)	0.07 (0.07)	0.09 (0.09)
	Boss-cut/Trunnion	0.03 (0.03)	0.05 (0.05)	0.05 (0.05)	0.07 (0.07)
	Clevis pivot bracket (with pin)	0.07 (0.07)	0.07 (0.07)	0.14 (0.14)	0.14 (0.14)
Weight reduction for female rod end	–0.01	–0.02	–0.02	–0.04	
Option bracket					
Single knuckle joint	0.06 (0.06)	0.06 (0.06)	0.06 (0.06)	0.23 (0.23)	
Double knuckle joint (with pin)	0.07 (0.07)	0.07 (0.07)	0.07 (0.07)	0.20 (0.20)	

Calculation

(Example) **CM2KL32-100SZ** (Bore size ø32, Foot, 100 stroke)  
 0.66 (Basic weight) + 0.16 (Mounting bracket weight) = **0.82 kg**

## ⚠ Precautions

Be sure to read this before handling the products. Refer to back page 50 for Safety Instructions and pages 3 to 12 for Actuator and Auto Switch Precautions.

### Handling

#### ⚠ Warning

##### 1. Do not rotate the cover.

If a cover is rotated when installing a cylinder or screwing a fitting into the port, it is likely to damage the junction part with cover.

#### ⚠ Caution

##### 1. Avoid using the air cylinder in such a way that rotational torque would be applied to the piston rod.

If rotational torque is applied, the non-rotating guide will become deformed, thus affecting the non-rotating accuracy.

Refer to the table below for the approximate values of the allowable range of rotational torque.

Allowable rotational torque (N·m or less)	ø20	ø25	ø32	ø40
	0.2	0.25	0.25	0.44

To screw a bracket or a nut onto the threaded portion at the tip of the piston rod, make sure to retract the piston rod entirely, and place a wrench over the flat portion of the rod that protrudes.

Tighten it by giving consideration to prevent the tightening torque from being applied to the non-rotating guide.

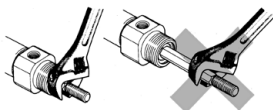

#### ⚠ Caution

##### 2. When replacing rod seals, please contact SMC.

Air leakage may be happened, depending on the position in which a rod seal is fitted. Thus, please contact SMC when replacing them.

##### 3. Not able to disassemble.

Cover and cylinder tube are connected to each other by caulking method, thus making it impossible to disassemble. Therefore, internal parts of a cylinder other than rod seal are not replaceable.

##### 4. Do not touch the cylinder during operation.

Use caution when handling a cylinder, which is running at a high speed and a high frequency, because the surface of a cylinder tube could get so hot enough as to cause you get burned.

##### 5. The oil stuck to the cylinder is grease.

##### 6. The base oil of grease may seep out.

##### 7. When using a rod end bracket and/or pivot bracket, make sure they do not interfere with other brackets, workpieces and rod section, etc.

**Construction**

**Spring return**

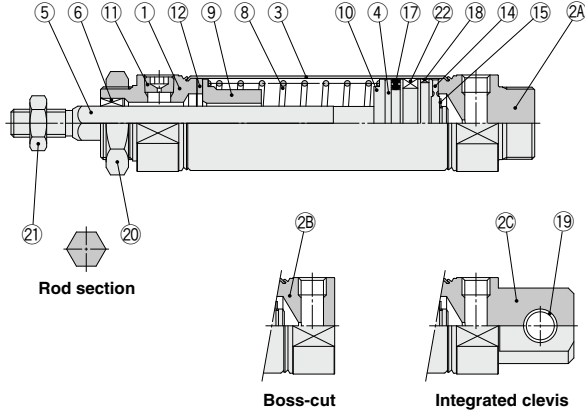

**Spring extend**

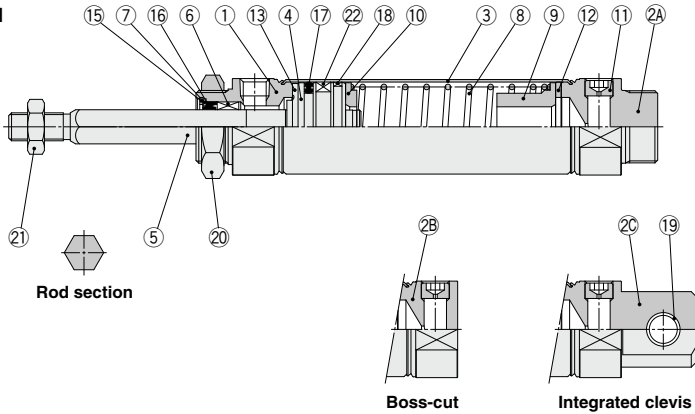

**Component Parts**

No.	Description	Material	Note
1	Rod cover	Aluminum alloy	Anodized
2A	Head cover A	Aluminum alloy	Anodized
2B	Head cover B	Aluminum alloy	Anodized
2C	Head cover C	Aluminum alloy	Anodized
3	Cylinder tube	Stainless steel	
4	Piston	Aluminum alloy	
5	Piston rod	Stainless steel	
6	Non-rotating guide	Bearing alloy	
7	Seal retainer	Carbon steel	Nickel plating
8	Return spring	Steel wire	Zinc chromated
9	Spring guide	Aluminum alloy	Chromated
10	Spring seat	Aluminum alloy	Chromated
11	Plug with fixed orifice	Alloy steel	Black zinc chromated
12	Bumper	Resin	
13	Bumper A	Resin	
14	Bumper B	Resin	

No.	Description	Material	Note
15	Retaining ring	Stainless steel	
16	Rod seal	NBR	
17	Piston seal	NBR	
18	Wear ring	Resin	
19	Clevis bushing	Bearing alloy	
20	Mounting nut	Carbon steel	Nickel plating
21	Rod end nut	Carbon steel	Zinc chromated
22	Magnet	—	CDM2K□20 to 40-□S/TZ

**Replacement Part: Seal**

No.	Description	Material	Part no.			
			20	25	32	40
16	Rod seal	NBR	CM2K20-PS	CM2K25-PS	CM2K32-PS	CM2K40-PS

\* Since the seal does not include a grease pack, order it separately.  
Grease pack part number: GR-S-010 (10 g)

CJ1
CJP
CJ2
JCM
<b>CM2</b>
CM3
CG1
CG3
JMB
MB
MB1
CA2
CS1
CS2

D-□
-X□
Technical Data

# CM2K Series

## Basic (Double-side Bossed) (B)

CM2KB Bore size – Stroke <sup>S</sup>/<sub>T</sub>  
Spring return

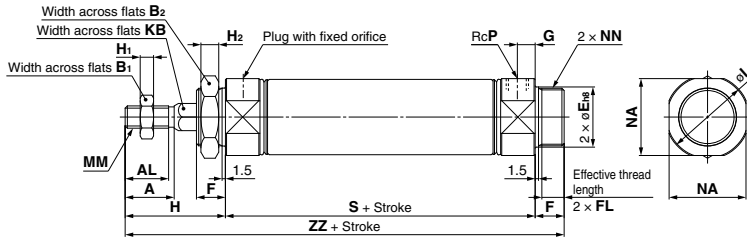

### Spring extend

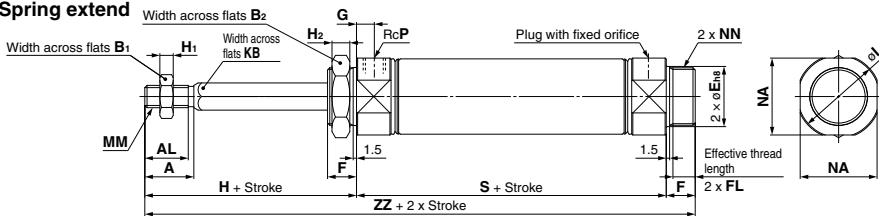

### Boss-cut

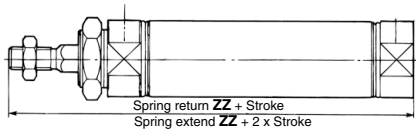

### Female rod end

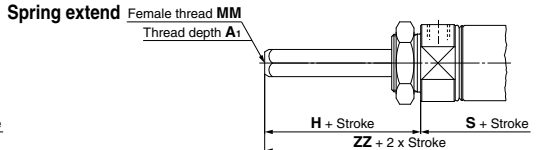
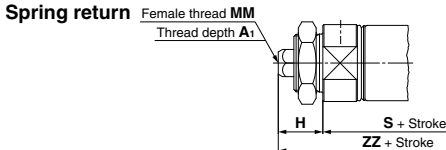

Bore size	A	AL	B1	B2	E	F	FL	G	H	H1	H2	I	KB	MM	NA	NN	P
20	18	15.5	13	26	20 <sup>0</sup> <sub>0.033</sub>	13	10.5	8	41	5	8	28	8.2	M8 x 1.25	24	M20 x 1.5	1/8
25	22	19.5	17	32	26 <sup>0</sup> <sub>0.033</sub>	13	10.5	8	45	6	8	33.5	10.2	M10 x 1.25	30	M26 x 1.5	1/8
32	22	19.5	17	32	26 <sup>0</sup> <sub>0.033</sub>	13	10.5	8	45	6	8	37.5	12.2	M10 x 1.25	34.5	M26 x 1.5	1/8
40	24	21	22	41	32 <sup>0</sup> <sub>0.039</sub>	16	13.5	11	50	8	10	46.5	14.2	M14 x 1.5	42.5	M32 x 2	1/4

### Dimensions by Stroke

Bore size	1 to 50		51 to 100		101 to 150		151 to 200		201 to 250	
	S	ZZ	S	ZZ	S	ZZ	S	ZZ	S	ZZ
20	87	141	112	166	137	191	—	—	—	—
25	87	145	112	170	137	195	—	—	—	—
32	89	147	114	172	139	197	164	222	—	—
40	113	179	138	204	163	229	188	254	213	279

### Boss-cut

Bore size	1 to 50		51 to 100		101 to 150		151 to 200		201 to 250	
	ZZ	ZZ	ZZ	ZZ	ZZ	ZZ	ZZ	ZZ	ZZ	
20	128	153	178	—	—	—	—	—	—	
25	132	157	182	—	—	—	—	—	—	
32	134	159	184	209	—	—	—	—	—	
40	163	188	213	238	263	—	—	—	—	

### Female Rod End

Bore size	A1	H	MM	(mm)									
				1 to 50		51 to 100		101 to 150		151 to 200		201 to 250	
				S	ZZ	S	ZZ	S	ZZ	S	ZZ	S	ZZ
20	8	20	M4 x 0.7	87	120	112	145	137	170	—	—	—	—
25	8	20	M5 x 0.8	87	120	112	145	137	170	—	—	—	—
32	12	20	M6 x 1	89	122	114	147	139	172	164	197	—	—
40	13	21	M8 x 1.25	113	150	138	175	163	200	188	225	213	250

\* When female thread is used, use a thin wrench when tightening the piston rod.  
\* When female thread is used, use a washer etc. to prevent the contact part at the rod end from being deformed depending on the material of the workpiece.



# Air Cylinder: Direct Mount Type Double Acting, Single Rod

## CM2R Series

ø20, ø25, ø32, ø40

RoHS



### How to Order

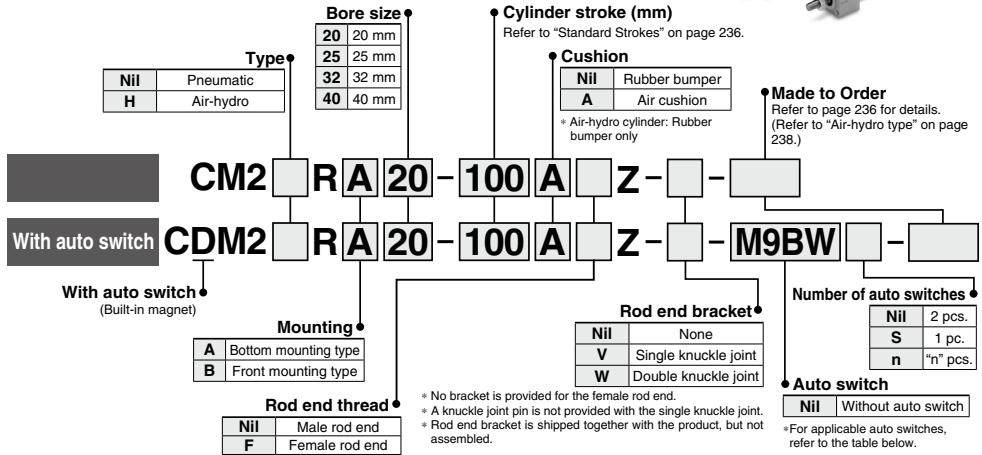

\* Refer to "Ordering Example of Cylinder Assembly" on page 236.

### Applicable Auto Switches/Refer to pages 1575 to 1701 for further information on auto switches.

Type	Special function	Electrical entry	Indicator light	Wiring (Output)	Load voltage		Auto switch model		Lead wire length (m)				Pre-wired connector	Applicable load					
					DC	AC	Perpendicular	In-line	0.5 (NII)	1 (M)	3 (L)	5 (Z)			None (N)				
Solid state auto switch	—	Grommet	No	3-wire (NPN)	5 V, 12 V	—	M9NV	M9N	●	●	●	○	—	○	IC circuit				
				3-wire (PNP)			M9PV	M9P	●	●	●	○	—	○					
		Connector		2-wire	12 V	—	M9BV	M9B	●	●	●	○	—	○		—			
				Terminal conduit			2-wire	—	H7C	●	●	●	●	—			—		
		Diagnostic indication (2-color indicator)		Grommet	Yes	3-wire (NPN)	24 V	5 V, 12 V	—	—	G39A**	—	—	—		●	—	—	IC circuit
						3-wire (PNP)				—	K39A**	—	—	—		●	—	—	
	Water resistant (2-color indicator)	Grommet	No	3-wire (NPN)	5 V, 12 V	—	—	M9NVV	M9NV	●	●	●	○	—	○	IC circuit			
				3-wire (PNP)				M9PVV	M9PV	●	●	●	○	—	○				
	With diagnostic output (2-color indicator)	Grommet	No	2-wire	12 V	—	—	M9BVV	M9BV	●	●	●	○	—	○	—			
				3-wire (NPN)				M9NAV*1	M9NA*1	○	○	○	○	○	○		○	IC circuit	
—	Grommet	No	3-wire (PNP)	5 V, 12 V	—	—	M9PAV*1	M9PA*1	○	○	○	○	○	○	IC circuit				
			2-wire				—	M9BAV*1	M9BA*1	○	○	○	○	○		○			
Reed auto switch	—	Grommet	Yes	3-wire (NPN equivalent)	5 V	—	A96V	A96	●	●	●	—	—	—	IC circuit	—			
				2-wire			100 V	A93V*2	A93	●	●	●	●	—	—				
		Connector		No	100 V or less	24 V	12 V	—	—	A90V	A90	●	●	●	●	—	—	IC circuit	
					100 V, 200 V					—	B54**	●	●	●	●	—	—		
		Terminal conduit		Yes	200 V or less	24 V or less	—	—	—	—	B64**	●	●	●	●	—	—	—	
					24 V or less					—	C73C	●	●	●	●	●	—		—
		DIN terminal		Yes	24 V or less	—	—	—	—	—	C80C	●	●	●	●	●	—	IC circuit	
					100 V, 200 V					—	A33A**	—	—	—	—	●	—	—	—
		Grommet		No	100 V, 200 V	—	—	—	—	—	A34A**	—	—	—	—	●	—	—	
					—					—	A44A**	—	—	—	—	●	—		—
—	Grommet	No	—	—	—	—	—	B59W	●	●	●	—	—	—	IC circuit				
			—				—	—	—	—	—	—	—	—		—			

\*1 Water resistant type auto switches can be mounted on the above models, but in such case SMC cannot guarantee water resistance.

\*2 Please contact SMC regarding water resistant types with the above model numbers.

\*2 1 m type lead wire is only applicable to D-A93.

\* Lead wire length symbols: 0.5 m .....NII (Example) M9NV  
 1 m .....M (Example) M9NVW  
 3 m .....L (Example) M9NWL  
 5 m .....Z (Example) M9NVZ  
 None .....N (Example) H7CN

\* Solid state auto switches marked with "○" are produced upon receipt of order.

\* Do not indicate suffix "N" for no lead wire on the D-A93□/A44A/G39A/K39A models.

\*† D-A93□/A44A/G39A/K39A/B54/B64 cannot be mounted on bore sizes ø20 and ø25 cylinder with air cushion.

\* Since there are other applicable auto switches than listed above, refer to page 266 for details.

\* For details about auto switches with pre-wired connector, refer to pages 1648 and 1649.

\* The D-A9□□/M9□□□ auto switches are shipped together, (but not assembled). (However, only the auto switch mounting brackets are assembled before shipment.)



CJ1

CJP

CJ2

JCM

CM2

CM3

CG1

CG3

JMB

MB

MB1

CA2

CS1

CS2

D-□

-X□

Technical Data

# CM2R Series

**The CM2R direct mount cylinder can be installed directly through the use of a square rod cover.**

**Space saving has been realized.** Because it is a directly mounted type without using brackets, its overall length is shorter, and its installation pitch can be made smaller. Thus, the space that is required for installation has been dramatically reduced.

**Improved installation accuracy and strength**

A centering boss has been provided to improve the installation accuracy. Also, because it is the directly mounted type, the strength has been increased.

**Two types of installation**

Two types of installations are available and can be selected according to the purpose: the front mounting type or the bottom mounting type.

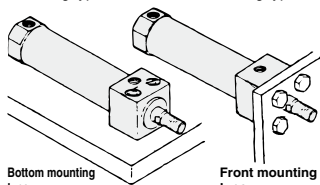

**Symbol**

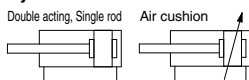

**Made to Order: Individual Specifications**  
(For details, refer to page 267.)

Symbol	Specifications
-X446	PTFE grease

**Made to Order**

[Click here for details](#)

Symbol	Specifications
-XA□	Change of rod end shape
-XB6	Heat resistant cylinder (-10 to 150°C)
-XB7	Cold resistant cylinder (-40 to 70°C)*1
-XB9	Low speed cylinder (10 to 50 mm/s)*1
-XC3	Special port location
-XC5	Heat resistant cylinder (-10 to 110°C)
-XC6	Made of stainless steel
-XC8	Adjustable stroke cylinder/Adjustable extension type*1
-XC9	Adjustable stroke cylinder/Adjustable retraction type*1
-XC11	Dual stroke cylinder/Single rod type
-XC13	Auto switch rail mounting
-XC20	Head cover axial port*1
-XC22	Fluororubber seal
-XC25	No fixed throttle of connection port*1
-XC29	Double knuckle joint with spring pin
-XC85	Grease for food processing equipment

\*1 Rubber bumper only.

Refer to pages 262 to 266 for cylinders with auto switches.

- Auto switch proper mounting position (detection at stroke end) and its mounting height
- Minimum stroke for auto switch mounting
- Operating range
- Auto switch mounting brackets/Part no.

## Specifications

Bore size (mm)		20	25	32	40	
<b>Action</b>		Double acting, Single rod				
<b>Fluid</b>		Air				
<b>Proof pressure</b>		1.5 MPa				
<b>Maximum operating pressure</b>		1.0 MPa				
<b>Minimum operating pressure</b>		0.05 MPa				
<b>Ambient and fluid temperature</b>		Without auto switch: -10°C to 70°C With auto switch: -10°C to 60°C (No freezing)				
<b>Lubrication</b>		Not required (Non-lube)				
<b>Stroke length tolerance</b>		+1.4 0 mm				
<b>Piston speed</b>		Rubber bumper: 50 to 750 mm/s, Air cushion: 50 to 1000 mm/s				
<b>Cushion</b>		Rubber bumper, Air cushion				
<b>Allowable kinetic energy</b>	<b>Rubber bumper</b>	Male thread	0.27 J	0.4 J	0.65 J	1.2 J
		Female thread	0.11 J	0.18 J	0.29 J	0.52 J
	<b>Air cushion (Effective cushion length (mm))</b>	Male thread	0.54 J (11.0)	0.78 J (11.0)	1.27 J (11.0)	2.35 J (11.8)
		Female thread	0.11 J	0.18 J	0.29 J	0.52 J

## Standard Strokes

Bore size (mm)	Standard stroke (mm) <small>Note 1)</small>	Max. manufacturable stroke (mm)
20	25, 50, 75, 100, 125, 150	1000
25	25, 50, 75, 100, 125, 150, 200	
32	25, 50, 75, 100, 125, 150, 200	
40	25, 50, 75, 100, 125, 150, 200, 250, 300	

Note 1) Other intermediate strokes can be manufactured upon receipt of order. Manufacture of intermediate strokes at 1 mm intervals is possible. (Spacers are not used.)

Note 2) Applicable strokes should be confirmed according to the usage. For details, refer to "Air Cylinders Model Selection" on front matter pages. In addition, the products that exceed the standard stroke might not be able to fulfill the specifications due to the deflection etc.

Note 3) Refer to the next page for Precautions.

**Tightening Torque:** Tighten the cylinder mounting bolts for the bottom mounting type (CM2RA series) with the following tightening torque.

Bore size (mm)	Hexagon socket head cap screw size	Tightening torque (N·m)
20	M5 x 0.8	2.4 to 3.6
25	M6	4.2 to 6.2
32	M8	10.0 to 15.0
40	M10	19.6 to 29.4

## Option: Ordering Example of Cylinder Assembly

**Cylinder model: CDM2RA20-100Z-V-M9BW**

**Mounting A: Bottom mounting type**  
**Rod end bracket V: Single knuckle joint**  
**Auto switch D-M9BW: 2 pcs.**

\* Single knuckle joint and auto switch are shipped together with the product, but not assembled.

\* No bracket is provided for the female rod end.

## Accessories

Accessories	Standard	Option	
	Rod end nut	Single knuckle joint	Double knuckle joint (with pin) <sup>*1</sup>
Mounting			
Bottom mounting type	●	●	●
Front mounting type	●	●	●

- \*1 A knuckle pin and retaining rings (split pin for ø40) are shipped together.  
 \*2 For dimensions and part numbers of options, refer to pages 189 and 190.  
 \*3 Stainless steel accessories are also available. Refer to page 190 for details.

## Weights

Bore size (mm)		(kg)			
		20	25	32	40
Basic weight	Bottom mounting type	0.14	0.23	0.32	0.62
	Front mounting type	0.14	0.22	0.32	0.61
Additional weight per 50 mm of stroke		0.04	0.06	0.08	0.13
Weight reduction for female rod end		-0.01	-0.02	-0.02	-0.04

Calculation:  
 (Example) **CM2RA32-100Z**  
 (ø32, 100 stroke, Bottom mounting)  
 • Basic weight.....0.32 kg  
 • Additional weight.....0.08 kg  
 • Cylinder stroke.....100 stroke  
 0.32 + 0.08 x 100/50 = **0.48 kg**

## ⚠ Precautions

**Be sure to read this before handling the products. Refer to back page 50 for Safety Instructions and pages 3 to 12 for Actuator and Auto Switch Precautions.**

### Handling

#### ⚠ Warning

- Do not rotate the cover.**  
If a cover is rotated when installing a cylinder or screwing a fitting into the port, it is likely to damage the junction part with cover.
- Do not operate with the cushion needle in a fully closed condition.**  
Using it in the fully closed state will cause the cushion seal to be damaged. When adjusting the cushion needle, use the "Hexagon wrench key: nominal size 1.5".
- Do not open the cushion needle wide excessively.**  
If the cushion needle were set to be completely wide (more than 3 turns from fully closed), it would be equivalent to the cylinder with no cushion, thus making the impacts extremely high. Do not use it in such a way. Besides, using with fully open could give damage to the piston or cover.
- Do not open the cushion needle after rotating it numerous times in a row.**  
Though uncommon, there are cases in which the cushion needle may leak air.  
The cushion needle should be adjusted by gradually opening it while checking the operation of the cylinder cushion. In the unlikely event that air leakage occurs, return the cushion needle to the fully-closed state, and readjust the cushion needle to the desired position.
- In the case of exceeding the standard stroke length, implement an intermediate support.**  
When using cylinder with longer stroke, implement an intermediate support for preventing the joint of rod cover and cylinder tube from being broken by vibration or external load.
- Operate the cylinder within the specified cylinder speed, kinetic energy and lateral load at the rod end.**
- The allowable kinetic energy is different between the cylinders with male rod end and with female rod end due to the different thread sizes.**
- When female rod end is used, use a washer, etc. to prevent the contact part at the rod end from being deformed depending on the material of the workpiece.**
- Do not apply excessive lateral load to the piston rod.**

Easy checking method

Minimum operating pressure after the cylinder is mounted to the equipment (MPa) = Minimum operating pressure of cylinder (MPa) + {Load mass (kg) x Friction coefficient of guide/Sectional area of cylinder (mm<sup>2</sup>)}

If smooth operation is confirmed within the above value, the load on the cylinder is the resistance of the thrust only and it can be judged as having no lateral load.

#### ⚠ Caution

- Not able to disassemble.**  
Cover and cylinder tube are connected to each other by caulking method, thus making it impossible to disassemble. Therefore, internal parts of a cylinder other than rod seal are not replaceable.
- Use caution to the popping of a retaining ring.**  
When replacing rod seals and removing and mounting a retaining ring, use a proper tool (retaining ring plier: tool for installing a type C retaining ring). Even if a proper tool is used, it is likely to inflict damage to a human body or peripheral equipment, as a retaining ring may be flown out of the tip of a plier. Be much careful with the popping of a retaining ring. Besides, be certain that a retaining ring is placed firmly into the groove of rod cover before supplying air at the time of installment.
- Do not touch the cylinder during operation.**  
Use caution when handling a cylinder, which is running at a high speed and a high frequency, because the surface of a cylinder tube could get so hot enough as to cause you get burned.
- Do not use the air cylinder as an air-hydro cylinder.**  
If it uses turbine oil in place of fluids for cylinder, it may result in oil leak.
- The oil stuck to the cylinder is grease.**
- The base oil of grease may seep out.**
- When using a rod end bracket, make sure it does not interfere with other brackets, workpieces and rod section, etc.**

# CM2R Series

## Clean Series

10-CM2R Mounting type Bore size – Stroke Z

• Clean Series (With relief port)

The type which is applicable for using inside the clean room graded ISO Class 4 by making an actuator's rod section a double seal construction and discharging by relief port directly to the outside of clean room.



### Specifications

<b>Action</b>	Double acting, Single rod
<b>Bore size (mm)</b>	ø20, ø25, ø32, ø40
<b>Max. operating pressure</b>	1.0 MPa
<b>Min. operating pressure</b>	0.05 MPa
<b>Cushion</b>	Rubber bumper (Standard equipment)
<b>Relief port size</b>	M5 x 0.8
<b>Piston speed</b>	30 to 400 mm/s
<b>Mounting</b>	Bottom mounting type, Front mounting type

\* Auto switch can be mounted.

### Construction

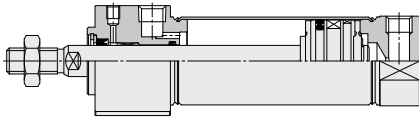

(mm)	
Bore size (mm)	GC
20	6
25	6
32	7
40	9

#### Front mounting type

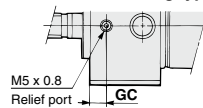

#### Bottom mounting type

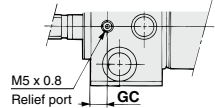

For detailed specifications about the clean series, refer to the "Pneumatic Clean Series" (CAT.E02-23).

## Air-hydro

CM2HR Mounting type Bore size – Stroke Z – Made to Order

• Air-hydro

A low hydraulic pressure cylinder used at a pressures of 1.0 MPa or below.

Through the concurrent use of the CC series air-hydro unit, it is possible to operate at a constant or low speeds or to effect an intermediate stop, just like a hydraulic unit, while using pneumatic equipment such as a valve.



### Specifications

<b>Type</b>	Air-hydro
<b>Fluid</b>	Turbine oil
<b>Action</b>	Double acting, Single rod
<b>Bore size (mm)</b>	ø20, ø25, ø32, ø40
<b>Proof pressure</b>	1.5 MPa
<b>Max. operating pressure</b>	1.0 MPa
<b>Min. operating pressure</b>	0.18 MPa
<b>Piston speed</b>	15 to 300 mm/s
<b>Cushion</b>	Rubber bumper
<b>Ambient and fluid temperature</b>	+5 to +60°C
<b>Stroke length tolerance</b>	$^{+1.4}_0$ mm
<b>Mounting</b>	Bottom mounting type, Front mounting type
<b>Made to Order**</b>	<b>-XC3</b> Special port location

\* Auto switch can be mounted. Dimensions are the same as the standard type.

\*\* For details, refer to pages 1703 to 1896.

- For construction, refer to page 239.
- Since the dimensions of mounting type are the same as pages 240 and 241, refer to those pages.

## Construction

### Rubber bumper

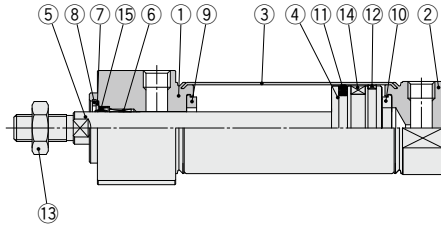

### Air-hydro

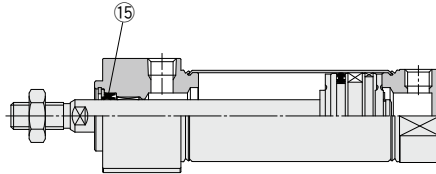

### With air cushion

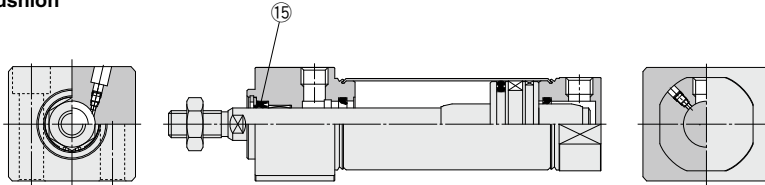

## Component Parts

No.	Description	Material	Note
1	Rod cover	Aluminum alloy	Anodized
2	Head cover	Aluminum alloy	Anodized
3	Cylinder tube	Stainless steel	
4	Piston	Aluminum alloy	
5	Piston rod	Carbon steel	Hard chrome plating
6	Bushing	Bearing alloy	
7	Seal retainer	Stainless steel	
8	Retaining ring	Carbon steel	Phosphate coating
9	Bumper	Resin	ø25 or larger is common.
10	Bumper	Resin	
11	Piston seal	NBR	
12	Wear ring	Resin	
13	Rod end nut	Carbon steel	Zinc chromated
14	Magnet	—	CDM2R□20 to 40-□Z
15	Rod seal	NBR	

For auto switch proper mounting position (at stroke end), refer to pages 263 and 265, since the operating range is the same as standard type, single rod.

## Replacement Part: Seal

### ● With Rubber Bumper/With Air Cushion

No.	Description	Material	Part no.			
			20	25	32	40
15	Rod seal	NBR	CM20Z-PS	CM25Z-PS	CM32Z-PS	CM40Z-PS

### ● Air-hydro

No.	Description	Material	Part no.			
			20	25	32	40
15	Rod seal	NBR	CM2H20-PS	CM2H25-PS	CM2H32-PS	CM2H40-PS

\* Since the seal does not include a grease pack, order it separately.

**Grease pack part number: GR-S-010 (10 g)**

CJ1

CJP

CJ2

JCM

**CM2**

CM3

CG1

CG3

JMB

MB

MB1

CA2

CS1

CS2

D-□

-X□

Technical Data

# CM2R Series

## Bottom Mounting Type

CM2RA Bore size – Stroke Z

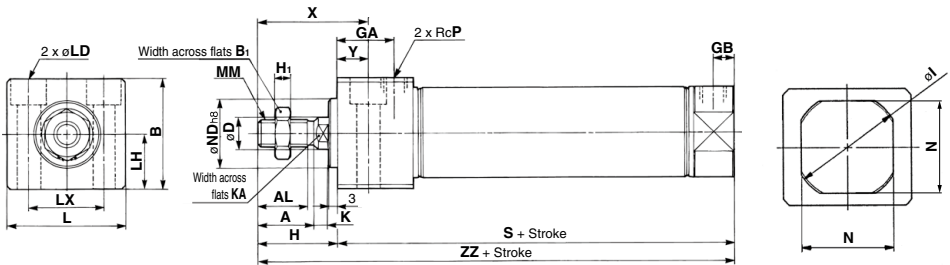

### With air cushion

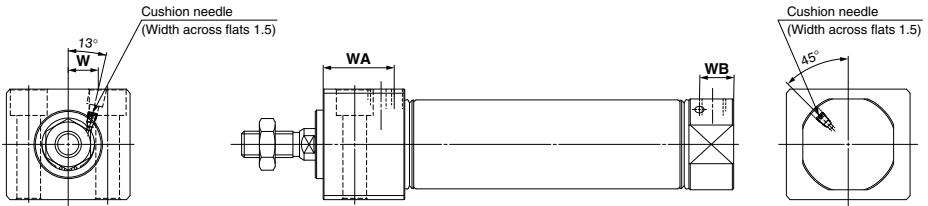

### Female rod end

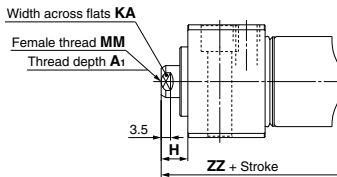

Bore size	Stroke range	A	AL	B	B1	D	GA	GB	H	H1	I	K	KA	L	LD	LH	LX	MM	N	ND	P	S	X	Y	ZZ
20	1 to 150	18	15.5	30.3	13	8	22	8	27	5	28	5	6	33.5	ø5.5, ø9.5 counterbore depth 6.5	15	21	M8 x 1.25	24	20 <sup>0</sup> <sub>0.033</sub>	1/8	76	39	12	103
25	1 to 200	22	19.5	36.3	17	10	22	8	31	6	33.5	5.5	8	39	ø6.8, ø11 counterbore depth 7.5	18	25	M10 x 1.25	30	26 <sup>0</sup> <sub>0.033</sub>	1/8	76	43	12	107
32	1 to 200	22	19.5	42.3	17	12	22	8	31	6	37.5	5.5	10	47	ø9, ø14 counterbore depth 10	21	30	M10 x 1.25	34.5	26 <sup>0</sup> <sub>0.033</sub>	1/8	78	43	12	109
40	1 to 300	24	21	52.3	22	14	27	11	34	8	46.5	7	12	58.5	ø11, ø17.5 counterbore depth 12.5	26	38	M14 x 1.5	42.5	32 <sup>0</sup> <sub>0.039</sub>	1/4	104	49	15	138

### With Air Cushion (mm)

Bore size	WA	WB	W
20	27	13	8.5
25	27	13	10.5
32	27	13	11.5
40	32	16	15

### Female Rod End (mm)

Bore size	A1	H	KA	MM	ZZ
20	8	10	6	M4 x 0.7	86
25	8	10	8	M5 x 0.8	86
32	12	10	10	M6 x 1	88
40	13	10	12	M8 x 1.25	114

- \* When female thread is used, use a thin wrench when tightening the piston rod.
- \* When female thread is used, use a washer etc. to prevent the contact part at the rod end from being deformed depending on the material of the workpiece.

### Front Mounting Type

CM2RB Bore size – Stroke Z

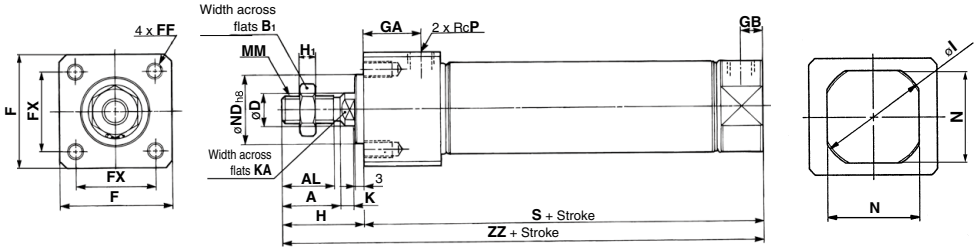

### With air cushion

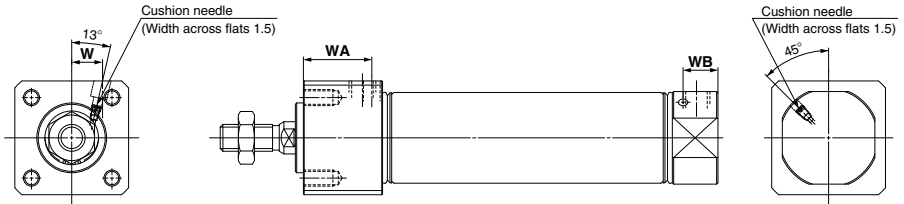

### Female rod end

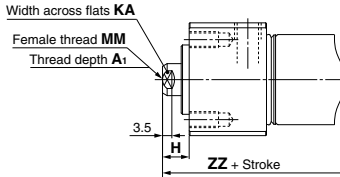

Bore size	Stroke range	A	AL	B <sub>1</sub>	D	F	FF	FX	GA	GB	H	H <sub>1</sub>	I	K	KA	MM	N	ND	P	S	ZZ
20	1 to 150	18	15.5	13	8	30.4	M5 x 0.8 depth 9	22	22	8	27	5	28	5	6	M8 x 1.25	24	20 <sup>0</sup> <sub>-0.033</sub>	1/8	76	103
25	1 to 200	22	19.5	17	10	36.4	M6 x 1 depth 11	26	22	8	31	6	33.5	5.5	8	M10 x 1.25	30	26 <sup>0</sup> <sub>-0.033</sub>	1/8	76	107
32	1 to 200	22	19.5	17	12	42.4	M6 x 1 depth 11	30	22	8	31	6	37.5	5.5	10	M10 x 1.25	34.5	26 <sup>0</sup> <sub>-0.033</sub>	1/8	78	109
40	1 to 300	24	21	22	14	52.4	M8 x 1.25 depth 14	36	27	11	34	8	46.5	7	12	M14 x 1.5	42.5	32 <sup>0</sup> <sub>-0.039</sub>	1/4	104	138

**With Air Cushion** (mm)

Bore size	WA	WB	W
20	27	13	8.5
25	27	13	10.5
32	27	13	11.5
40	32	16	15

**Female Rod End** (mm)

Bore size	A <sub>1</sub>	H	KA	MM	ZZ
20	8	10	6	M4 x 0.7	86
25	8	10	8	M5 x 0.8	86
32	12	10	10	M6 x 1	88
40	13	10	12	M8 x 1.25	114

- \* When female thread is used, use a thin wrench when tightening the piston rod.
- \* When female thread is used, use a washer etc. to prevent the contact part at the rod end from being deformed depending on the material of the workpiece.

- CJ1
- CJP
- CJ2
- JCM
- CM2
- CM3
- CG1
- CG3
- JMB
- MB
- MB1
- CA2
- CS1
- CS2

- D-□
- X□
- Technical Data

# Air Cylinder: Direct Mount, Non-rotating Rod Type Double Acting, Single Rod

## CM2RK Series

ø20, ø25, ø32, ø40

RoHS



### How to Order

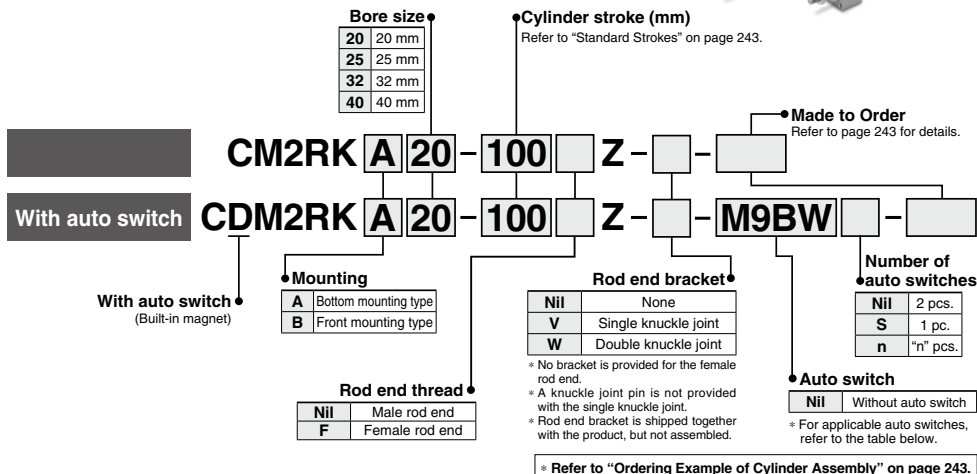

\* Refer to "Ordering Example of Cylinder Assembly" on page 243.

### Applicable Auto Switches/Refer to pages 1575 to 1701 for further information on auto switches.

Type	Special function	Electrical entry	Indicator light	Wiring (Output)	Load voltage		Auto switch model		Lead wire length (m)					Pre-wired connector	Applicable load					
					DC	AC	Perpendicular	In-line	0.5	1	3	5	None (N)							
									(Nil)	(M)	(L)	(Z)								
Solid state auto switch	—	Grommet	Yes	3-wire (NPN)	5 V, 12 V	—	M9NV	M9N	●	●	●	●	—	—	—	IC circuit	Relay, PLC			
				3-wire (PNP)			M9PV	M9P	●	●	●	●	—	—						
		Connector		2-wire	M9BV	M9B	●	●	●	●	—	—	—	—	—					
				Terminal conduit	—	H7C	●	—	—	—	—	—	—	—	—			—		
		Diagnostic indication (2-color indicator)		Grommet	3-wire (NPN)	24 V	5 V, 12 V	—	—	G39A	—	—	—	—	—			—	—	—
					3-wire (PNP)				—	K39A	—	—	—	—	—			—	—	—
	Water resistant (2-color indicator)	Grommet	Yes	2-wire	12 V	—	M9NVV	M9NV	●	●	●	●	—	—	—	—				
				3-wire (NPN)			M9PWV	M9PW	●	●	●	●	—	—	—	—				
				3-wire (PNP)	M9BVV	M9BV	●	●	●	●	—	—	—	—	—					
				2-wire	M9NAV <sup>*1</sup>	M9NA <sup>*1</sup>	○	○	○	○	—	—	—	—	—					
				3-wire (NPN)	M9PAV <sup>*1</sup>	M9PA <sup>*1</sup>	○	○	○	○	—	—	—	—	—					
				3-wire (PNP)	M9BAV <sup>*1</sup>	M9BA <sup>*1</sup>	○	○	○	○	—	—	—	—	—					
Reed auto switch	—	Grommet	Yes	3-wire (NPN equivalent)	24 V	12 V	—	A96V	A96	●	●	—	—	—	—	—	—			
								Connector	100 V	A93V <sup>*2</sup>	A93	●	●	●	—	—	—	—	—	
									100 V or less	A90V	A90	●	●	●	—	—	—	—	—	
									100 V, 200 V	—	B54	●	—	●	—	—	—	—	—	
									200 V or less	—	B64	●	—	●	—	—	—	—	—	
								Terminal conduit	24 V or less	—	C73C	●	—	●	—	—	—	—	—	—
		—		—	C80C	●	—		●	—	—	—	—	—	—					
		DIN terminal		—	—	—	—	—	—	A33A	—	—	—	—	—	—	—	—		
				—	—	—	—	—	—	A34A	—	—	—	—	—	—	—	—		
		Grommet		100 V, 200 V	—	—	—	—	—	A44A	—	—	—	—	—	—	—	—		
				—	—	—	—	—	—	B59W	●	—	●	—	—	—	—	—		

\*1 Water resistant type auto switches can be mounted on the above models, but in such case SMC cannot guarantee water resistance.

\*2 Please contact SMC regarding water resistant types with the above model numbers.

\*3 2 1 m type lead wire is only applicable to D-A93.

\* Lead wire length symbols: 0.5 m ..... Nil (Example) M9NW  
1 m ..... M (Example) M9NWW  
3 m ..... L (Example) M9NWL  
5 m ..... Z (Example) M9NZZ  
None ..... N (Example) H7CN

\* Solid state auto switches marked with "○" are produced upon receipt of order.  
\* Do not indicate suffix "N" for no lead wire on D-A3□□/A44□/G39A/K39A models.

\* Since there are other applicable auto switches than listed above, refer to page 266 for details.

\* For details about auto switches with pre-wired connector, refer to pages 1648 and 1649.

\* The D-A9□□/M9□□□ auto switches are shipped together, (but not assembled). (However, only the auto switch mounting brackets are assembled before shipment.)



The CM2RK direct mount cylinder can be installed directly through the use of a square rod cover.

### Non-rotating accuracy

A cylinder which the rod does not rotate because of its hexagonal shape.

$\phi 20, \phi 25 — \pm 0.7^\circ$   
 $\phi 32, \phi 40 — \pm 0.5^\circ$

**Space-saving has been realized.**  
 Because it is a directly mounted type without using brackets, its overall length is shorter, and its installation pitch can be made smaller. Thus, the space that is required for installation has been dramatically reduced.

### Improved installation accuracy and strength

A centering boss has been provided to improve the installation accuracy. Also, because it is the directly mounted type, the strength has been increased.

### Two types of installation

Two types of installations are available and can be selected according to the purpose: the front mounting type or the bottom mounting type.

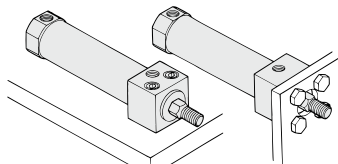

Bottom mounting type

Front mounting type

### Symbol

Rubber bumper

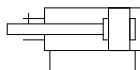

**Made to Order**  
[Click here for details](#)

Symbol	Specifications
-XA□	Change of rod end shape
-XB6	Heat resistant cylinder (-10 to 150°C)
-XC3	Special port location
-XC6	Made of stainless steel
-XC8	Adjustable stroke cylinder/Adjustable extension type
-XC9	Adjustable stroke cylinder/Adjustable retraction type
-XC11	Dual stroke cylinder/Single rod type
-XC13	Auto switch rail mounting
-XC20	Head cover axial port
-XC22	Fluororubber seal
-XC25	No fixed throttle of connection port
-XC85	Grease for food processing equipment
-X446	PTFE grease

### Accessories

Refer to pages 189 and 190 for accessories, since it is the same as standard type, double acting, single rod.

## Specifications

Bore size (mm)		20	25	32	40
Rod non-rotating accuracy		± 0.7°		± 0.5°	
Action		Double acting, Single rod			
Fluid		Air			
Proof pressure		1.5 MPa			
Maximum operating pressure		1.0 MPa			
Minimum operating pressure		0.05 MPa			
Ambient and fluid temperature		Without auto switch: -10°C to 70°C With auto switch: -10°C to 60°C (No freezing)			
Lubrication		Not required (Non-lube)			
Stroke length tolerance		+1.4 0 mm			
Piston speed		50 to 500 mm/s			
Cushion		Rubber bumper			
Allowable kinetic energy	Male thread	0.27 J	0.4 J	0.65 J	1.2 J
	Female thread	0.11 J	0.18 J	0.29 J	0.52 J

## Standard Strokes

Bore size (mm)	Standard stroke (mm) <sup>Note 1)</sup>	Max. manufacturable stroke (mm)
20	25, 50, 75, 100, 125, 150	1000
25	25, 50, 75, 100, 125, 150, 200	
32	25, 50, 75, 100, 125, 150, 200	
40	25, 50, 75, 100, 125, 150, 200, 250, 300	

Note 1) Other intermediate strokes can be manufactured upon receipt of order. Manufacture of intermediate strokes at 1 mm intervals is possible. (Spacers are not used.)

Note 2) Applicable strokes should be confirmed according to the usage. For details, refer to "Air Cylinders Model Selection" on front matter pages. In addition, the products that exceed the standard stroke might not be able to fulfill the specifications due to the deflection etc.

**Tightening Torque:** Tighten the cylinder mounting bolts for the bottom mounting type (CM2RKA series) with the following tightening torque.

Bore size (mm)	Hexagon socket head cap bolt size	Tightening torque (N·m)
20	M5 x 0.8	2.4 to 3.6
25	M6	4.2 to 6.2
32	M8	10.0 to 15.0
40	M10	19.6 to 29.4

## Option: Ordering Example of Cylinder Assembly

Cylinder model: CDM2RKA20-100Z-V-M9BW

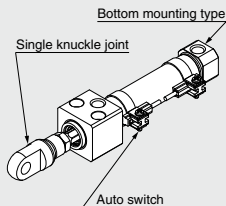

**Mounting A: Bottom mounting type**  
 Rod end bracket V: Single knuckle joint  
 Auto switch D-M9BW: 2 pcs.

\* Single knuckle joint and auto switch are shipped together with the product, but not assembled.

\* No bracket is provided for the female rod end.

Refer to pages 262 to 266 for cylinders with auto switches.

- Auto switch proper mounting position (detection at stroke end) and its mounting height
- Minimum stroke for auto switch mounting
- Operating range
- Auto switch mounting brackets/Part no.

CJ1

CJP

CJ2

JCM

CM2

CM3

CG1

CG3

JMB

MB

MB1

CA2

CS1

CS2

D-□

-X□

Technical Data

# CM2RK Series

## Accessories

Accessories	Standard	Option	
	Rod end nut	Single knuckle joint	Double knuckle joint (with pin) <sup>*1</sup>
Mounting			
Bottom mounting type	●	●	●
Front mounting type	●	●	●

\*1 A knuckle pin and retaining rings (split pin for ø40) are shipped together.

\*2 For dimensions and part numbers of options, refer to pages 189 and 190.

\*3 Stainless steel accessories are also available. Refer to page 190 for details.

## Weights

Bore size (mm)		(kg)			
		20	25	32	40
Basic weight	Bottom mounting type	0.14	0.23	0.32	0.62
	Front mounting type	0.14	0.22	0.32	0.61
Additional weight per 50 mm of stroke		0.04	0.06	0.08	0.13
Weight reduction for female rod end		-0.01	-0.02	-0.02	-0.04

Calculation:

(Example) **CM2RKA32-100Z**

(ø32, 100 stroke, Bottom mounting)

- Basic weight.....0.32 kg
- Additional weight.....0.08 kg
- Cylinder stroke.....100 stroke

$$0.32 + 0.08 \times 100/50 = 0.48 \text{ kg}$$

## ⚠ Precautions

Be sure to read this before handling the products. Refer to back page 50 for Safety Instructions and pages 3 to 12 for Actuator and Auto Switch Precautions.

### Handling/Disassembly

#### ⚠ Warning

##### 1. Do not rotate the cover.

If a cover is rotated when installing a cylinder or screwing a fitting into the port, it is likely to damage the junction part with cover.

##### 2. In the case of exceeding the standard stroke length, implement an intermediate support.

When using cylinder with longer stroke, implement an intermediate support for preventing the joint of rod cover and cylinder tube from being broken by vibration or external load.

#### ⚠ Caution

##### 1. Avoid using the air cylinder in such a way that rotational torque would be applied to the piston rod.

If rotational torque is applied, the non-rotating guide will become deformed, thus affecting the non-rotating accuracy.

Refer to the table below for the approximate values of the allowable range of rotational torque.

Allowable rotational torque (N·m or less)	ø20	ø25	ø32	ø40
	0.2	0.25	0.25	0.44

To screw a bracket or a nut onto the threaded portion at the tip of the piston rod, make sure to retract the piston rod entirely, and place a wrench over the flat portion of the rod that protrudes.

Tighten it by giving consideration to prevent the tightening torque from being applied to the non-rotating guide.

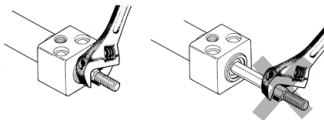

#### ⚠ Caution

##### 2. When replacing rod seals, please contact SMC.

Air leakage may be happened, depending on the position in which a rod seal is fitted. Thus, please contact SMC when replacing them.

##### 3. Not able to disassemble.

Cover and cylinder tube are connected to each other by caulking method, thus making it impossible to disassemble. Therefore, internal parts of a cylinder other than rod seal are not replaceable.

##### 4. Do not touch the cylinder during operation.

Use caution when handling a cylinder, which is running at a high speed and a high frequency, because the surface of a cylinder tube could get so hot enough as to cause you get burned.

##### 5. The oil stuck to the cylinder is grease.

##### 6. The base oil of grease may seep out.

##### 7. When using a rod end bracket, make sure it does not interfere with other brackets, workpieces and rod section, etc.

# Air Cylinder: Direct Mount, Non-rotating Rod Type Double Acting, Single Rod **CM2RK Series**

## Construction

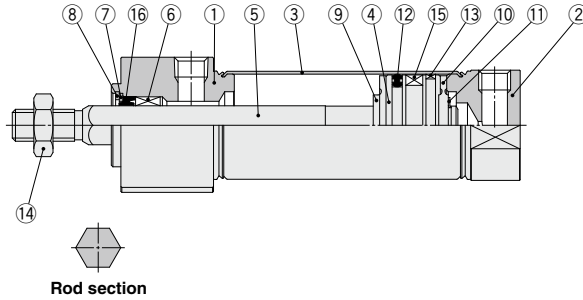

### Component Parts

No.	Description	Material	Note
1	<b>Rod cover</b>	Aluminum alloy	Anodized
2	<b>Head cover</b>	Aluminum alloy	Anodized
3	<b>Cylinder tube</b>	Stainless steel	
4	<b>Piston</b>	Aluminum alloy	
5	<b>Piston rod</b>	Stainless steel	
6	<b>Non-rotating guide</b>	Bearing alloy	
7	<b>Seal retainer</b>	Carbon steel	Nickel plating
8	<b>Retaining ring</b>	Carbon steel	Phosphate coating
9	<b>Bumper</b>	Resin	
10	<b>Bumper</b>	Resin	
11	<b>Retaining ring</b>	Stainless steel	
12	<b>Piston seal</b>	NBR	

No.	Description	Material	Note
13	<b>Wear ring</b>	Resin	
14	<b>Rod end nut</b>	Carbon steel	Zinc chromated
15	<b>Magnet</b>	—	CDM2RK□20 to 40-□Z
16	<b>Rod seal</b>	NBR	

### Replacement Part: Seal

No.	Description	Material	Part no.			
			20	25	32	40
16	<b>Rod seal</b>	NBR	CM2K20-PS	CM2K25-PS	CM2K32-PS	CM2K40-PS

\* Since the seal does not include a grease pack, order it separately.  
**Grease pack part number: GR-S-010 (10 g)**

- CJ1**
- CJP**
- CJ2**
- JCM**
- CM2**
- CM3**
- CG1**
- CG3**
- JMB**
- MB**
- MB1**
- CA2**
- CS1**
- CS2**

- D-□**
- X□**
- Technical Data



### Bottom Mounting Type

**CM2RKA** Bore size – Stroke Z

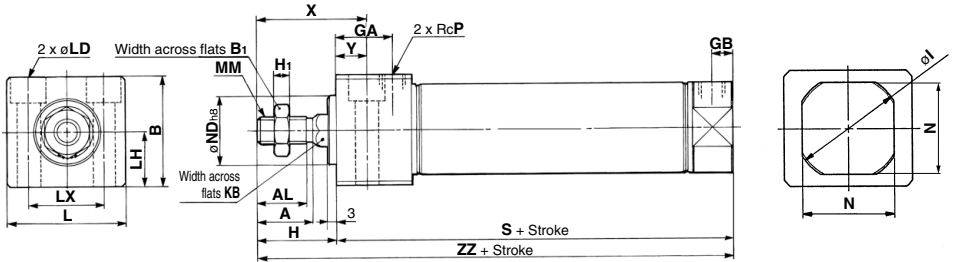

#### Female rod end

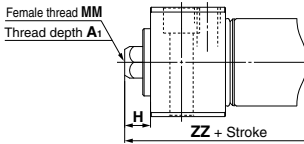

#### Female Rod End (mm)

Bore size	A <sub>1</sub>	H	MM	ZZ
20	8	10	M4 x 0.7	86
25	8	10	M5 x 0.8	86
32	12	10	M6 x 1	88
40	13	10	M8 x 1.25	114

\* When female thread is used, use a thin wrench when tightening the piston rod.

\* When female thread is used, use a washer etc. to prevent the contact part at the rod end from being deformed depending on the material of the workpiece.

Bore size	Stroke range	A	AL	B	B <sub>1</sub>	GA	GB	H	H <sub>1</sub>	I	KB	L	LD	LH	LX	MM	N	ND	P	S	X	Y	ZZ
20	1 to 150	18	15.5	30.3	13	22	8	27	5	28	8.2	33.5	ø5.5, ø9.5 counterbore depth 6.5	15	21	M8 x 1.25	24	20 <sup>±0.033</sup>	1/8	76	39	12	103
25	1 to 200	22	19.5	36.3	17	22	8	31	6	33.5	10.2	39	ø6.6, ø11 counterbore depth 7.5	18	25	M10 x 1.25	30	26 <sup>±0.033</sup>	1/8	76	43	12	107
32	1 to 200	22	19.5	42.3	17	22	8	31	6	37.5	12.2	47	ø9, ø14 counterbore depth 10	21	30	M10 x 1.25	34.5	26 <sup>±0.033</sup>	1/8	78	43	12	109
40	1 to 300	24	21	52.3	22	27	11	34	8	46.5	14.2	58.5	ø11, ø17.5 counterbore depth 12.5	26	38	M14 x 1.5	42.5	32 <sup>±0.039</sup>	1/4	104	49	15	138

### Front Mounting Type

**CM2RKB** Bore size – Stroke Z

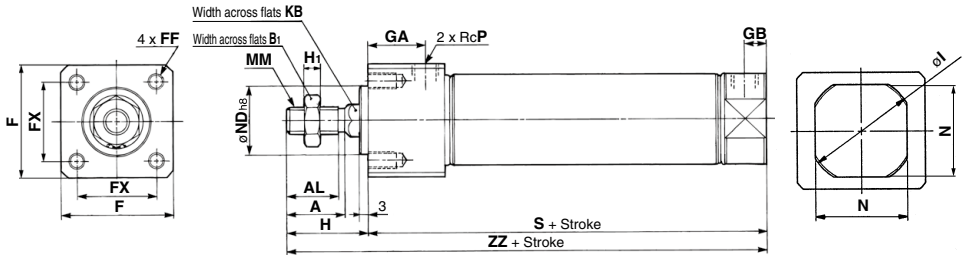

#### Female rod end

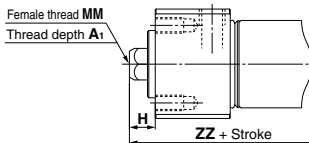

#### Female Rod End (mm)

Bore size	A <sub>1</sub>	H	MM	ZZ
20	8	10	M4 x 0.7	86
25	8	10	M5 x 0.8	86
32	12	10	M6 x 1	88
40	13	10	M8 x 1.25	114

\* When female thread is used, use a thin wrench when tightening the piston rod.

\* When female thread is used, use a washer etc. to prevent the contact part at the rod end from being deformed depending on the material of the workpiece.

Bore size	Stroke range	A	AL	B <sub>1</sub>	F	FF	FX	GA	GB	H	H <sub>1</sub>	I	KB	MM	N	ND	P	S	ZZ
20	1 to 150	18	15.5	13	30.4	M5 x 0.8 depth 9	22	22	8	27	5	28	8.2	M8 x 1.25	24	20 <sup>±0.033</sup>	1/8	76	103
25	1 to 200	22	19.5	17	36.4	M6 x 1 depth 11	26	22	8	31	6	33.5	10.2	M10 x 1.25	30	26 <sup>±0.033</sup>	1/8	76	107
32	1 to 200	22	19.5	17	42.4	M6 x 1 depth 11	30	22	8	31	6	37.5	12.2	M10 x 1.25	34.5	26 <sup>±0.033</sup>	1/8	78	109
40	1 to 300	24	21	22	52.4	M8 x 1.25 depth 14	36	27	11	34	8	46.5	14.2	M14 x 1.5	42.5	32 <sup>±0.039</sup>	1/4	104	138

□ CJ1

□ CJP

□ CJ2

□ JCM

□ CM2

□ CM3

□ CG1

□ CG3

□ JMB

□ MB

□ MB1

□ CA2

□ CS1

□ CS2

□ D-□

□ -X□

□ Technical Data

# Air Cylinder: Centralized Piping Type Double Acting, Single Rod

## CM2□P Series

ø20, ø25, ø32, ø40

### How to Order

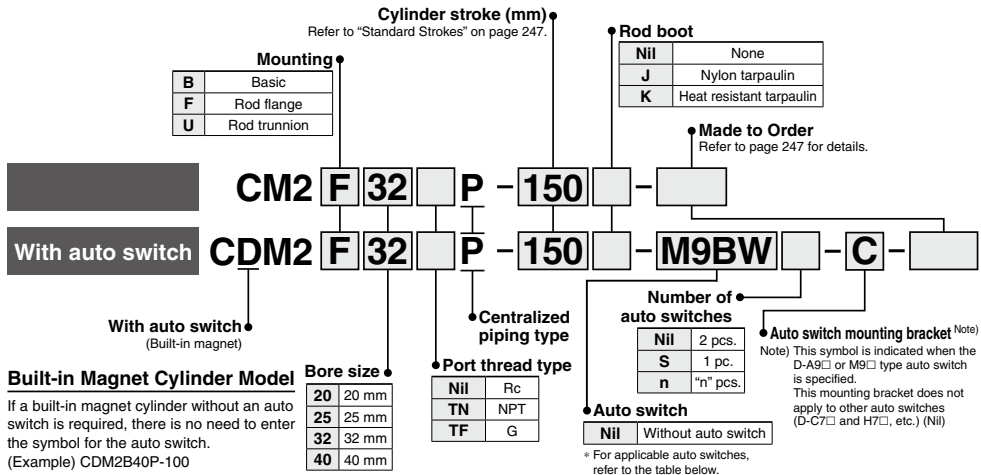

### Applicable Auto Switches/Refer to pages 1575 to 1701 for further information on auto switches.

Type	Special function	Electrical entry	Indicator light	Wiring (Output)	Load voltage		Auto switch model		Lead wire length (m)					Pre-wired connector	Applicable load											
					DC	AC	Perpendicular	In-line	0.5 (Nil)	1 (M)	3 (L)	5 (Z)	None (N)													
									24 V	5 V, 12 V	●	●	●			○	○									
Solid state auto switch	—	Grommet	No	3-wire (NPN)	24 V	5 V, 12 V	—	M9NV	M9N	●	●	●	○	○	IC circuit	Relay, PLC										
				3-wire (PNP)				M9PV	M9P	●	●	●	○	○												
				2-wire				M9BV	M9B	●	●	●	○	○												
		Connector		—				H7C	●	—	●	●	—	—			IC circuit									
		Terminal conduit		—				G39A	—	—	—	—	●	—												
		—		—				K39A	—	—	—	—	●	—												
	Diagnostic indication (2-color indicator)	Grommet	Yes	3-wire (NPN)	24 V	5 V, 12 V	—	M9NVV	M9NV	●	●	●	○	○	IC circuit											
				3-wire (PNP)				M9PWW	M9PW	●	●	●	○	○												
				2-wire				M9BWW	M9BW	●	●	●	○	○												
	Water resistant (2-color indicator)	Grommet	No	3-wire (NPN)	24 V	5 V, 12 V	—	M9NAV <sup>*1</sup>	M9NA <sup>*1</sup>	○	○	○	○	○	IC circuit											
				3-wire (PNP)				M9PAV <sup>*1</sup>	M9PA <sup>*1</sup>	○	○	○	○	○												
				2-wire				M9BAV <sup>*1</sup>	M9BA <sup>*1</sup>	○	○	○	○	○												
With diagnostic output (2-color indicator)	Grommet	Yes	4-wire (NPN)	24 V	5 V, 12 V	—	—	H7NF	●	—	●	○	○	IC circuit												
			—				Grommet	Yes	3-wire (NPN equivalent)	24 V	12 V	—	A96V		A96	●	●	—	IC circuit							
													—		A93V <sup>*2</sup>	A93	●	●		●	—					
Reed auto switch	—	Grommet	No/Yes/No	2-wire	24 V	12 V	—	—	A90V	A90	●	—	—	—	IC circuit											
								—	—	B54	●	—	●	—		—										
								—	—	B64	●	—	●	—			—									
								—	—	—	—	C73C	●	—		●		—	IC circuit							
		Connector		No/Yes/No				2-wire	24 V	12 V	—	—	—	C80C	●	—	●	—		IC circuit						
													Terminal conduit	Yes	2-wire	24 V	12 V	—	—		A33A	—	—	●	PLC	
																			—		—	A34A	—	—		●
																			—		—	A44A	—	—		●
DIN terminal	Yes	2-wire	24 V	12 V	—	—	—	A44A	—	—	●	Relay, PLC														
							—	—	B59W	●	—		●													

\*1 Water resistant type auto switches can be mounted on the above models, but in such case SMC cannot guarantee water resistance.

\*2 Please contact SMC regarding water resistant types with the above model numbers.

\*3 2.1 m type lead wire is only applicable to D-A93.

\*4 Lead wire length symbols: 0.5 m ..... Nil (Example) M9NV  
1 m ..... M (Example) M9NVW  
3 m ..... L (Example) M9NWL  
5 m ..... Z (Example) M9NWZ  
None ..... N (Example) H7CN

\*5 Central state auto switches marked with "○" are produced upon receipt of order.

\*6 Since there are other applicable auto switches than listed above, refer to page 266 for details.

\*7 For details about auto switches with pre-wired connector, refer to pages 1648 and 1649.

\*8 The D-A9□/M9□□□ auto switches are shipped together, (but not assembled). (However, only the auto switch mounting brackets are assembled before shipment.)

A cylinder in which two piping ports are provided in the head cover, enabling pipes to be connected only in the axial direction.



### Symbol

Double acting, Single rod, Rubber bumper

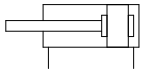

**Made to Order**  
[Click here for details](#)

Symbol	Specifications
-XA□	Change of rod end shape
-XC4	With heavy duty scraper
-XC6	Made of stainless steel
-XC29	Double knuckle joint with spring pin
-XC52	Mounting nut with set screw
-XC85	Grease for food processing equipment

### ⚠ Precautions

**Be sure to read this before handling the products. Refer to back page 50 for Safety Instructions and pages 3 to 12 for Actuator and Auto Switch Precautions.**

## Specifications

Bore size (mm)	20	25	32	40
Action	Double acting, Single rod			
Fluid	Air			
Proof pressure	1.5 MPa			
Maximum operating pressure	1.0 MPa			
Minimum operating pressure	0.05 MPa			
Ambient and fluid temperature	Without auto switch: -10°C to 70°C (No freezing) With auto switch: -10°C to 60°C			
Lubrication	Not required (Non-lube)			
Stroke length tolerance	$^{+1.4}_0$ mm			
Cushion	Rubber bumper			
Piston speed	50 to 700 mm/s	50 to 650 mm/s	50 to 590 mm/s	50 to 420 mm/s
Allowable kinetic energy	0.27 J	0.4 J	0.65 J	1.2 J

## Standard Strokes

Bore size (mm)	Standard stroke (mm) <sup>Note 1)</sup>	Maximum manufacturable stroke (mm) <sup>Note 2)</sup>
20	25, 50, 75, 100, 125, 150 200, 250, 300	1000
25		
32		
40		

Note 1) Other intermediate strokes can be manufactured upon receipt of order.

Manufacture of intermediate strokes at 1 mm intervals is possible. (Spacers are not used.)

Note 2) When exceeding 300 strokes, refer to "Air Cylinders Model Selection" on front matter pages.

## Mounting and Accessories

Accessories	Standard		Option			
	Mounting nut	Rod end nut	Single knuckle joint	Double knuckle joint (with pin)	Rod boot	Pivot bracket
Basic	● (1 pc.)	●	●	●	●	—
Rod flange	● (1 pc.)	●	●	●	●	—
Rod trunnion	● (1 pc.)	●	●	●	●	●

\*1 A pin and retaining rings (split pins for ø40) are shipped together with double knuckle joint.

\*2 For dimensions and part numbers of options, refer to pages 189 to 191.

\*3 Stainless steel mounting brackets and accessories are also available.

Refer to page 190 for details.

## Mounting Brackets/Part No.

Mounting bracket	Min. order qty	Bore size (mm)			Contents (for minimum order quantity)
		20	25	32	
Flange	1	CM-F020B	CM-F032B	CM-F040B	1 flange
Trunnion (with nut)	1	CM-T020B	CM-T032B	CM-T040B	1 trunnion, 1 trunnion nut

\* Order 2 feet per cylinder.

Refer to pages 262 to 266 for cylinders with auto switches.

- Auto switch proper mounting position (detection at stroke end) and its mounting height
- Minimum stroke for auto switch mounting
- Operating range
- Auto switch mounting brackets/Part no.

CJ1

CJP

CJ2

JCM

CM2

CM3

CG1

CG3

JMB

MB

MB1

CA2

CS1

CS2

D-□

-X□

Technical Data

# CM2□P Series

## Rod Boot Material

Symbol	Rod boot material	Maximum ambient temperature
J	Nylon tarpaulin	70°C
K	Heat resistant tarpaulin	110°C*

\* Maximum ambient temperature for the rod boot itself.

## Weights

Bore size (mm)		(kg)			
		20	25	32	40
Basic weight	Basic	0.14	0.21	0.27	0.58
	Rod flange	0.20	0.30	0.36	0.70
	Rod trunnion	0.18	0.28	0.33	0.68
Additional weight per 50 mm of stroke		0.05	0.08	0.10	0.17
Option bracket	Single knuckle joint	0.06	0.06	0.06	0.23
	Double knuckle joint (with pin)	0.07	0.07	0.07	0.20

Calculation: (Example) **CM2F32P-100**

- Basic weight.....0.36
- Additional weight.....0.10
- Cylinder stroke.....100 stroke

$$0.36 + 0.10 \times 100/50 = 0.56 \text{ kg}$$



## Construction

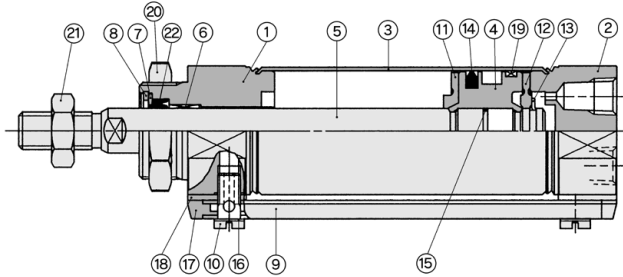

### Component Parts

No.	Description	Material	Note
1	Rod cover	Aluminum alloy	Clear anodized
2	Head cover	Aluminum alloy	Clear anodized
3	Cylinder tube	Stainless steel	
4	Piston	Aluminum alloy	Chromated
5	Piston rod	Carbon steel	Hard chrome plating
6	Bushing	Bearing alloy	
7	Seal retainer	Stainless steel	
8	Retaining ring	Carbon steel	Phosphate coating
9	Pipe	Aluminum alloy	Clear anodized
10	Stud	Brass	Electroless nickel plating
11	Bumper A	Urethane	
12	Bumper B	Urethane	

No.	Description	Material	Note
13	Retaining ring	Stainless steel	
14	Piston seal	NBR	
15	Piston gasket	NBR	
16	Gasket	Resin	
17	Pipe gasket	Urethane rubber	
18	Spacer gasket	Resin	Except ø25
19	Wear ring	Resin	
20	Mounting nut	Carbon steel	Nickel plating
21	Rod end nut	Carbon steel	Zinc chromated

### Replacement Part: Seal

No.	Description	Material	Part no.			
			20	25	32	40
22	Rod seal	NBR	CM220-PS	CM225-PS	CM232-PS	CM240-PS

\* Since the seal does not include a grease pack, order it separately.  
**Grease pack part number: GR-S-010 (10 g)**

## Basic (B)

CM2B Bore size P — Stroke

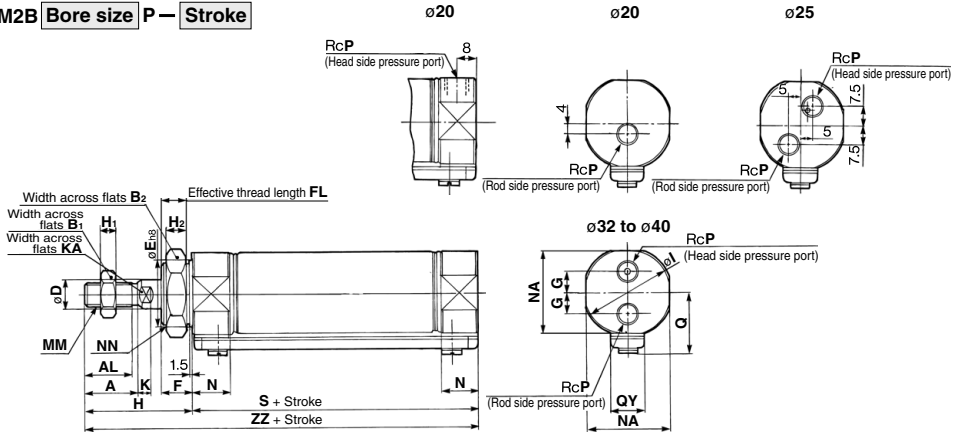

Bore size	A	AL	B <sub>1</sub>	B <sub>2</sub>	D	E	F	FL	G	H	H <sub>1</sub>	H <sub>2</sub>	I	K	KA	MM	N	NA	NN	P	Q	QY	S	ZZ
20	18	15.5	13	26	8	20 <sup>0</sup> <sub>-0.033</sub>	13	10.5	—	41	5	8	28	5	6	M8 x 1.25	15	24	M20 x 1.5	1/8	19.8	14	62	103
25	22	19.5	17	32	10	26 <sup>0</sup> <sub>-0.033</sub>	13	10.5	—	45	6	8	33.5	5.5	8	M10 x 1.25	15	30	M26 x 1.5	1/8	22	14	62	107
32	22	19.5	17	32	12	26 <sup>0</sup> <sub>-0.033</sub>	13	10.5	9	45	6	8	37.5	5.5	10	M10 x 1.25	15	34.5	M26 x 1.5	1/8	25.8	16	64	109
40	24	21	22	41	14	32 <sup>0</sup> <sub>-0.039</sub>	16	13.5	10.5	50	8	10	46.5	7	12	M14 x 1.5	21.5	42.5	M32 x 2	1/4	29.8	16	88	138

\* The dimensions of air cylinders with a rod boot are the same as the standard, double acting/single rod boss-cut type. Refer to page 180.

**CJ1**  
**CJP**  
**CJ2**  
**JCM**  
**CM2**  
**CM3**  
**CG1**  
**CG3**  
**JMB**  
**MB**  
**MB1**  
**CA2**  
**CS1**  
**CS2**

**D-□**  
**-X□**  
 Technical Data

# CM2□P Series

## Rod Flange (F)

CM2F Bore size P – Stroke

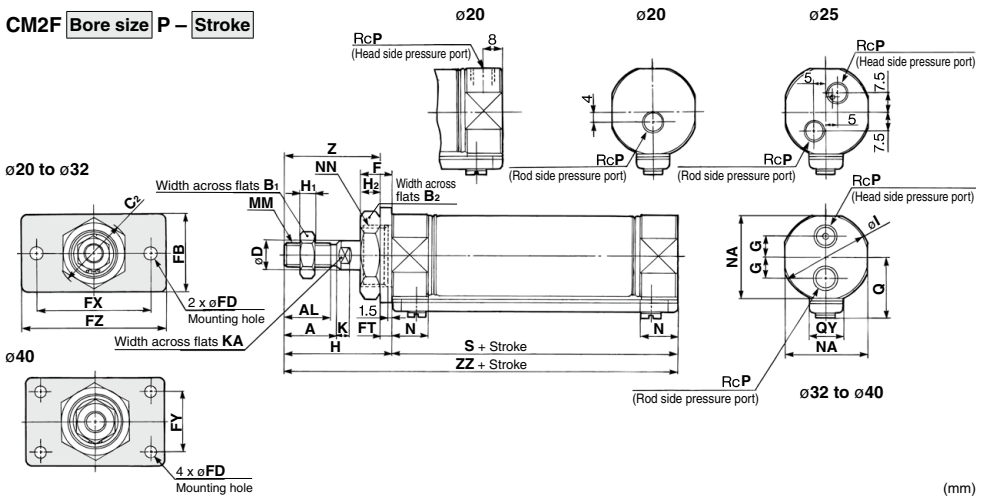

Bore size	A	AL	B <sub>1</sub>	B <sub>2</sub>	C <sub>2</sub>	D	F	FB	FD	FT	FX	FY	FZ	G	H	H <sub>1</sub>	H <sub>2</sub>	I	K	KA	MM	N	NA	NN	P	Q	QY	S	Z	ZZ
20	18	15.5	13	26	30	8	13	34	7	4	60	—	75	—	41	5	8	28	5	6	M8 x 1.25	15	24	M20 x 1.5	1/8	19.8	14	62	37	103
25	22	19.5	17	32	37	10	13	40	7	4	60	—	75	—	45	6	8	33.5	5.5	8	M10 x 1.25	15	30	M26 x 1.5	1/8	22	14	62	41	107
32	22	19.5	17	32	37	12	13	40	7	4	60	—	75	9	45	6	8	37.5	5.5	10	M10 x 1.25	15	34.5	M26 x 1.5	1/8	25.8	16	64	41	109
40	24	21	22	41	47.3	14	16	52	7	5	66	36	82	10.5	50	8	10	46.5	7	12	M14 x 1.5	21.5	42.5	M32 x 2	1/4	29.8	16	88	45	138

\* The bracket is shipped together.

\* The dimensions of air cylinders with a rod boot are the same as the standard, double acting/single rod boss-cut type. Refer to page 180.

## Rod Trunnion (U)

CM2U Bore size P – Stroke

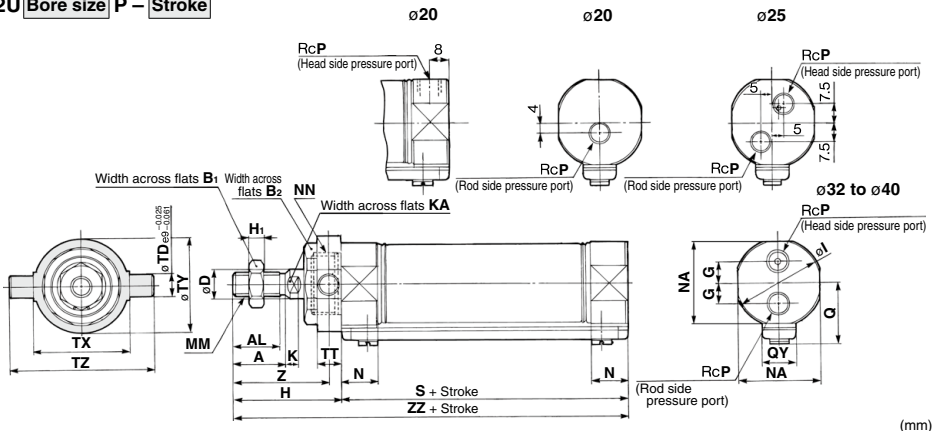

Bore size	A	AL	B <sub>1</sub>	B <sub>2</sub>	D	G	H	H <sub>1</sub>	I	K	KA	MM	N	NA	NN	P	Q	QY	S	TD	TT	TX	TY	TZ	Z	ZZ
20	18	15.5	13	26	8	—	41	5	28	5	6	M8 x 1.25	15	24	M20 x 1.5	1/8	19.8	14	62	8	10	32	32	52	36	103
25	22	19.5	17	32	10	—	45	6	33.5	5.5	8	M10 x 1.25	15	30	M26 x 1.5	1/8	22	14	62	9	10	40	40	60	40	107
32	22	19.5	17	32	12	9	45	6	37.5	5.5	10	M10 x 1.25	15	34.5	M26 x 1.5	1/8	25.8	16	64	9	10	40	40	60	40	109
40	24	21	22	41	14	10.5	50	8	46.5	7	12	M14 x 1.5	21.5	42.5	M32 x 2	1/4	29.8	16	88	10	11	53	53	77	44.5	138

\* The bracket is shipped together.

\* The dimensions of air cylinders with a rod boot are the same as the standard, double acting/single rod boss-cut type. Refer to page 180.

# Air Cylinder: With End Lock

# CBM2 Series

ø20, ø25, ø32, ø40

## How to Order

**CBM2 L 40 - 150 - H N -**

**With auto switch CDBM2 L 40 - 150 - H N - M9BW - C -**

**With auto switch (Built-in magnet)**

**Mounting**

<b>B</b>	Basic	<b>T</b>	Head trunnion
<b>L</b>	Axial foot	<b>E</b>	Integrated clevis
<b>F</b>	Rod flange	<b>BZ</b>	Boss-cut/Basic
<b>G</b>	Head flange	<b>FZ</b>	Boss-cut/Rod flange
<b>C</b>	Single clevis	<b>UZ</b>	Boss-cut/Rod trunnion
<b>D</b>	Double clevis		
<b>U</b>	Rod trunnion		

**Bore size**

<b>20</b>	20 mm
<b>25</b>	25 mm
<b>32</b>	32 mm
<b>40</b>	40 mm

**Cylinder stroke (mm)**

Refer to "Standard Strokes" on page 252.

**Manual release**

<b>N</b>	Non-locking type
<b>L</b>	Locking type

**Lock position**

<b>H</b>	Head end lock
<b>R</b>	Rod end lock
<b>W</b>	Double end lock

**Auto switch mounting bracket<sup>(Note)</sup>**

Note) This symbol is indicated when the D-A9□ or M9□ type auto switch is specified. This mounting bracket does not apply to other auto switches (D-C7□ and H7□, etc.) (Nil)

**Number of auto switches**

<b>Nil</b>	2 pcs.
<b>S</b>	1 pc.
<b>n</b>	"n" pcs.

**Auto switch**

<b>Nil</b>	Without auto switch
------------	---------------------

**Auto switch**

\* For applicable auto switches, refer to the table below.

**Auto switch**

<b>Nil</b>	Without auto switch
------------	---------------------

\* For applicable auto switches, refer to the table below.

**Lock position**

<b>H</b>	Head end lock
<b>R</b>	Rod end lock
<b>W</b>	Double end lock

**Rod boot**

<b>J</b>	None
<b>Nil</b>	Nylon tarpaulin
<b>K</b>	Heat resistant tarpaulin

**Cushion**

<b>Nil</b>	Rubber bumper
<b>A</b>	Air cushion

**Built-in Magnet Cylinder Model**

If a built-in magnet cylinder without an auto switch is required, there is no need to enter the symbol for the auto switch. (Example) CDBM2L40-100-HN

**Made to Order**

Refer to page 252 for details.

## Applicable Auto Switches/Refer to pages 1575 to 1701 for further information on auto switches.

Type	Special function	Electrical entry	Indicator/light	Wiring (Output)	Load voltage		Auto switch model		Lead wire length (m)					Pre-wired connector	Applicable load			
					DC	AC	Perpendicular	In-line	0.5 (Nil)	1 (M)	3 (L)	5 (Z)	None (N)					
																5 V, 12 V	24 V	5 V, 12 V
Solid state auto switch	—	Grommet	No	3-wire (NPN)	5 V, 12 V	—	M9NV	M9N	●	●	●	●	—	—	○	IC circuit		
				3-wire (PNP)			M9PV	M9P	●	●	●	●	—	—	○			
		2-wire		M9BV	M9B	●	●	●	●	—	—	○						
		2-wire		H7C	●	●	●	●	—	—	○							
	Diagnostic indication (2-color indicator)	Terminal conduit	Yes	3-wire (NPN)	24 V	—	—	G39A**	—	—	—	—	●	—	—	IC circuit		
				3-wire (PNP)			—	K39A**	—	—	—	—	●	—	—			
	Water resistant (2-color indicator)	Grommet	No	3-wire (NPN)	5 V, 12 V	—	M9NVV	M9NV	●	●	●	●	—	—	○	IC circuit		
				3-wire (PNP)			M9PVV	M9PV	●	●	●	●	—	—	○			
				2-wire	M9BVV	M9BV	●	●	●	●	—	—	○					
				2-wire	M9NAV*1	M9NA*1	○	○	○	○	—	—	○	IC circuit				
3-wire (PNP)	M9PAV*1	M9PA*1	○	○	○	○	—	—	○									
With diagnostic output (2-color indicator)	Grommet	Yes	2-wire	5 V, 12 V	—	M9BAV*1	M9BA*1	○	○	○	○	—	—	○	IC circuit			
			4-wire (NPN)			—	H7NF	●	—	●	●	—	—	○				
Reed auto switch	—	Grommet	No	3-wire (NPN equivalent)	5 V	—	A96V	A96	●	—	●	—	—	—	—	IC circuit		
				—			A93V*2	A93	●	●	●	●	—	—	—			
				100 V	A90V	A90	●	—	●	—	—	—	—	IC circuit				
				100 V or less	—	B54**	●	—	●	●	—	—	—					
				100 V, 200 V	—	B64**	●	—	●	●	—	—	—					
		200 V or less		—	C73C	●	—	●	●	—	—	—						
		24 V or less		—	C80C	●	—	●	●	—	—	—	IC circuit					
		—		—	A33A**	—	—	—	—	—	—	—						
		Diagnostic indication (2-color indicator)		Grommet	Yes	100 V,	24 V	12 V	—	A34A**	—	—	—	—	—	—	—	PLC
						200 V			—	A44A**	—	—	—	—	—	—		
—	—		B59W			●			—	●	—	—	—	—				

\*1 Water resistant type auto switches can be mounted on the above models, but in such case SMC cannot guarantee water resistance.

\*2 Please contact SMC regarding water resistant types with the above model numbers.

\*3 2.1 m type lead wire is only applicable to D-A93.

\*4 Lead wire length symbols: 0.5 m ..... Nil (Example) M9NV  
1 m ..... M (Example) M9NVW  
3 m ..... L (Example) M9NWL  
5 m ..... Z (Example) M9NVZ  
None ..... N (Example) H7CN

\*5 Solid state auto switches marked with "○" are produced upon receipt of order.

\*6 Do not indicate suffix "N" for no lead wire on D-A3□/A44A/G39A/K39A models.

\*7 The D-A3□/A44A/G39A/K39A/B54/B64 cannot be mounted on bore sizes ø20 and ø25 cylinder with air cushion.

\*8 Since there are other applicable auto switches than listed above, refer to page 266 for details.

\*9 For details about auto switches with pre-wired connector, refer to pages 1648 and 1649.

\*10 The D-A9□/M9□□□ auto switches are shipped together, (but not assembled). (However, only the auto switch mounting brackets are assembled before shipment.)

CJ1

CJP

CJ2

JCM

CM2

CM3

CG1

CG3

JMB

MB

MB1

CA2

CS1

CS2

D-□

-X□

Technical Data

# CBM2 Series

Holds the cylinder's home position even if the air supply is cut off.

When air is discharged at the stroke end position, the lock engages to maintain the rod in that position.

**Non-locking type and locking type are standardized for manual release.**

**Auto switch is mountable.**



## Symbol

Rubber bumper

Air cushion

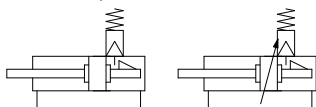

**Made to Order**  
[Click here for details](#)

Symbol	Specifications
-XA□	Change of rod end shape
-XB6	Heat resistant cylinder (-10 to 150°C)
-XB9	Low speed cylinder (10 to 50 mm/s)
-XC3	Special port location
-XC4 *1	With heavy duty scraper
-XC5	Heat resistant cylinder (-10 to 110°C)
-XC6 *2	Made of stainless steel
-XC8 *1	Adjustable stroke cylinder/Adjustable extension type
-XC13	Auto switch rail mounting
-XC22	Fluororubber seal
-XC25	No fixed throttle of connection port
-XC27	Double clevis and double knuckle pins made of stainless steel
-XC29	Double knuckle joint with spring pin
-XC35	With coil scraper
-XC52	Mounting nut with set screw

\*1 Available only for locking at head end

\*2 Double end lock is available as a special order.

## Specifications

Bore size (mm)	20	25	32	40
Type	Pneumatic			
Action	Double acting, Single rod			
Fluid	Air			
Proof pressure	1.5 MPa			
Maximum operating pressure	1.0 MPa			
Minimum operating pressure	0.15 MPa *			
Ambient and fluid temperature	Without auto switch: -10°C to 70°C With auto switch: -10°C to 60°C (No freezing)			
Cushion	Rubber bumper, Air cushion			
Lubrication	Not required (Non-lube)			
Stroke length tolerance	+1.4 mm			
Piston speed	Rubber bumper	50 to 750 mm/s		
	Air cushion	50 to 1000 mm/s		
Mounting	Basic, Axial foot, Rod flange, Head flange, Single clevis, Double clevis, Rod trunnion, Head trunnion			

\* 0.05 MPa for other part than the lock unit

## Lock Specifications

Lock position	Head end, Rod end, Double end			
	ø20	ø25	ø32	ø40
Holding force (Max.) (N)	215	330	550	860
Backlash	1 mm or less			
Manual release	Non-locking type, Locking type			

## Allowable Kinetic Energy

Bore size (mm)		20	25	32	40
Rubber bumper	Allowable kinetic energy (J)	0.27	0.4	0.65	1.2
	Effective cushion length (mm)	11.0	11.0	11.0	11.8
Air cushion	Cushion sectional area (cm <sup>2</sup> )	2.09	3.30	5.86	9.08
	Absorbable kinetic energy (J)	0.54	0.78	1.27	2.35

## Standard Strokes

Bore size (mm)	Standard stroke (mm)	Long stroke * (mm)	Maximum manufacturable stroke (mm)
20	25, 50, 75, 100, 125, 150, 200, 250 300	400	1000
25		450	
32		450	
40		500	

\* Long stroke applies to the axial foot and rod flange types only.

When using other types of mounting brackets or exceeding the long stroke limit, refer to "Air Cylinders Model Selection" on front matter pages.

\* Manufacture of intermediate strokes at 1 mm intervals is possible. (Spacers are not used.)

Refer to pages 262 to 266 for cylinders with auto switches.

- Auto switch proper mounting position (detection at stroke end) and its mounting height
- Minimum stroke for auto switch mounting
- Operating range
- Auto switch mounting brackets/Part no.

## Accessories

For details, refer to pages 189 and 190, since it is the same as CM2 series standard type.

Standard	Mounting nut, Rod end nut, Lock release bolt (N type only)
Option	Single knuckle joint, Double knuckle joint (with pin)

- \* Mounting nuts are not equipped to single clevis and double clevis.
  - \* Stainless steel mounting brackets and accessories are also available.
- Refer to page 190 for details.

## Rod Boot Material

Symbol	Rod boot material	Max. ambient temperature
J	Nylon tarpaulin	60°C
K	Heat resistant tarpaulin	110°C*

\* Maximum ambient temperature for the rod boot itself.

## Weights

Bore size (mm)		20	25	32	40
Basic weight	Basic	0.14	0.21	0.28	0.56
	Axial foot	0.29	0.37	0.44	0.83
	Flange	0.20	0.30	0.37	0.68
	Single clevis	0.18	0.25	0.32	0.65
	Double clevis	0.19	0.27	0.33	0.69
	Trunnion	0.18	0.28	0.34	0.66
	Boss-cut/Basic	0.13	0.19	0.26	0.53
	Boss-cut/Flange	0.19	0.28	0.35	0.65
	Boss-cut/Trunnion	0.17	0.26	0.32	0.63
Additional weight per 50 mm of stroke		0.04	0.06	0.08	0.13
Option bracket	Clevis pivot bracket (with pin)	0.07	0.07	0.14	0.14
	Single knuckle joint	0.06	0.06	0.06	0.23
	Double knuckle joint (with pin)	0.07	0.07	0.07	0.20
	Pivot bracket	0.06	0.06	0.06	0.06
	Pivot bracket pin	0.02	0.02	0.02	0.03

## Lock Unit Additional Weights

Bore size (mm)		20	25	32	40
Non-locking type manual release (N)	Head end lock (H)	0.02	0.02	0.02	0.04
	Rod end lock (R)	0.01	0.01	0.01	0.02
	Double end lock (W)	0.03	0.03	0.03	0.06
Locking type manual release (L)	Head end lock (H)	0.03	0.03	0.03	0.06
	Rod end lock (R)	0.02	0.02	0.02	0.04
	Double end lock (W)	0.05	0.05	0.05	0.10

Calculation: (Example) **CBM2L32-100-HN**

- Basic weight.....0.44 (Foot, ø32)
- Additional weight.....0.08/50 stroke
- Cylinder stroke.....100 stroke
- Lock unit weight.....0.02 (Locking at head end, Non-locking type manual release)

$$0.44 + 0.08 \times 100/50 + 0.02 = \mathbf{0.62 \text{ kg}}$$

## Mounting Brackets/Part No.

Mounting bracket	Min. order qty	Bore size (mm)				Contents (for minimum order quantity)
		20	25	32	40	
Axial foot*	2	CM-L020B	CM-L032B	CM-L040B		2 foots, 1 mounting nut
Flange	1	CM-F020B	CM-F032B	CM-F040B		1 flange
Single clevis**	1	CM-C020B	CM-C032B	CM-C040B		1 single clevis, 3 liners
Double clevis (with pin)***	1	CM-D020B	CM-D032B	CM-D040B		1 double clevis, 3 liners, 1 clevis pin, 2 retaining rings
Double clevis pin	1		CDP-1	CDP-2		1 clevis pin, 2 retaining rings (split pins)
Trunnion (with nut)	1	CM-T020B	CM-T032B	CM-T040B		1 trunnion, 1 trunnion nut
Rod end nut	1	NT-02	NT-03	NT-04		1 rod end nut
Mounting nut	1	SN-020B	SN-032B	SN-040B		1 mounting nut
Trunnion nut	1	TN-020B	TN-032B	TN-040B		1 trunnion nut
Single knuckle joint	1	I-020B	I-032B	I-040B		1 single knuckle joint
Double knuckle joint	1	Y-020B	Y-032B	Y-040B		1 double knuckle joint, 1 knuckle pin, 2 retaining rings
Double knuckle joint pin	1		CDP-1	CDP-3		1 knuckle pin, 2 retaining rings (split pins)
Clevis pivot bracket pin (For CM2E/CM2V)	1	CD-S02		CD-S03		1 clevis pin, 2 retaining rings
Clevis pivot bracket (For CM2E/CM2V)	1	CM-E020B		CM-E032B		1 clevis pivot bracket, 1 clevis pin, 2 retaining rings
Pivot bracket (For CM2C)	1		CM-B032		CM-B040	2 pivot brackets (1 of each type)
Pivot bracket pin (For CM2C)	1		CDP-1		CD-S03	1 pin, 2 retaining rings
Pivot bracket (For CM2T/CM2U)	1	CM-B020	CM-B032		CM-B040	2 pivot brackets (1 of each type)

\* Order 2 foots per cylinder.

\*\* 3 liners are included with a clevis bracket for adjusting the mounting angle.

\*\*\* A clevis pin and retaining rings (split pins for ø40) are included.

For dimensions of accessories (options), refer to pages 189 and 190.

CJ1  
CJP  
CJ2  
JCM  
CM2  
CM3  
CG1  
CG3  
JMB  
MB  
MB1  
CA2  
CS1  
CS2

D-□  
-X□  
Technical Data

# CBM2 Series

## Double Rod Type End Lock Cylinder

CBM2W   —  — H

↓ Double rod type end lock cylinder

### Specifications

Action	Double acting, Double rod
Bore size (mm)	ø20, ø25, ø32, ø40
Max. operating pressure	1.0 MPa
Min. operating pressure	0.15 MPa
Cushion	Rubber bumper
Piston speed	50 to 750 mm/s
Mounting	Basic, Foot, Flange, Trunnion
Lock position	Head end lock
Max. manufacturable stroke	500 mm

Note 1) Auto switch can be mounted.

Note 2) Refer to the Precautions on page 257 when mounting flange and trunnion brackets on the end lock side.

Note 3) When exceeding 300 strokes, refer to the stroke selection table.

### Dimensions

Bore size (mm)	H	ZZ
20	41	144
25	45	152
32	45	154
40	50	188

\* Dimensions for other bore sizes are the same as the double acting single rod model.

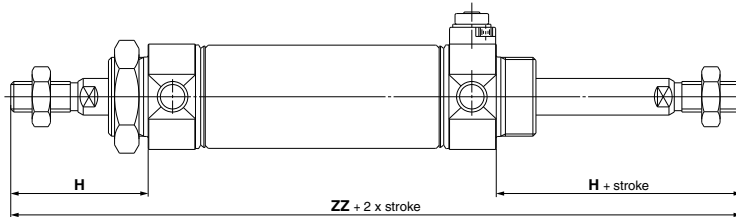

## Non-rotating Rod Type End Lock Cylinder

CBM2K   —  — H

↓ Non-rotating rod type end lock cylinder

### Specifications

Action	Double acting, Double rod
Bore size (mm)	ø20, ø25, ø32, ø40
Max. operating pressure	1.0 MPa
Min. operating pressure	0.15 MPa
Cushion	Rubber bumper
Piston speed	50 to 500 mm/s
Mounting	Basic, Foot, Rod flange, Head flange, Single clevis, Double clevis, Rod trunnion, Head trunnion
Lock position	Head end lock
Max. manufacturable stroke	1000 mm

Note 1) Auto switch can be mounted.

Note 2) Refer to the Precautions on page 257 for the head flange and head trunnion types.

Note 3) When exceeding 300 strokes, refer to the stroke selection table.

### Dimensions

Bore size (mm)	KA
20	8.2
25	10.2
32	12.2
40	14.2

\* Dimensions for other bore sizes are the same as the double acting single rod model.

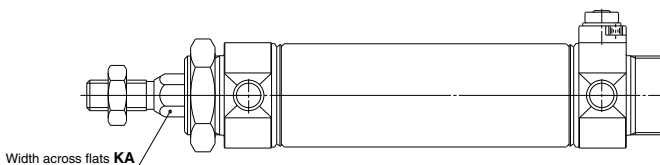

## Construction

### Head end lock

Non-locking type manual release: Suffix N

Locking type manual release: Suffix L

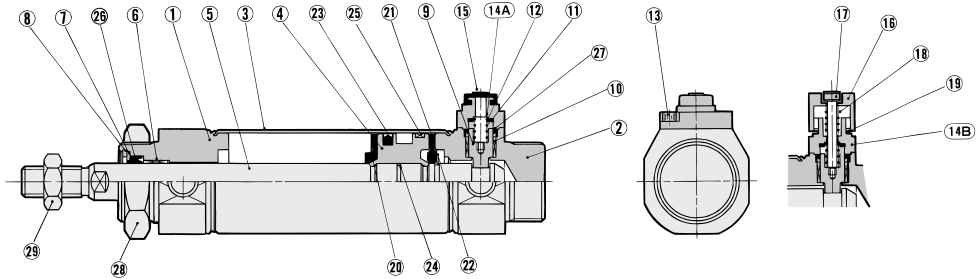

### Rod end lock

With air cushion

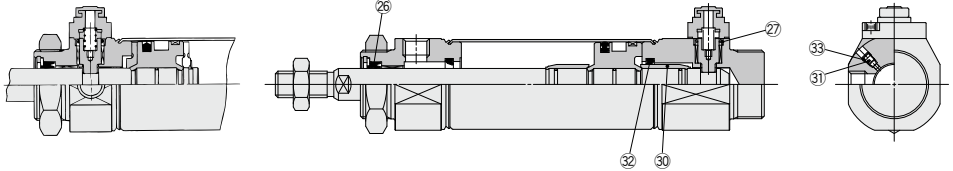

### Component Parts

No.	Description	Material	Note
1	Rod cover	Aluminum alloy	Clear anodized
2	Head cover	Aluminum alloy	Clear anodized
3	Cylinder tube	Stainless steel	
4	Piston	Aluminum alloy	Chromated
5	Piston rod	Carbon steel	Hard chrome plating
6	Bushing	Bearing alloy	
7	Seal retainer	Stainless steel	
8	Retaining ring	Carbon steel	Phosphate coating
9	Lock piston	Carbon steel	Hard chrome plating. Heat treated
10	Lock bushing	Bearing alloy	
11	Lock spring	Stainless steel	
12	Bumper	Urethane	
13	Hexagon socket head cap screw	Alloy steel	Black zinc chromated
14A	Cap A	Aluminum die-casted	Black painted
14B	Cap B	Carbon steel	Oxide film treated
15	Rubber cap	Synthetic rubber	
16	M/O knob	Zinc die-casted	Black painted
17	M/O bolt	Alloy steel	Black zinc chromated. Red painted
18	M/O spring	Steel wire	Zinc chromated
19	Stopper ring	Carbon steel	Zinc chromated
20	Bumper A	Urethane	
21	Bumper B	Urethane	
22	Retaining ring	Stainless steel	
23	Piston seal	NBR	
24	Piston gasket	NBR	
25	Wear ring	Resin	
28	Mounting nut	Carbon steel	Nickel plating
29	Rod end nut	Carbon steel	Zinc chromated
30	Cushion ring	Aluminum alloy	Anodized
31	Cushion needle	Alloy steel	Electroless nickel plating
32	Cushion seal	Urethane	

### Component Parts

No.	Description	Material	Note
26	Rod seal	NBR	
27	Lock piston seal	NBR	
33	Cushion needle seal	NBR	

### Replacement Parts: Seal Kit

With one end lock

Bore size (mm)	20	25	32	40
Kit no.	CBM2-20-PS	CBM2-25-PS	CBM2-32-PS	CBM2-40-PS

With double end lock

Kit no.	CBM2-20-PS-W	CBM2-25-PS-W	CBM2-32-PS-W	CBM2-40-PS-W
---------	--------------	--------------	--------------	--------------

\* Seal kit includes 26 and 27. Order the seal kit, based on each bore size. (Except 33.)

\* Seal kit includes a grease pack (10 g). Order with the following part number when only the grease pack is needed.

**Grease pack part number: GR-S-010 (10 g)**

### How to Replace the Rod Seal

#### <Removal>

- Remove the retaining ring (A) by using a tool for installing a type C retaining ring for hole. Shut off the port on the rod cover by finger and then pull out the piston rod, and the seal retainer (B) and the rod seal (C) are removed.

#### <Mounting>

- After applying enough grease on the rod seal, attach in this order, rod seal (C), seal retainer (B) and retaining ring (A).

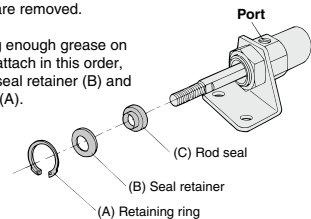

CJ1

CJP

CJ2

JCM

**CM2**

CM3

CG1

CG3

JMB

MB

MB1

CA2

CS1

CS2

D-□

-X□

Technical Data

# CBM2 Series

**Basic** (Dimensions are common irrespective of the lock position; rod end, head end or double end.)

## Head end lock: CBM2B Bore size – Stroke -HN

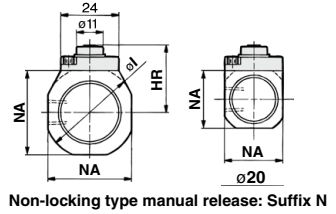
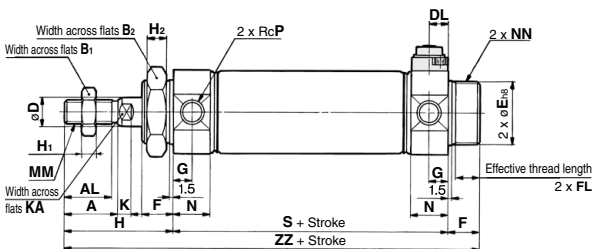

## Rod end lock: CBM2B Bore size – Stroke -RN

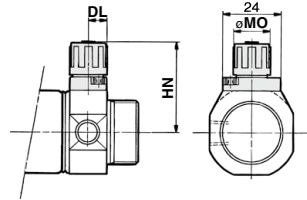
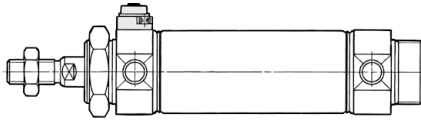

## Double end lock: CBM2B Bore size – Stroke -WN

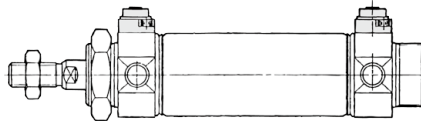

Locking type manual release: Suffix L

### With rod boot

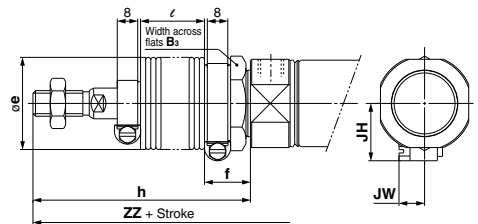

Symbol	Stroke range	A	AL	B <sub>1</sub>	B <sub>2</sub>	D	DL	E	F	FL	G	H	H <sub>1</sub>	H <sub>2</sub>	HR	HN (Max.)	I	K	KA	MM	MO	N	NA	NN	P	S	ZZ
20	Up to 300	18	15.5	13	26	8	7.5	20 <sup>0</sup> <sub>-0.033</sub>	13	10.5	8	41	5	8	22.3	34	28	5	6	M8 x 1.25	15	15	24	M20 x 1.5	1/8	62	116
25	Up to 300	22	19.5	17	32	10	7.5	26 <sup>0</sup> <sub>-0.033</sub>	13	10.5	8	45	6	8	25.3	37	33.5	5.5	8	M10 x 1.25	15	15	30	M26 x 1.5	1/8	62	120
32	Up to 300	22	19.5	17	32	12	7.5	26 <sup>0</sup> <sub>-0.033</sub>	13	10.5	8	45	6	8	27.6	39.3	37.5	5.5	10	M10 x 1.25	15	15	34.5	M26 x 1.5	1/8	64	122
40	Up to 300	24	21	22	41	14	10.7	32 <sup>0</sup> <sub>-0.039</sub>	16	13.5	11	50	8	10	33.6	47.8	46.5	7	12	M14 x 1.5	19	21.5	42.5	M32 x 2	1/4	88	154

### With Rod Boot

Symbol	B <sub>3</sub>	e	f	h								l							
				1 to 50	51 to 100	101 to 150	151 to 200	201 to 300	301 to 400	401 to 500	1 to 50	51 to 100	101 to 150	151 to 200	201 to 300	301 to 400	401 to 500		
20	30	36	18	68	81	93	106	131	156	181	12.5	25	37.5	50	75	100	125		
25	32	36	18	72	85	97	110	135	160	185	12.5	25	37.5	50	75	100	125		
32	32	36	18	72	85	97	110	135	160	185	12.5	25	37.5	50	75	100	125		
40	41	46	20	77	90	102	115	140	165	190	12.5	25	37.5	50	75	100	125		

### With Rod Boot

Symbol	ZZ								JH	JW
	1 to 50	51 to 100	101 to 150	151 to 200	201 to 300	301 to 400	401 to 500			
20	143	156	168	181	206	231	256	23.5	10.5	
25	147	160	172	185	210	235	260	23.5	10.5	
32	149	162	174	187	212	237	262	23.5	10.5	
40	181	194	206	219	244	269	294	27	10.5	

\* For details about the rod end nut and accessories, refer to pages 189 and 190.



## With Mounting Bracket (For dimensions other than shown below, refer to page 256.)

**Axial foot: CBM2L** Bore size – Stroke  $\begin{matrix} -H \\ -R \\ -L \\ -W \end{matrix} N^*$

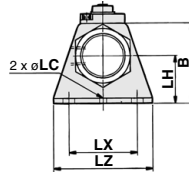
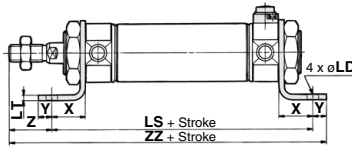

**Rod flange: CBM2F** Bore size – Stroke  $\begin{matrix} -H \\ -R \\ -L \\ -W \end{matrix} N^*$

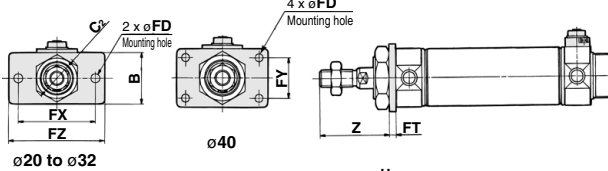

**Head flange: CBM2G** Bore size – Stroke  $\begin{matrix} -H \\ -R \\ -L \\ -W \end{matrix} N^*$

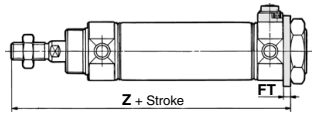

**Single clevis: CBM2C** Bore size – Stroke  $\begin{matrix} -H \\ -R \\ -L \\ -W \end{matrix} N^*$

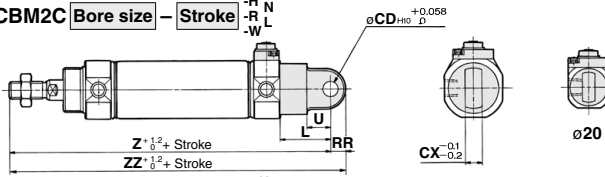

**Double clevis: CBM2D** Bore size – Stroke  $\begin{matrix} -H \\ -R \\ -L \\ -W \end{matrix} N^*$

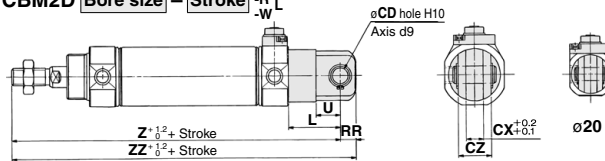

\* A clevis pin and retaining rings (split pins for ø40) are shipped together.

**Rod trunnion: CBM2U** Bore size – Stroke  $\begin{matrix} -H \\ -R \\ -L \\ -W \end{matrix} N^*$

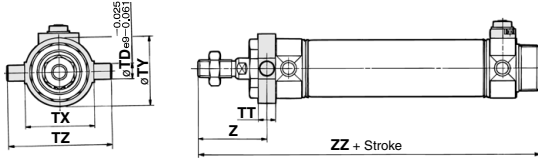

**Head trunnion: CBM2T** Bore size – Stroke  $\begin{matrix} -H \\ -R \\ -L \\ -W \end{matrix} N^*$

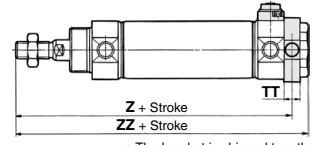

\* The bracket is shipped together.

Bore size (mm)	Axial foot											Flange							Clevis							Trunnion																
	Stroke range	B	LC	LD	LL	LS	LT	LX	LZ	X	Y	Z	ZZ	Stroke range	B	C	FD	FT	FX	FY	FZ	Z	Stroke range	CD	CX	CZ	LR	UR	Z	ZZ	Stroke range	TD	TT	TX	TY	TZ	Z	ZZ				
20	Up to 400	40	4	6.8	25	102	3.2	40	55	20	8	21	131	Up to 400 (Rod side) / Up to 300 (Head side)	34	30	7	4	60	—	75	37	107	Up to 300	9	10	19	30	9	14	133	142	Up to 300	8	10	32	32	52	36	108	116	118
25	Up to 450	47	4	6.8	28	102	3.2	40	55	20	8	25	135	Up to 450 (Rod side) / Up to 300 (Head side)	40	37	7	4	60	—	75	41	111	Up to 300	9	10	19	30	9	14	137	146	Up to 300	9	10	40	40	60	40	112	120	122
32	Up to 450	47	4	6.8	28	104	3.2	40	55	20	8	25	137	Up to 450 (Rod side) / Up to 300 (Head side)	40	37	7	4	60	—	75	41	113	Up to 300	9	10	19	30	9	14	139	148	Up to 300	9	10	40	40	60	40	114	122	124
40	Up to 500	54	4	7	30	134	3.2	55	75	23	10	27	171	Up to 500 (Rod side) / Up to 300 (Head side)	52	47.3	7	5	66	36	82	45	143	Up to 300	10	15	30	39	11	18	177	188	Up to 300	10	11	53	53	77	44.5	143.5	154	154

\* Dimensions other than mentioned above are the same as on page 256.

### Precautions on Trunnion Type, Flange Type

**1. Trunnion type**

(1) Rod trunnion with rod end lock (2) Head trunnion with head end lock (3) With double end lock. For these cases, use caution since the trunnion pin and fittings may be interfered with each other because the trunnion pin and port are very closed to each other.

**2. Flange type (ø20 to ø32)**

(1) Rod flange with rod end lock (2) Head flange with head end lock (3) With double end lock. For these cases, use caution since the bolt for mounting a cylinder and fittings may be interfered with each other.

Refer to "Special Port Location" in "Made to Order" on page 1756.



CJ1
CJP
CJ2
JCM
<b>CM2</b>
CM3
CG1
CG3
JMB
MB
MB1
CA2
CS1
CS2

D-□
-X□
Technical Data

# CBM2 Series

With Air Cushion (For dimensions other than shown below, refer to pages 256 and 257.)

## Basic

Head end lock: **CBM2B** Bore size – Stroke A-HN

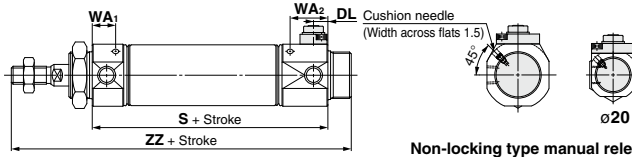

Non-locking type manual release: Suffix N

## With Air Cushion

Bore size (mm)	S			WA1			WA2			ZZ			DL
	Head end lock	Rod end lock	Double end lock	Head end lock	Rod end lock	Double end lock	Head end lock	Rod end lock	Double end lock	Head end lock	Rod end lock	Double end lock	
20	72	73	83	13	24	24	23	13	23	126	127	137	8
25	72	73	83	13	24	24	23	13	23	130	131	141	8
32	72	75	83	13	24	24	21	13	21	130	133	141	8
40	93	96	101	16	24	24	21	16	21	159	162	167	11

Axial foot: **CBM2L** Bore size – Stroke A <sup>-H N\*</sup><sub>-R L</sub>  
<sup>-W</sup>

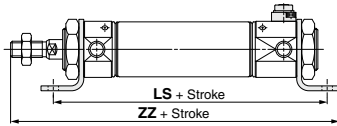

Rod flange: **CBM2F** Bore size – Stroke A <sup>-H N\*</sup><sub>-R L</sub>  
<sup>-W</sup>



Head flange:

**CBM2G** Bore size – Stroke A <sup>-H N\*</sup><sub>-R L</sub>  
<sup>-W</sup>

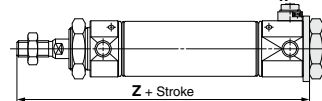

Single clevis: **CBM2C** Bore size – Stroke A <sup>-H N\*</sup><sub>-R L</sub>  
<sup>-W</sup>

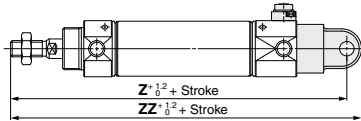

Double clevis: **CBM2D** Bore size – Stroke A <sup>-H N\*</sup><sub>-R L</sub>  
<sup>-W</sup>

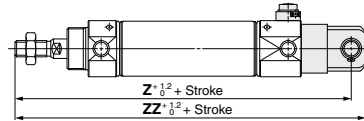

Rod trunnion:

**CBM2U** Bore size – Stroke A <sup>-H N\*</sup><sub>-R L</sub>  
<sup>-W</sup>

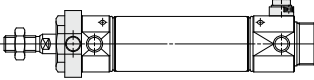

Head trunnion:

**CBM2T** Bore size – Stroke A <sup>-H N\*</sup><sub>-R L</sub>  
<sup>-W</sup>

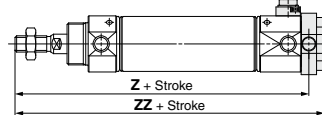

\* The bracket is shipped together.

Bore size (mm)	Axial foot									Head flange		
	LS			ZZ			Z					
	Head end lock	Rod end lock	Double end lock	Head end lock	Rod end lock	Double end lock	Head end lock	Rod end lock	Double end lock	Head end lock	Rod end lock	Double end lock
20	112	113	123	141	142	152	117	118	128			
25	112	113	123	145	146	156	121	122	132			
32	112	115	123	145	148	156	121	124	132			
40	139	142	147	176	179	184	148	151	156			

Bore size (mm)	Clevis						Head trunnion					
	Z			ZZ			Z			ZZ		
	Head end lock	Rod end lock	Double end lock	Head end lock	Rod end lock	Double end lock	Head end lock	Rod end lock	Double end lock	Head end lock	Rod end lock	Double end lock
20	143	144	154	152	153	163	118	119	129	128	129	139
25	147	148	158	156	157	167	122	123	133	132	133	143
32	147	150	158	156	159	167	122	125	133	132	135	143
40	182	185	190	193	196	201	148.5	151.5	156.5	159	162	167



# CBM2 Series Specific Product Precautions 1

Be sure to read this before handling the products. Refer to back page 50 for Safety Instructions and pages 3 to 12 for Actuator and Auto Switch Precautions.

For handling precautions, refer to page 175.

## <End Lock Cylinder Precautions>

### Use the Recommended Pneumatic Circuit

#### ⚠ Caution

- This is necessary for proper operation and release of the lock.

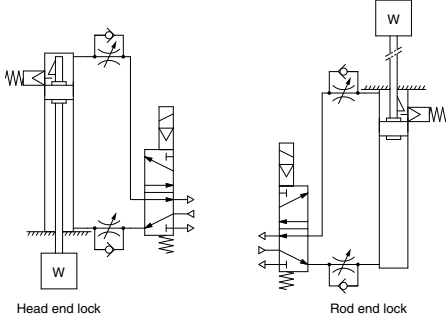

### Handling

#### ⚠ Caution

- Do not use 3 position solenoid valves.**  
Avoid use in combination with 3 position solenoid valves (especially closed center metal seal types). If pressure is trapped in the port on the lock mechanism side, the cylinder cannot be locked. Furthermore, even after being locked, the lock may be released after some time, due to air leaking from the solenoid valve and entering the cylinder.
- Back pressure is required to release end lock.**  
Be sure air is supplied to the side of the cylinder without a lock mechanism (side of the piston rod without lock for double end lock), before starting up, as in the above figures. Otherwise, the lock may not be released. (Refer to "Releasing the Lock".)
- Release the lock when mounting or adjusting the cylinder.**  
If mounting or other work is performed when the cylinder is locked, the lock unit may be damaged.
- Operate with a load ratio of 50% or less.**  
If the load ratio exceeds 50%, this may cause problems such as failure of the lock to release, or damage to the lock unit.
- Do not operate multiple cylinders in synchronization.**  
Avoid applications in which two or more cylinders with end lock are synchronized to move one workpiece, as one of the cylinder locks may not be able to release when required.
- Use a speed controller with meter-out control.**  
Lock cannot be released occasionally by meter-in control.
- Be sure to operate completely to the cylinder stroke end on the side with the lock.**  
If the cylinder piston does not reach the end of the stroke, locking might not work or locking might not be released.
- The base oil of grease may seep out.**  
The base oil of grease in the cylinder may seep out of the tube, cover, or crimped part depending on the operating conditions (ambient temperature 40°C or more, pressurized condition, low frequency operation).

### Operating Pressure

#### ⚠ Caution

1. Supply air pressure of 0.15 MPa or higher to the port on the lock mechanism side, as it is necessary for releasing the lock.

### Exhaust Speed

#### ⚠ Caution

1. The lock will be engaged automatically if the pressure applied to the port on the lock mechanism side falls to 0.05 MPa or less. In cases where the piping on the lock mechanism side is long and thin, or the speed controller is separated at some distance from the cylinder port, the exhaust speed will be reduced. Take note that some time may be required for the lock to engage. In addition, clogging of a silencer mounted on the solenoid valve exhaust port can produce the same effect.

### Relation to Cushion

#### ⚠ Caution

1. When cushion valve at lock mechanism side is fully opened or closed, piston rod may not be reached at stroke end. Thus, lock is not established. And when locking is done at cushion valve fully closed, adjust cushion valve since lock may not be released.

### Releasing the Lock

#### ⚠ Warning

1. Before releasing the lock, be sure to supply air to the side without a lock mechanism, so that there is no load applied to the lock mechanism when it is released. (Refer to the recommended pneumatic circuits.) If the lock is released when the port on the other side is in an exhaust state, and with a load applied to the lock unit, the lock unit may be subjected to an excessive force and be damaged. Furthermore, sudden movement of the piston rod is very dangerous.

CJ1

CJP

CJ2

JCM

CM2

CM3

CG1

CG3

JMB

MB

MB1

CA2

CS1

CS2

D-□

-X□

Technical  
Data



# CBM2 Series Specific Product Precautions 2

Be sure to read this before handling the products. Refer to back page 50 for Safety Instructions and pages 3 to 12 for Actuator and Auto Switch Precautions.

## Manual Release

### ⚠ Caution

#### 1. Non-locking type manual release

Insert the accessory bolt from the top of the rubber cap (it is not necessary to remove the rubber cap), and after screwing it into the lock piston, pull it to release the lock. If you stop pulling the bolt, the lock will return to an operational state.

Thread sizes, pulling forces and strokes are as shown below.

Bore size (mm)	Thread size	Pulling force	Stroke (mm)
20, 25, 32	M2.5 x 0.45 x 25 L or more	4.9 N	2
40	M3 x 0.5 x 30 L or more	10 N	3

Remove the bolt for normal operation.

It can cause lock malfunction or faulty release.

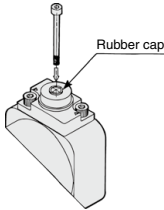

#### 2. Locking type manual release

While pushing the M/O knob, turn it 90° counterclockwise. The lock is released (and remains in a released state) by aligning the ▲ mark on the cap with the ▼OFF mark on the M/O knob. When locking is desired, turn M/O knob clockwise 90° while pushing fully, correspond ▲ mark on cap and ▼ON mark on M/O knob. The correct position is confirmed by a clicking sound.

If not confirmed, locking is not done.

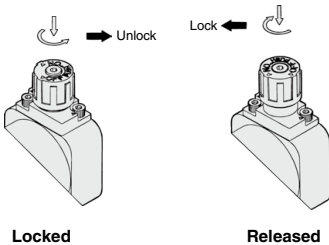

## Working Principle

The figures below are the same as those for CBA2 series.

### ●Head end lock (Rod end lock is the same, too.)

1. When the piston rod is getting closer to the stroke end, the taper part (\*) of the piston rod edge will push the lock piston up.

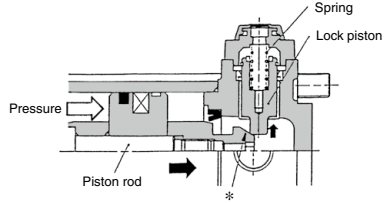

2. Lock piston is pushed up further.

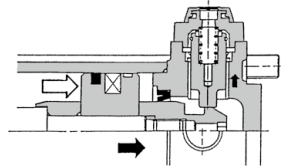

3. Lock piston is pushed up into the groove of piston rod to lock it. (Lock piston is pushed up by spring force.) At this time, it is exhausted from port in head side and introduced to atmosphere.

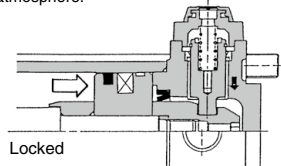

4. When pressure is supplied in the head side, lock piston will be pushed up to release the lock.

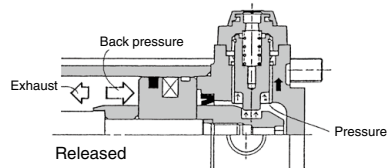

5. Lock will be released, then cylinder will move forward.

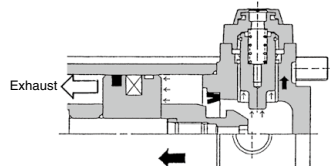



# CM2 Series Auto Switch Mounting

## Auto Switch Proper Mounting Position (Detection at stroke end) and Its Mounting Height

### Solid state auto switch

- D-M9□
- D-M9□W
- D-M9□A

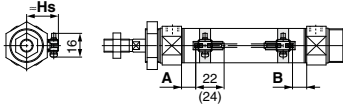

( ): Values for D-M9□A  
A and B are the dimensions from the end of the head cover/rod cover to the end of the auto switch.

- D-M9□V
- D-M9□WV
- D-M9□AV

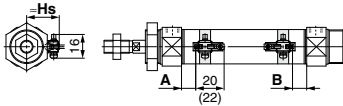

( ): Values for D-M9□AV  
A and B are the dimensions from the end of the head cover/rod cover to the end of the auto switch.

### D-H7□/H7□W/H7NF/H7BA/H7C

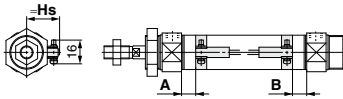

### D-G5NT

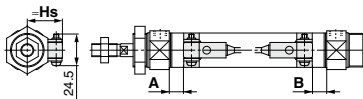

### D-G39A/K39A

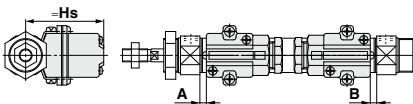

### Reed auto switch

- D-A9□

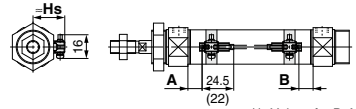

( ): Values for D-A96  
A and B are the dimensions from the end of the head cover/rod cover to the end of the auto switch.

- D-A9□V

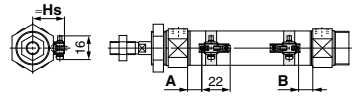

A and B are the dimensions from the end of the head cover/rod cover to the end of the auto switch.

### D-C7/C8/C73C/C80C

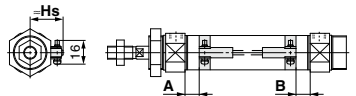

### D-B5/B6/B59W

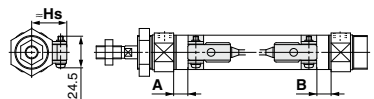

### D-A33A/A34A

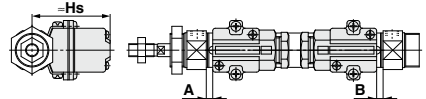

### D-A44A

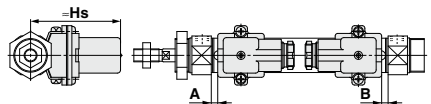

**Auto Switch Proper Mounting Position (Detection at stroke end) and Its Mounting Height**

**Auto Switch Proper Mounting Position**

(Standard type (except single acting type), Non-rotating rod type, Direct mount type, Direct mount, Non-rotating rod type (except single acting type)) (mm)

Auto switch model	D-M9□(V) D-M9□W(V) D-M9□A(V)		D-A9□(V)		D-G39A D-K39A D-A3□A D-A44A		D-H7□ D-H7C D-H7□W D-H7BA D-H7NF		D-G5NT		D-C7/C8 D-C73C D-C80C		D-B5□ D-B64		D-B59W	
	A	B	A	B	A	B	A	B	A	B	A	B	A	B	A	B
20	11	9.5	7	5.5	1	0	6.5	5	3	1.5	7.5	6	1.5	0	4	3
25	10	10	6	6	0	0	5.5	5.5	2	2	6.5	6.5	0.5	0.5	3.5	3.5
32	11.5	10.5	7.5	6.5	1.5	0.5	7	6	3.5	2.5	8	7	2	1	5	4
40	17.5	15.5	13.5	11.5	7.5	5.5	13	11	9.5	7.5	14	12	8	6	11	9

Note) Adjust the auto switch after confirming the operating condition in the actual setting.

**Auto Switch Proper Mounting Position (Centralized piping type, With end lock)**

(mm)

Auto switch model	D-M9□(V) D-M9□W(V) D-M9□A(V)		D-A9□(V)		D-G39A D-K39A D-A3□A D-A44A		D-H7□ D-H7C D-H7□W D-H7BA D-H7NF		D-G5NT		D-B5□ D-B64		D-C7□ D-C80 D-C73C D-C80C		D-B59W	
	A	B	A	B	A	B	A	B	A	B	A	B	A	B	A	B
20	10.5 (8)	9.5 (7)	6.5 (4)	5.5 (3)	0.5 (—)	0 (—)	6 (4)	5 (3)	2.5 (0.5)	1.5 (0)	1 (—)	0 (—)	7 (5)	6 (4)	4 (2)	3 (1)
25	10.5 (8)	9.5 (7)	6.5 (4)	5.5 (3)	0.5 (—)	0 (—)	6 (4)	5 (3)	2.5 (0.5)	1.5 (0)	1 (—)	0 (—)	7 (5)	6 (4)	4 (2)	3 (1)
32	11.5 (9)	10.5 (8)	7.5 (5)	6.5 (4)	1.5 (0)	0.5 (0)	7 (5)	6 (4)	3.5 (1.5)	2.5 (0.5)	2 (0)	1 (0)	8 (6)	7 (5)	5 (3)	4 (2)
40	17.5	15.5	13.5	11.5	6.5	5.5	12	11	8.5	7.5	7	6	13	12	10	9

\* ( ) : Setting position for the auto switch with an air cushion.

The D-B5/B6/A3□A/A44A/G39A/K39A cannot be mounted on the bore size ø20 and ø25 cylinder with an air cushion.

Note 1) Adjust the auto switch after confirming the operating condition in the actual setting.

Note 2) The D-A3□A/A44A/G39A/K39A cannot be mounted on the centralized piping type CDM2□P series.

**Auto Switch Mounting Height**

(mm)

Auto switch model	D-A9□(V) D-M9□(V) D-M9□W(V) D-M9□A(V)		D-B5□ D-B64 D-B59W D-G5NT D-H7C		D-C73C D-C80C		D-G39A D-K39A D-A3□A		D-A44A	
	Hs	Hs	Hs	Hs	Hs	Hs				
20	24.5	25.5	25	60	69.5					
25	27	28	27.5	62.5	72					
32	30.5	31.5	31	66	75.5					
40	34.5	35.5	35	70	79.5					

CG1

CJP

CJ2

JCM

CM2

CM3

CG1

CG3

JMB

MB

MB1

CA2

CS1

CS2

D-□

-X□

Technical Data

# CM2 Series

## Auto Switch Proper Mounting Position (Detection at stroke end) Single Acting/Spring Return Type (S), Spring Extend Type (T)

### Standard Type/Spring Return Type (S)

#### Non-rotating Rod Type/Spring Return Type (S)

(mm)

Auto switch model	Bore size	A dimensions					B
		Up to 50 st	51 to 100 st	101 to 150 st	151 to 200 st	201 to 250 st	
D-M9□(V) D-M9□W(V) D-M9□A(V)	20	36	61	86	—	—	9.5
	25	35	60	85	—	—	10
	32	36.5	61.5	86.5	111.5	—	10.5
	40	42.5	67.5	92.5	117.5	142.5	15.5
D-A9□(V)	20	32	57	82	—	—	5.5
	25	31	56	81	—	—	6
	32	32.5	57.5	82.5	107.5	—	6.5
	40	38.5	63.5	88.5	113.5	138.5	11.5
D-H7□ D-H7C D-H7□W D-H7BA D-H7NF	20	31.5	56.5	81.5	—	—	5
	25	30.5	55.5	80.5	—	—	5.5
	32	32	57	82	107	—	6
	40	38	63	88	113	138	11
D-G5NT	20	28	53	78	—	—	1.5
	25	27	52	77	—	—	2
	32	28.5	53.5	78.5	103.5	—	2.5
	40	34.5	59.5	84.5	109.5	134.5	7.5
D-B5□ D-B64	20	26.5	51.5	76.5	—	—	0
	25	25.5	50.5	75.5	—	—	0.5
	32	27	52	77	102	—	1
	40	33	58	83	108	133	6
D-C7□ D-C80 D-C73C D-C80C	20	32.5	57.5	82.5	—	—	6
	25	31.5	56.5	81.5	—	—	6.5
	32	33	58	83	108	—	7
	40	39	64	89	114	139	12
D-B59W	20	29	54	79	—	—	2.5
	25	28.5	53.5	78.5	—	—	3.5
	32	30	55	80	105	—	4
	40	36	61	86	111	136	9
D-G39A D-K39A D-A3□A D-A44A	20	26	51	76	—	—	0
	25	25	50	75	—	—	0
	32	26.5	51.5	76.5	101.5	—	0.5
	40	32.5	57.5	82.5	107.5	132.5	5.5

Note) Adjust the auto switch after confirming the operating condition in the actual setting.

### Standard Type/Spring Extend Type (T)

#### Non-rotating Rod Type/Spring Extend Type (T)

(mm)

Auto switch model	Bore size	A	B dimensions				
			Up to 50 st	51 to 100 st	101 to 150 st	151 to 200 st	201 to 250 st
D-M9□(V) D-M9□W(V) D-M9□A(V)	20	11	34.5	59.5	84.5	—	—
	25	10	35	60	85	—	—
	32	11.5	35.5	60.5	85.5	110.5	—
	40	17.5	40.5	65.5	90.5	115.5	140.5
D-A9□(V)	20	7	30.5	55.5	80.5	—	—
	25	6	31	56	81	—	—
	32	7.5	31.5	56.5	81.5	106.5	—
	40	13.5	36.5	61.5	86.5	111.5	136.5
D-H7□ D-H7C D-H7□W D-H7BA D-H7NF	20	6.5	30	55	80	—	—
	25	5.5	30.5	55.5	80.5	—	—
	32	7	31	56	81	106	—
	40	13	36	61	86	111	136
D-G5NT	20	3	26.5	51.5	76.5	—	—
	25	2	27	52	77	—	—
	32	3.5	27.5	52.5	77.5	102.5	—
	40	9.5	32.5	57.5	81.5	107.5	132.5
D-B5□ D-B64	20	1.5	25	50	75	—	—
	25	0.5	25.5	50.5	75.5	—	—
	32	2	26	51	76	101	—
	40	8	31	56	81	106	131
D-C7□ D-C80 D-C73C D-C80C	20	7.5	31	56	81	—	—
	25	6.5	31.5	56.5	81.5	—	—
	32	8	32	57	82	107	—
	40	14	37	62	87	112	137
D-B59W	20	4	28	53	78	—	—
	25	3.5	28.5	53.5	78.5	—	—
	32	5	29	54	79	104	—
	40	11	34	59	84	109	134
D-G39A D-K39A D-A3□A D-A44A	20	1	24.5	49.5	74.5	—	—
	25	0	25	50	75	—	—
	32	1.5	25.5	50.5	75.5	100.5	—
	40	7.5	30.5	55.5	80.5	105.5	130.5

Note) Adjust the auto switch after confirming the operating condition in the actual setting.



**Minimum Stroke for Auto Switch Mounting**

(Standard type (except single acting type), Non-rotating rod type, Direct mount type,

**Direct mount, Non-rotating rod type (except single acting type), Centralized piping type, With end lock)**

n: Number of auto switches (mm)

Auto switch model	Number of auto switches				
	With 1 pc.	With 2 pcs.		With n pcs.	
		Different surfaces	Same surface	Different surfaces	Same surface
D-M9□	5	15 Note 1)	40 Note 1)	$20 + 35 \frac{(n-2)}{2}$ (n = 2, 4, 6...) <sup>Note 3)</sup>	$55 + 35 (n-2)$ (n = 2, 3, 4, 5...)
D-M9□W	10	15 Note 1)	40 Note 1)	$20 + 35 \frac{(n-2)}{2}$ (n = 2, 4, 6...) <sup>Note 3)</sup>	$55 + 35 (n-2)$ (n = 2, 3, 4, 5...)
D-M9□A	10	15 Note 1)	40 Note 1)	$25 + 35 \frac{(n-2)}{2}$ (n = 2, 4, 6...) <sup>Note 3)</sup>	$60 + 35 (n-2)$ (n = 2, 3, 4, 5...)
D-A9□	5	15	30 Note 1)	$15 + 35 \frac{(n-2)}{2}$ (n = 2, 4, 6...) <sup>Note 3)</sup>	$50 + 35 (n-2)$ (n = 2, 3, 4, 5...)
D-M9□V	5	15 Note 1)	35	$20 + 35 \frac{(n-2)}{2}$ (n = 2, 4, 6...) <sup>Note 3)</sup>	$35 + 35 (n-2)$ (n = 2, 3, 4, 5...)
D-A9□V	5	15	25	$15 + 35 \frac{(n-2)}{2}$ (n = 2, 4, 6...) <sup>Note 3)</sup>	$25 + 35 (n-2)$ (n = 2, 3, 4, 5...)
D-M9□WV D-M9□AV	10	15 Note 1)	35	$20 + 35 \frac{(n-2)}{2}$ (n = 2, 4, 6...) <sup>Note 3)</sup>	$35 + 35 (n-2)$ (n = 2, 3, 4, 5...)
D-C7□ D-C80	10	15	50	$15 + 45 \frac{(n-2)}{2}$ (n = 2, 4, 6...) <sup>Note 3)</sup>	$50 + 45 (n-2)$ (n = 2, 3, 4, 5...)
D-H7□ D-H7□W D-H7BA D-H7NF	10	15	60	$15 + 45 \frac{(n-2)}{2}$ (n = 2, 4, 6...) <sup>Note 3)</sup>	$60 + 45 (n-2)$ (n = 2, 3, 4, 5...)
D-H7C D-C73C D-C80C	10	15	65	$15 + 50 \frac{(n-2)}{2}$ (n = 2, 4, 6...) <sup>Note 3)</sup>	$65 + 50 (n-2)$ (n = 2, 3, 4, 5...)
D-G5NT D-B5□/B64	10	15	75	$15 + 50 \frac{(n-2)}{2}$ (n = 2, 4, 6...) <sup>Note 3)</sup>	$75 + 55 (n-2)$ (n = 2, 3, 4, 5...)
D-B59W	15	20	75	$20 + 50 \frac{(n-2)}{2}$ (n = 2, 4, 6...) <sup>Note 3)</sup>	$75 + 55 (n-2)$ (n = 2, 3, 4, 5...)
D-G39A <sup>Note 4)</sup> D-K39A D-A3□A D-A44A	10	35	100	$35 + 30 (n-2)$ (n = 2, 3, 4, 5...)	$100 + 100 (n-2)$ (n = 2, 3, 4, 5...)

Note 3) When "n" is an odd number, an even number that is one larger than this odd number is used for the calculation.  
 Note 4) The D-A3□A/A44A/G39A/K39A cannot be mounted on the centralized piping type CDM2□P series.

Note 1) Auto switch mounting

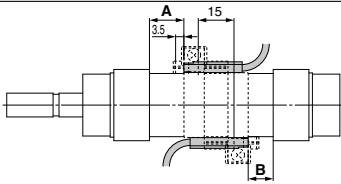
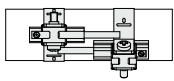
Auto switch model	With 2 auto switches	
	Different surfaces	Same surface
	 <p>The proper auto switch mounting position is 3.5 mm inward from the switch holder edge.</p>	 <p>The auto switch is mounted by slightly displacing it in a direction (cylinder tube circumferential exterior) so that the auto switch and lead wire do not interfere with each other.</p>
D-M9□(V) D-M9□W(V)	15 to 20 stroke <sup>Note 2)</sup>	40 to 55 stroke <sup>Note 2)</sup>
D-M9□A(V)	15 to 25 stroke <sup>Note 2)</sup>	40 to 60 stroke <sup>Note 2)</sup>
D-A9□(V)	—	30 to 50 stroke <sup>Note 2)</sup>

Note 2) Minimum stroke for auto switch mounting in types other than those in Note 1.

- CJ1
- CJP
- CJ2
- JCM
- CM2
- CM3
- CG1
- CG3
- JMB
- MB
- MB1
- CA2
- CS1
- CS2

- D-□
- X□
- Technical Data

## Operating Range

Auto switch model	Bore size (mm)			
	20	25	32	40
D-A9□(V)	6	6	6	6
D-M9□(V) D-M9□W(V) D-M9□A(V)	3	3	4	3.5
D-C7□/C80 D-C73C/C80C	7	8	8	8
D-B5□/B64 D-A3□A/A44A (Note)	8	8	9	9
D-B59W	12	12	13	13
D-H7□/H7□W/H7BA D-G5NT/H7NF	4	4	4.5	5
D-H7C	7	8.5	9	10
D-G39A/K39A (Note)	8	9	9	9

\* Values which include hysteresis are for guideline purposes only, they are not a guarantee (assuming approximately ±30% dispersion) and may change substantially depending on the ambient environment.

Note) The D-A3□A/A44A/G39A/K39A cannot be mounted on the centralized piping type CDM2□P series.

## Auto Switch Mounting Brackets/Part No.

Auto switch model	Bore size (mm)			
	φ20	φ25	φ32	φ40
D-M9□(V) D-M9□W(V) D-A9□(V)	BM5-020 (A set of a, b, c, d)	BM5-025 (A set of a, b, c, d)	BM5-032 (A set of a, b, c, d)	BM5-040 (A set of a, b, c, d)
D-M9□A(V) (Note 2)	BM5-020S (A set of b, c, d, e)	BM5-025S (A set of b, c, d, e)	BM5-032S (A set of b, c, d, e)	BM5-040S (A set of b, c, d, e)

D-H7□ D-H7□W D-H7NF D-C7□/C80 D-C73C/C80C	BM2-020A (A set of band and screw)	BM2-025A (A set of band and screw)	BM2-032A (A set of band and screw)	BM2-040A (A set of band and screw)
D-H7BA	BM2-020AS (A set of band and screw)	BM2-025AS (A set of band and screw)	BM2-032AS (A set of band and screw)	BM2-040AS (A set of band and screw)
D-B5□/B64 D-B59W D-G5NT	BA2-020 (A set of band and screw)	BA2-025 (A set of band and screw)	BA2-032 (A set of band and screw)	BA2-040 (A set of band and screw)
D-A3□A/A44A (Note 3) D-G39A/K39A	BM3-020 (A set of band and screw)	BM3-025 (A set of band and screw)	BM3-032 (A set of band and screw)	BM3-040 (A set of band and screw)

Note 1) Since the switch bracket (made from nylon) are affected in an environment where alcohol, chloroform, methylamines, hydrochloric acid or sulfuric acid is splashed over, so it cannot be used. Please contact SMC regarding other chemicals.

Note 2) As the indicator LED is projected from the switch unit, indicator LED may be damaged if the switch bracket is fixed on the indicator LED.

Note 3) The D-A3□A/A44A/G39A/K39A cannot be mounted on the centralized piping type CDM2□P series.

## Band Mounting Brackets Set Part No.

Set part no.	Contents
BM2-□□□A(S) * S: Stainless steel screw	<ul style="list-style-type: none"> <li>• Auto switch mounting band (c)</li> <li>• Auto switch mounting screw (d)</li> </ul>
BJ4-1	<ul style="list-style-type: none"> <li>• Switch bracket (White/PBT) (e)</li> <li>• Switch holder (b)</li> </ul>
BJ5-1	<ul style="list-style-type: none"> <li>• Switch bracket (Transparent/Nylon) (a)</li> <li>• Switch holder (b)</li> </ul>

Other than the applicable auto switches listed in “How to Order”, the following auto switches are mountable.

Refer to pages 1575 to 1701 for the detailed specifications.

Type	Model	Electrical entry	Features
Solid state	D-H7A1, H7A2, H7B	Grommet (In-line)	—
	D-H7NW, H7PW, H7BW		Diagnostic indication (2-color indicator)
	D-H7BA		Water resistant (2-color indicator)
	D-G5NT		With timer
Reed	D-B53, C73, C76	Grommet (In-line)	—
	D-C80		Without indicator light

\* With pre-wired connector is also available for solid state auto switches. For details, refer to pages 1648 and 1649.

\* Normally closed (NC = b contact) solid state auto switches (D-M9□E(V)) are also available. For details, refer to page 1592-1.

# CM2 Series

# Made to Order: Individual Specifications

Please contact SMC for detailed specifications, delivery and prices.



## 1 PTFE Grease

Symbol  
**-X446**

### Applicable Series

Description	Model	Action	Note
Standard type	CM2	Double acting, Single rod	
	CM2W	Double acting, Double rod	
Non-rotating rod type	CM2K	Double acting, Single rod	
	CM2KW	Double acting, Double rod	
Direct mount type	CM2R	Double acting, Single rod	
Direct mount, Non-rotating rod type	CM2RK	Double acting, Single rod	

### How to Order

Standard model no.

- X446

PTFE grease ↓

**Specifications: Same as standard type**

**Dimensions: Same as standard type**

\* When grease is necessary for maintenance, grease pack is available, please order it separately.  
**GR-F-005** (Grease: 5 g)

### **Warning Precautions**

Be aware that smoking cigarettes etc after your hands have come into contact with the grease used in this cylinder can create a gas that is hazardous to humans.

CJ1

CJP

CJ2

JCM

**CM2**

CM3

CG1

CG3

JMB

MB

MB1

CA2

CS1

CS2

D-□

-X□

Technical Data