

# Stainless Steel One-touch Fittings

New

RoHS

Metal material: **Stainless steel 303**

## Improved tube insertion/removal

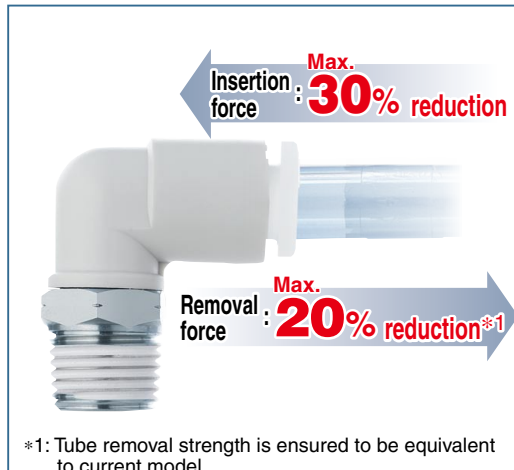

## Compact and lightweight

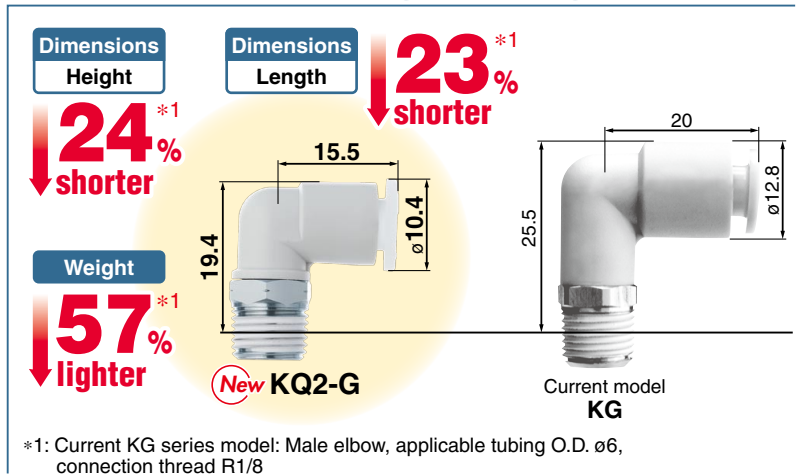

Body type: total of **27** models

Applicable tubing O. D.  $\phi 4, \phi 6, \phi 8, \phi 10, \phi 12, \phi 16$

Connection thread M5x0.8, R, Rc, G 1/8, 1/4, 3/8, 1/2



**KQ2-G Series**

**SMC**

CAT.ES50-39A <sup>Ⓐ</sup>

## Variations

**Hexagon Socket Head Male Connector**  
KQ2S-G



	
Oval type ø4, ø6	Round type ø8 to ø12

**Universal Male Elbow**  
KQ2V-G



	
Oval type ø4, ø6	Round type ø8 to ø12

**Bulkhead Union**  
KQ2E-G



	
Oval type ø4, ø6	Round type ø8 to ø16

**Extended Male Elbow**  
KQ2W-G



	
Oval type ø4, ø6	Round type ø8 to ø12



**Bulkhead Connector**  
KQ2E-G



	
Oval type ø4, ø6	Round type ø8 to ø16



**Male Connector**  
KQ2H-G



	
Oval type ø4, ø6	Round type ø8 to ø16

**Female Connector**  
KQ2F-G



	
Oval type ø4, ø6	Round type ø8 to ø12



**Straight Union**  
KQ2H



	
Oval type ø4, ø6	Round type ø8 to ø16

**Different Diameter Straight**  
KQ2H



	
Oval type ø4, ø6	Round type ø8 to ø16

**Branch Male Elbow**  
KQ2LU-G



Round type ø4 to ø12

**Branch Union Elbow**  
KQ2LU



Round type ø4 to ø12

**Male Elbow**  
KQ2L-G



	
Oval type ø4, ø6	Round type ø8 to ø16



**Union Elbow**  
KQ2L



	
Oval type ø4, ø6	Round type ø8 to ø16

**Plug-in Elbow**  
KQ2L



	
Oval type ø4, ø6	Round type ø8 to ø16

**Male Delta Union**  
KQ2D-G



	
Oval type ø4, ø6	Round type ø8 to ø12

**Delta Union**  
KQ2D



	
Oval type ø4, ø6	Round type ø8 to ø12

**Double Branch "Y"**  
KQ2UD-G





Round type ø4, ø6



**Male Branch Tee**  
KQ2T-G



	
Oval type ø4, ø6	Round type ø8 to ø16



**Union Tee**  
KQ2T



	
Oval type ø4, ø6	Round type ø8 to ø16

**Different Diameter Tee**  
KQ2T



	
Oval type ø4, ø6	Round type ø8 to ø16

**Male Run Tee**  
KQ2Y-G



	
Oval type ø4, ø6	Round type ø8 to ø16

**Different Diameter Double Union "Y"**  
KQ2UD



Round type ø4 to ø8

**Union "Y"**  
KQ2U



Round type ø4 to ø16

**Different Diameter Union "Y"**  
KQ2U





Round type ø4 to ø16



**Branch "Y"**  
KQ2U-G



Round type ø4 to ø12

**Plug-in Reducer**  
KQ2R



	
Oval type ø4, ø6	Round type ø8 to ø12

**Tube Cap**  
KQ2C



	
Oval type ø4, ø6	Round type ø8 to ø16

# Metric Size Stainless Steel One-touch Fittings

Applicable Tubing: Metric Size, Connection Thread: M, R, Rc

## KQ2-G Series

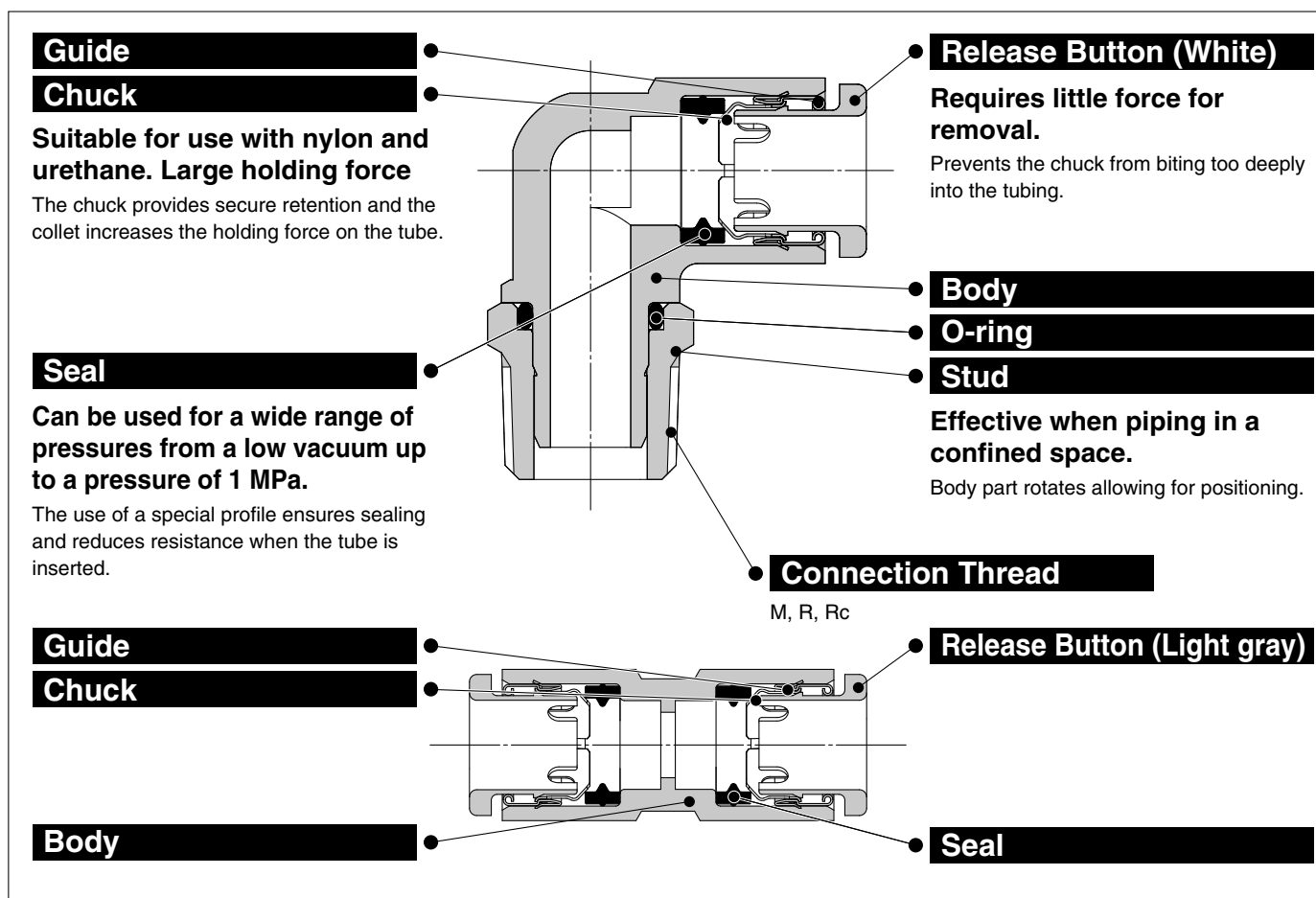

**Stainless specifications for use in corrosive environments**  
Stainless steel 303 is used for metal material.



### Applicable Tubing

Tubing material	FEP, PFA, Nylon, Soft nylon, Polyurethane
Tubing O.D.	ø4, ø6, ø8, ø10, ø12, ø16

### Specifications

<b>Fluid</b>		Air, Water *1 *2
<b>Operating pressure range *3</b>		-100 kPa to 1 MPa
<b>Proof pressure (at 23°C)</b>		3 MPa
<b>Ambient and fluid temperature</b>		-5 to 60°C, Water: 0 to 40°C (No freezing)
<b>Thread</b>	<b>Mounting section</b>	JIS B 0203 (Taper thread for piping) JIS B 0205 (Metric coarse thread)
	<b>Nut section</b>	JIS B 0205 (Metric fine thread)
<b>Seal on the threads</b>		With sealant

\*1: The surge pressure must not exceed the maximum operating pressure.

\*2: Deionized water is not recommended for use as it may affect the material used in the fittings. In addition, it is known to degrade the water quality.

\*3: Do not use the fittings with a leak tester or for vacuum retention because they are not guaranteed for zero leakage.

### Principal Parts Material

Body	Stainless steel 303, PBT
Stud	Stainless steel 303 (Thread portion)
Chuck	Stainless steel 304
Guide	Stainless steel 304, Stainless steel 303, PBT
Release button	POM
Seal, O-ring	NBR
Gasket	Stainless steel 304, NBR



**Made to Order**  
(Refer to page 19 for details.)

# KQ2-G Series

Applicable Tubing: Metric Size, Connection Thread: M, R, Rc

## How to Order

**ø4, ø6** (Oval type release button) **KQ2 H 06 - 01 G S 1**

**ø8 to ø16** (Round type release button) **KQ2 H 08 - 01 G S**

One-touch fittings

Model

Symbol	Model	Oval type	Round type
H	Male connector	○	○
S	Hexagon socket head male connector	○	○
F	Female connector	○	○
L	Male elbow	○	○
LU	Branch male elbow	—	○
V	Universal male elbow	○	○
W	Extended male elbow	○	○
T	Male branch tee	○	○
Y	Male run tee	○	○
D	Male delta union	○	○
U	Branch "Y"	—	○
UD	Double branch "Y"	—	○
E	Bulkhead union	○	○
	Bulkhead connector	○	○

• Oval type release button

• Male thread seal method

Symbol	Seal method
Nil	Without sealant
S	With sealant

• Thread material: **Stainless steel 303**

• Port size/Applicable tubing O.D.

Symbol		Size
Thread connection	M5	M5 x 0.8
	01	R1/8, Rc1/8
	02	R1/4, Rc1/4
	03	R3/8, Rc3/8
Tubing connection	04	R1/2, Rc1/2
	00*1	Same diameter tubing

\*1: Only for "Bulkhead union" and "Bulkhead male elbow"

• Applicable tubing O.D.

Symbol	Size
04	ø4
06	ø6
08	ø8
10	ø10
12	ø12
16	ø16

**Spare Parts**

Use the part number below to order the gasket for M5 thread.  
Gasket for M5 thread: M-5G2

**ø4, ø6** (Oval type release button) **KQ2 H 06 - 00 A 1**

**ø8 to ø16** (Round type release button) **KQ2 H 08 - 00 A**

One-touch fittings

Model

Symbol	Model	Oval type	Round type
H	Straight union	○	○
	Different diameter straight	○	○
L	Union elbow	○	○
	Plug-in elbow	○	○
LU	Branch union elbow	—	○
T	Union tee	○	○
	Different diameter tee	○	○
D	Delta union	○	○
U	Union "Y"	—	○
	Different diameter union "Y"	—	○
UD	Different diameter double union "Y"	—	○
R	Plug-in reducer	○	○

• Oval type release button

• Applicable tubing O.D. (Rod O.D.)

Symbol		Size
Tubing (rod) connection Different dia. tubing (Plug-in reducer)	00	Same diameter tubing
	99	Same diameter rod
	04	ø4
	06	ø6
	08	ø8
	16	ø16

**Accessories/Tube cap**

Model	Applicable tubing O.D. [mm]	Release button shape
KQ2C□-00A1	ø4, ø6	Oval type
KQ2C□-00A	ø8 to ø16	Round type

• Applicable tubing O.D.

Symbol	Size
04	ø4
06	ø6
08	ø8
10	ø10
12	ø12
16	ø16

# Metric Size One-touch Fittings *KQ2-G Series*

## Variations

### Hexagon Socket Head Male Connector

**KQ2S-G**

P.6



Internal hexagon socket allows tightening with a hexagon wrench in confined spaces.

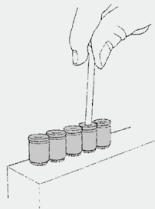

### Universal Male Elbow

**KQ2V-G**

P.10



Hexagon head of the body allows tightening with a box wrench in confined spaces.

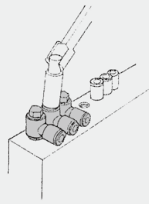

### Bulkhead Union

**KQ2E-G**

P.18



Use to connect tubing through a panel etc.

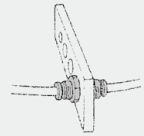

### Extended Male Elbow

**KQ2W-G**

P.12



Basically, it is used together with a male elbow. Its extended height allows for multi-leveled piping and prevents interference among fittings.

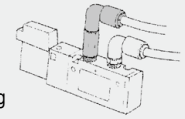

### Bulkhead Connector

**KQ2E-G**

P.18



Use to connect a male thread and tubing through a panel etc.

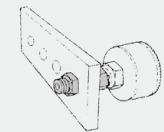

### Male Connector

**KQ2H-G**

P.5



Use to pipe a female thread in the same direction. Most general model.

### Plug-in Elbow

**KQ2L**

P.11



Use to change the tube direction of One-touch fittings by 90°.

### Different Diameter Double Union "Y"

**KQ2UD**

P.17



Use to four-branch tubing in the same direction.

### Female Connector

**KQ2F-G**

P.6



Use to pipe a male thread of a pressure gauge etc.

### Male Delta Union

**KQ2D-G**

P.15



Use to branch a female thread at two right angles.

### Union "Y"

**KQ2U**

P.17



Use to branch tubing in the same direction.

### Straight Union

**KQ2H**

P.7



Use to connect tubing in the same direction.

### Delta Union

**KQ2D**

P.15



Use to branch tubing at three right angles.

### Different Diameter Union "Y"

**KQ2U**

P.17



Use to connect tubing of reduced size for branching in the same direction.

### Different Diameter Straight

**KQ2H**

P.7



Use to connect tubing of different sizes.

### Double Branch "Y"

**KQ2UD-G**

P.16



Use to four-branch a female thread in the same direction.

### Branch "Y"

**KQ2U-G**

P.16



Use to branch a female thread in the same direction.

### Branch Male Elbow

**KQ2LU-G**

P.9



Use to branch a female thread at right angles.

### Male Branch Tee

**KQ2T-G**

P.13



Use to branch a female thread at both 90° angles.

### Plug-in Reducer

**KQ2R**

P.18



Use to change size of One-touch fittings.

### Branch Union Elbow

**KQ2LU**

P.11



Use to branch tubing at right angles.

### Union Tee

**KQ2T**

P.13



Use to branch tubing at both 90° angles.

### Tube Cap

**KQ2C**

P.19



Use to plug unused tubing.

### Male Elbow

**KQ2L-G**

P.8



Use to pipe a female thread at right angles. Most general model.

### Different Diameter Tee

**KQ2T**

P.14



Use to connect tubing of reduced size for branching at both 90° angles.

### Union Elbow

**KQ2L**

P.10



Use to connect tubing at right angles.

### Male Run Tee

**KQ2Y-G**

P.14



Use to branch a female thread in the same direction and at a 90° angle.



# KQ2-G Series

Applicable Tubing: Metric Size, Connection Thread: M, R, Rc

## Dimensions

### Male Connector: KQ2H-G (Gasket seal)

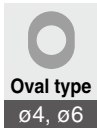

Applicable tubing O.D. [mm]	Connection thread M	Model	H (Width across flats)	øD	Release button dimensions		L	A	M	Effective area [mm <sup>2</sup> ]		Min. port size	Weight [g]
					X	Y				Nylon	Urethane		
ø4	M5 x 0.8	KQ2H04-M5G1	8	7.9	7.7	10	17.7	14.7	13.3	4	4	2.5	3.3
ø6	M5 x 0.8	KQ2H06-M5G1	10	9.9	9.7	12	17.7	14.7	13.3	4	4	2.5	4.1

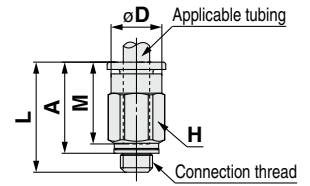

Release button dimensions

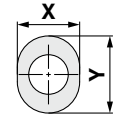

### Male Connector: KQ2H-G (Sealant)

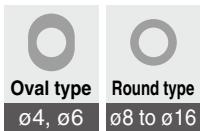

Applicable tubing O.D. [mm]	Connection thread R	Model	H (Width across flats)	øD	Release button dimensions		L	A*1	M	Effective area [mm <sup>2</sup> ]		Min. port size	Weight [g]
					øX (X)	Y				Nylon	Urethane		
ø4	1/8	KQ2H04-01GS1	10	10	7.7	10	14.3	11.2	13.3	4.8	3.4	3	5.6
	1/4	KQ2H04-02GS1	14	14	7.7	10	16.7	12	13.3	4.8	3.4	3	14.6
ø6	1/8	KQ2H06-01GS1	10	9.9	9.7	12	18.4	15.3	13.3	13.1	10.4	4.5	5.8
	1/4	KQ2H06-02GS1	14	14	9.7	12	16.7	12	13.3	13.1	10.4	4.5	12.5
	3/8	KQ2H06-03GS1	17	17	9.7	12	18.1	13	13.3	13.1	10.4	4.5	24.5
ø8	1/8	KQ2H08-01GS	14	12.4	13	—	22.5	19.4	14.2	26.1	18	6	11.9
	1/4	KQ2H08-02GS	14	12.4	13	—	22	17.3	14.2	26.1	18	6	13.9
	3/8	KQ2H08-03GS	17	17	13	—	18.1	13	14.2	26.1	18	6	21
ø10	1/8	KQ2H10-01GS	17	14.8	15.6	—	23.8	20.7	15.6	26.1	26.1	6	16.9
	1/4	KQ2H10-02GS	17	14.8	15.6	—	27.3	22.6	15.6	41.5	29.5	7.5	22.1
	3/8	KQ2H10-03GS	17	14.8	15.6	—	23.5	18.4	15.6	41.5	29.5	7.5	22.5
ø12	1/2	KQ2H10-04GS	22	22	15.6	—	22.3	15.9	15.6	41.5	29.5	7.5	44.7
	1/4	KQ2H12-02GS	19	17.2	18.2	—	28.7	24	17	58.3	46.1	9	24.3
	3/8	KQ2H12-03GS	19	17.2	18.2	—	25.9	20.8	17	58.3	46.1	9	25.2
	1/2	KQ2H12-04GS	22	22	18.2	—	22.3	15.9	17	58.3	58.3	9	37.7
ø16	3/8	KQ2H16-03GS	24	22	23.6	—	33.1	28	20.6	81	67	11	42.4
	1/2	KQ2H16-04GS	24	22	23.6	—	32.1	25.7	20.6	113	67	13	44.6

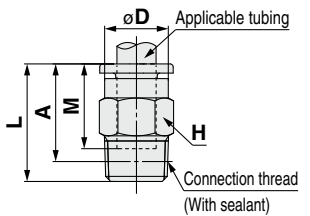

Release button dimensions

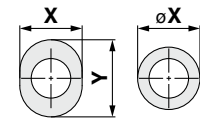

Applicable tubing O.D.: ø4, ø6

\*1: Reference dimensions after installation of R thread

# Metric Size Stainless Steel **KQ2-G Series**

Applicable Tubing: Metric Size, Connection Thread: M, R, Rc

## Dimensions

### Hexagon Socket Head Male Connector: KQ2S-G (Gasket seal)

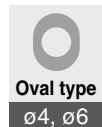

Applicable tubing O.D. [mm]	Connection thread M	Model	H (Width across flats)	øD	Release button dimensions		L1	L2	A	M	Effective area [mm <sup>2</sup> ]		Min. port size	Weight [g]
					X	Y					Nylon	Urethane		
ø4	M5 x 0.8	KQ2S04-M5G1	2.5	8	7.7	10	18.6	15.8	15.6	13.3	4	4	2.5	3
ø6	M5 x 0.8	KQ2S06-M5G1	2.5	10	9.7	12	19.5	17.8	16.5	13.3	4	4	2.5	3.5

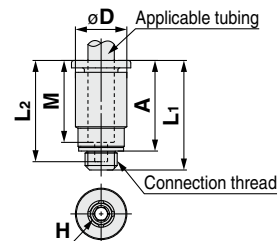

Release button dimensions

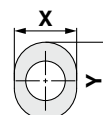

### Hexagon Socket Head Male Connector: KQ2S-G (Sealant)

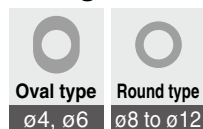

Applicable tubing O.D. [mm]	Connection thread R	Model	H (Width across flats)	øD	Release button dimensions		L1	L2	A*1	M	Effective area [mm <sup>2</sup> ]		Min. port size	Weight [g]
					øX (X)	Y					Nylon	Urethane		
ø4	1/8	KQ2S04-01GS1	3	9.8	7.7	10	19.7	18.8	16.6	13.3	4.1	3.6	3.1	8.1
ø6	1/8	KQ2S06-01GS1	4	10	9.7	12	20	18.8	16.9	13.3	10	9.9	4.1	6.5
	1/4	KQ2S06-02GS1	4	13.8	9.7	12	19.8	18.8	15.1	13.3	10.7	10	4.1	13.4
ø8	1/8	KQ2S08-01GS	5	13	13	—	22.9	19.7	19.8	14.2	17.2	16.2	5.1	10.2
	1/4	KQ2S08-02GS	6	14	13	—	23.2	19.5	18.5	14.2	23.3	16.2	6.1	14.3
	3/8	KQ2S08-03GS	6	17	13	—	20.7	19.7	15.6	14.2	23.3	16.2	6.1	21.1
ø10	1/8	KQ2S10-01GS	5	15	15.6	—	24.3	21.1	21.2	15.6	17.2	16.2	5.1	12
	1/4	KQ2S10-02GS	8	15	15.6	—	24.6	20.1	19.9	15.6	39	26.6	8.1	12.4
	3/8	KQ2S10-03GS	8	17	15.6	—	25.1	20.1	20	15.6	39	26.6	8.1	23.2
	1/2	KQ2S10-04GS	8	22	15.6	—	21.1	20.1	14.7	15.6	39	26.6	8.1	37.4
ø12	1/4	KQ2S12-02GS	8	18	18.2	—	29	21.5	24.3	17	46	44.5	8.1	21
	3/8	KQ2S12-03GS	10	18	18.2	—	26.4	21.8	21.3	17	60	44.5	10.1	21.2
	1/2	KQ2S12-04GS	10	22	18.2	—	22.8	21.8	16.4	17	60	44.5	10.1	30.5

\*1: Reference dimensions after installation of R thread

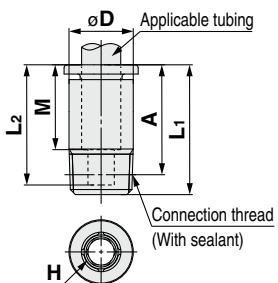

Release button dimensions

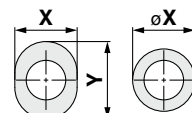

Applicable tubing O.D.: ø4, ø6

### Female Connector: KQ2F-G

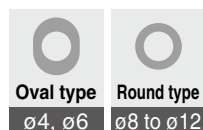

Applicable tubing O.D. [mm]	Connection thread Rc	Model	H (Width across flats)	øD	Release button dimensions		L1	L2	M	Effective area [mm <sup>2</sup> ]		Min. port size	Weight [g]
					øX (X)	Y				Nylon	Urethane		
ø4	1/8	KQ2F04-01G1	14	7.9	7.7	10	24.1	8.5	13.3	5.6	4	3	12
	1/4	KQ2F04-02G1	17	7.9	7.7	10	29	12.9	13.3	5.6	4	3	21.5
ø6	1/8	KQ2F06-01G1	14	9.9	9.7	12	23.6	8.5	13.3	13.1	10.4	4.5	12.2
	1/4	KQ2F06-02G1	17	9.9	9.7	12	28.5	12.9	13.3	13.1	10.4	4.5	21.6
	3/8	KQ2F06-03G1	19	9.9	9.7	12	29.9	12.7	13.3	13.1	10.4	4.5	22.7
ø8	1/8	KQ2F08-01G	14	12.4	13	—	24.1	8.5	14.2	26.1	18	6	12.9
	1/4	KQ2F08-02G	17	12.4	13	—	29	12.2	14.2	26.1	18	6	22.1
	3/8	KQ2F08-03G	19	12.4	13	—	30.4	13.4	14.2	26.1	18	6	30.7
ø10	1/4	KQ2F10-02G	17	14.8	15.6	—	30	12.9	15.6	41.5	29.5	7.5	24.2
	3/8	KQ2F10-03G	19	14.8	15.6	—	31.3	13.3	15.6	41.5	29.5	7.5	25.5
ø12	1/4	KQ2F12-02G	19	17.2	18.2	—	30.9	12.1	17	58.3	46.1	9	32.6
	3/8	KQ2F12-03G	19	17.2	18.2	—	32.3	13.3	17	58.3	46.1	9	27.6
	1/2	KQ2F12-04G	24	17.2	18.2	—	36.3	15.9	17	58.3	46.1	9	46.3

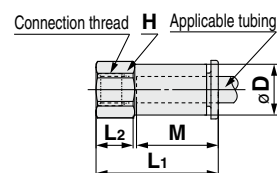

Release button dimensions

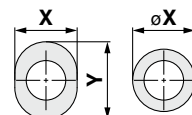

Applicable tubing O.D.: ø4, ø6

# KQ2-G Series

Applicable Tubing: Metric Size, Connection Thread: M, R, Rc

## Dimensions

### Straight Union: KQ2H

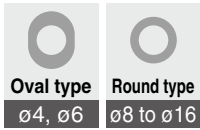

Applicable tubing O.D. [mm]	Model	øD	Release button dimensions		L	M	Effective area [mm <sup>2</sup> ]		Min. port size	Weight [g]
			øX (X)	Y			Nylon	Urethane		
ø4	KQ2H04-00A1	8.2	7.7	10	27.6	13.3	5.6	4	3	1.6
ø6	KQ2H06-00A1	10.4	9.7	12	27.6	13.3	13.1	10.4	4.5	2.1
ø8	KQ2H08-00A	13.2	13	—	29.4	14.2	26.1	18	6	3.7
ø10	KQ2H10-00A	15.9	15.6	—	32.2	15.6	41.5	29.5	7.5	5.5
ø12	KQ2H12-00A	18.5	18.2	—	35	17	58.3	46.1	9	8.2
ø16	KQ2H16-00A	23.8	23.6	—	42.2	20.6	113	67	13	15.2

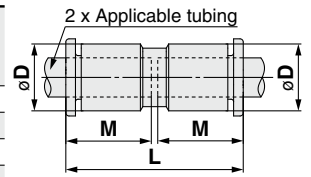

Release button dimensions

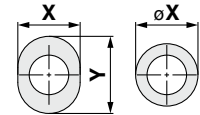

Applicable tubing O.D.: ø4, ø6

### Different Diameter Straight: KQ2H

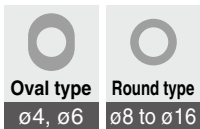

Applicable tubing O.D. [mm]		Model	øD1	Release button dimensions (a)		Release button dimensions (b)		L	M1	M2	Effective area [mm <sup>2</sup> ]		Min. port size	Weight [g]	
(a)	(b)			øX (X)	Y	øD2	øX (X)				Y	Nylon			Urethane
ø4	ø6	KQ2H04-06A1	8.2	7.7	10	10.4	9.7	12	27.6	13.3	13.3	5.6	5.6	3	2
ø4	ø8	KQ2H04-08A1	10.4	7.7	10	13.2	13	—	28.5	13.3	14.2	5.6	5.6	3	3
ø6	ø8	KQ2H06-08A1	10.4	9.7	12	13.2	13	—	28.5	13.3	14.2	13.1	10.4	4.5	2.9
ø6	ø10	KQ2H06-10A1	13.2	9.7	12	15.9	15.6	—	30.8	13.3	15.6	13.1	10.4	4.5	4.9
ø8	ø10	KQ2H08-10A	13.2	13	—	15.9	15.6	—	30.8	14.2	15.6	26.1	18	6	4.9
ø8	ø12	KQ2H08-12A	15.9	13	—	18.5	18.2	—	33.6	14.2	17	26.1	18	6	7.5
ø10	ø12	KQ2H10-12A	15.9	15.6	—	18.5	18.2	—	33.6	15.6	17	41.5	29.5	7.5	7.2
ø12	ø16	KQ2H12-16A	18.5	18.2	—	23.8	23.6	—	38.6	17	20.6	58.3	46.1	9	12.4

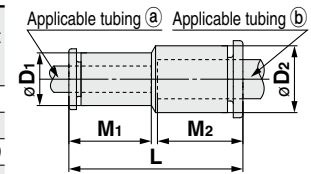

Release button dimensions

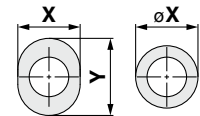

Applicable tubing O.D.: ø4, ø6



# Metric Size Stainless Steel **KQ2-G Series**

Applicable Tubing: Metric Size, Connection Thread: M, R, Rc

## Dimensions

### Male Elbow: KQ2L-G (Gasket seal)

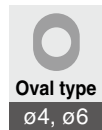

Applicable tubing O.D. [mm]	Connection thread	Model	H (Width across flats)	øD1	Release button dimensions		øD2	L1	L2	A	M	Effective area [mm <sup>2</sup> ]		Min. port size	Weight [g]	With a rib
					øX	Y						Nylon	Urethane			
ø4	M5 x 0.8	KQ2L04-M5G1	7	8.2	7.7	10	7	15.4	14.8	15.9	13.3	3.5	3.5	2.5	3.1	●
ø6	M5 x 0.8	KQ2L06-M5G1	7	10.4	9.7	12	7	14.5	16.5	18.7	13.3	3.5	3.5	2.5	3.2	●

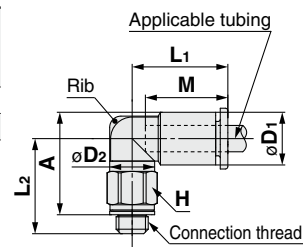

Release button dimensions

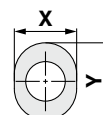

### Male Elbow: KQ2L-G (Sealant)

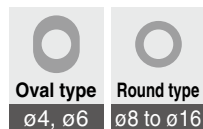

Applicable tubing O.D. [mm]	Connection thread	Model	H (Width across flats)	øD1	Release button dimensions		øD2	L1	L2	A*1	M	Effective area [mm <sup>2</sup> ]		Min. port size	Weight [g]	With a rib
					øX	Y						Nylon	Urethane			
ø4	1/8	KQ2L04-01GS1	10	8.2	7.7	10	10	14.8	16.2	17.2	13.3	4.6	3.3	3	4.8	●
	1/4	KQ2L04-02GS1	14	8.2	7.7	10	10	14.8	21.7	21.1	13.3	4.6	3.3	3	14.3	●
ø6	1/8	KQ2L06-01GS1	10	10.4	9.7	12	10	15.5	17.3	19.4	13.3	11.4	9	4.5	5.2	—
	1/4	KQ2L06-02GS1	14	10.4	9.7	12	10	15.5	22.8	23.3	13.3	11.4	9	4.5	14.7	—
	3/8	KQ2L06-03GS1	17	10.4	9.7	12	10	15.5	24.1	24.2	13.3	11.4	9	4.5	26.5	—
ø8	1/8	KQ2L08-01GS	10	13.2	13	—	10	16.4	18.7	22.2	14.2	11.4	11.4	4.5	6.1	●
	1/8	KQ2L08-01GQS <sup>*2</sup>	12	13.2	13	—	12	17.2	23.5	27.0	14.2	21.6	14.9	6	9.3	●
	1/4	KQ2L08-02GS	14	13.2	13	—	12	17.2	25.4	27.3	14.2	21.6	14.9	6	17.7	●
	3/8	KQ2L08-03GS	17	13.2	13	—	12	17.2	25.5	27.0	14.2	21.6	14.9	6	24.7	●
ø10	1/8	KQ2L10-01GS	12	15.9	15.6	—	12	18.6	23.6	28.4	15.6	21.6	14.9	6	11.1	●
	1/4	KQ2L10-02GS	17	15.9	15.6	—	17	19.3	28.7	31.9	15.6	35.2	25	7.5	21.7	●
	3/8	KQ2L10-03GS	17	15.9	15.6	—	17	19.3	29.6	32.4	15.6	35.2	25	7.5	22.2	●
ø12	1/2	KQ2L10-04GS	22	15.9	15.6	—	17	19.3	33.6	35.1	15.6	35.2	25	7.5	44.6	●
	1/4	KQ2L12-02GS	17	18.5	18.2	—	17	21.5	30.0	34.5	17	50.2	39.7	9	23.5	●
	3/8	KQ2L12-03GS	17	18.5	18.2	—	17	21.5	30.9	35.0	17	50.2	39.7	9	24.1	●
ø16	1/2	KQ2L12-04GS	22	18.5	18.2	—	17	21.5	34.9	37.7	17	50.2	39.7	9	46.5	●
	3/8	KQ2L16-03GS	22	23.8	23.6	—	21	27.1	35.4	42.2	20.6	71	58.9	11	40.8	—
1/2	KQ2L16-04GS	22	23.8	23.6	—	21	27.1	34.1	39.6	20.6	100	58.9	13	44.5	—	

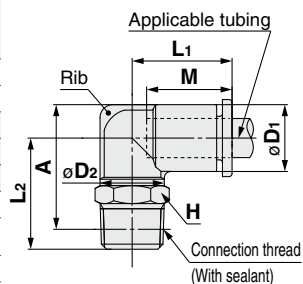

Release button dimensions

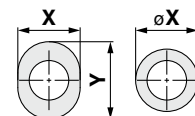

Applicable tubing O.D.: ø4, ø6

\*1: Reference dimensions after installation of R thread

\*2: For details, refer to page 19.

# KQ2-G Series

Applicable Tubing: Metric Size, Connection Thread: M, R, Rc

## Dimensions

### Branch Male Elbow: KQ2LU-G (Gasket seal)



Applicable tubing O.D. (mm)	Connection thread	Model	H (Width across flats)	øD	Release button dimensions		L1	L2	L3	A	M	P	øO	øN	Q1	Q2	Effective area (mm <sup>2</sup> )		Min. port size	Weight (g)
					øX												Nylon	Urethane		
ø4	M5 x 0.8	KQ2LU04-M5G	10	8.2	7.7	15.8	20.7	24.8	21.8	13.3	8.2	6	3.2	15.8	7.9	4.3	4.1	1.8	6.9	
ø6	M5 x 0.8	KQ2LU06-M5G	12	10.4	9.7	16.5	21.4	26.6	23.6	13.3	10.4	6	3.2	16.5	10	4.3	4.3	1.8	10.3	

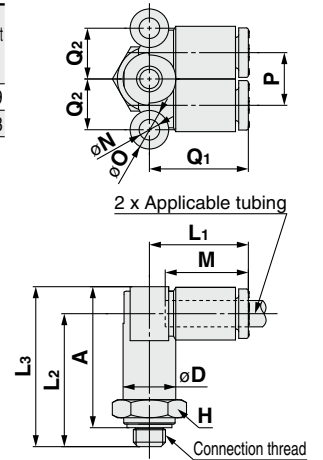

Release button dimensions

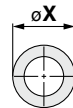

### Branch Male Elbow: KQ2LU-G (Sealant)

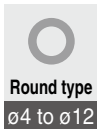

Applicable tubing O.D. (mm)	Connection thread	Model	H (Width across flats)	øD	Release button dimensions		L1	L2	L3	A*1	M	P	øO	øN	Q1	Q2	Effective area (mm <sup>2</sup> )		Min. port size	Weight (g)
					øX												Nylon	Urethane		
ø4	1/8	KQ2LU04-01GS	10	8.2	7.7	15.8	23.3	27.4	24.3	13.3	8.2	6	3.2	15.8	7.9	6	4.1	3	9.5	
	1/4	KQ2LU04-02GS	14	8.2	7.7	15.8	27.7	31.8	27.1	13.3	8.2	6	3.2	15.8	7.9	6	4.1	3	19.3	
ø6	1/8	KQ2LU06-01GS	12	10.4	9.7	16.6	24	29.2	26.1	13.3	10.4	6	3.2	16.5	10	13.9	11	4.5	10.6	
	1/4	KQ2LU06-02GS	14	10.4	9.7	16.5	28.4	33.6	28.9	13.3	10.4	6	3.2	16.5	10	13.9	11	4.5	19.5	
ø8	3/8	KQ2LU06-03GS	17	10.4	9.7	16.5	29.8	35	29.9	13.3	10.4	6	4.2	16.5	10	13.9	11	4.5	31.5	
	1/8	KQ2LU08-01GS	14	13.2	13	18.2	25.7	32.3	29.2	14.2	13.2	8	4.2	18.2	13.1	26.3	18.2	6	16.4	
ø10	1/4	KQ2LU08-02GS	14	13.2	13	18.2	30.1	36.7	32	14.2	13.2	8	4.2	18.2	13.1	26.3	18.2	6	21.5	
	3/8	KQ2LU08-03GS	17	13.2	13	18.2	31.5	38.1	33	14.2	13.2	8	4.2	18.2	13.1	26.3	18.2	6	33.3	
ø12	1/4	KQ2LU10-02GS	17	15.9	15.6	20.3	32.2	40.2	35.5	15.6	15.9	8	4.2	20.3	15.9	40.8	29	7.5	26.6	
	3/8	KQ2LU10-03GS	17	15.9	15.6	20.3	33.6	41.6	36.5	15.6	15.9	8	4.2	20.3	15.9	40.8	29	7.5	34.4	
ø12	1/2	KQ2LU10-04GS	22	15.9	15.6	20.3	37.8	45.8	39.4	17	15.9	8	4.2	20.3	15.9	40.8	29	7.5	62.3	
	3/8	KQ2LU12-03GS	19	22.5	18.2	22.5	34.4	43.6	38.9	17	18.5	8	4.2	22.5	17.9	57.2	45.2	9	37.7	
ø12	1/2	KQ2LU12-04GS	22	22.5	18.2	22.5	40	49.2	42.8	20.6	18.5	8	4.2	22.5	17.9	57.2	45.2	9	62.7	

\*1: Reference dimensions after installation of R thread

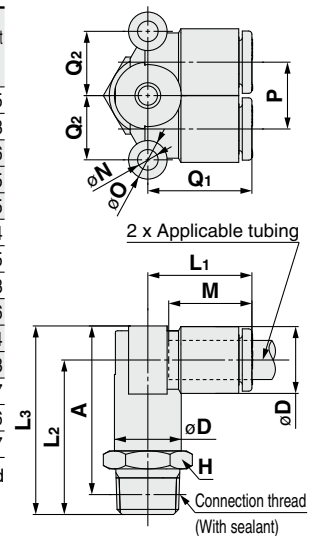

Release button dimensions

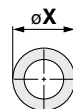

# Metric Size Stainless Steel **KQ2-G Series** One-touch Fittings

Applicable Tubing: Metric Size, Connection Thread: M, R, Rc

## Dimensions

### Universal Male Elbow: KQ2V-G (Gasket seal)

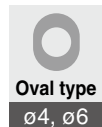

Applicable tubing O.D. [mm]	Connection thread	Model	H (Width across flats)	øD1	Release button dimensions		øD2	L1	L2	L3	A	M	Effective area [mm <sup>2</sup> ]		Min. port size	Weight [g]
					X	Y							Nylon	Urethane		
ø4	M5 x 0.8	KQ2V04-M5G1	8	8.2	7.7	10	9.8	17.5	10.9	18.4	14.9	13.3	2.9	2.9	2.5	5.4
ø6	M5 x 0.8	KQ2V06-M5G1	8	10.4	9.7	12	9.8	18.3	10.9	18.4	14.9	13.3	3.8	3.8	2.5	5.7

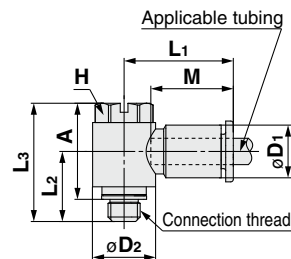

Release button dimensions

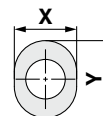

### Universal Male Elbow: KQ2V-G (Sealant)

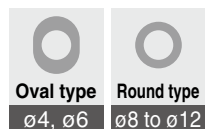

Applicable tubing O.D. [mm]	Connection thread	Model	H (Width across flats)	øD1	Release button dimensions		øD2	L1	L2	L3	A*1	M	Effective area [mm <sup>2</sup> ]		Min. port size	Weight [g]
					øX (X)	Y							Nylon	Urethane		
ø4	1/8	KQ2V04-01GS1	8	8.2	7.7	10	13.4	19.3	13.7	25.6	22.5	13.3	2.9	2.9	3	13.2
ø6	1/8	KQ2V06-01GS1	8	10.4	9.7	12	13.4	20.5	13.7	25.6	22.5	13.3	7.5	5.9	4.5	13.5
	1/4	KQ2V06-02GS1	10	10.4	9.7	12	15.3	19.9	17.9	30.5	25.8	13.3	7.5	5.9	4.5	24.9
ø8	1/8	KQ2V08-01GS	12	13.2	13	—	17.6	23.5	15.1	27.6	24.5	14.2	16	11.2	6	22.6
	1/4	KQ2V08-02GS	12	13.2	13	—	17.6	23.5	18.5	31	26.3	14.2	16	11.2	6	29.1
ø10	3/8	KQ2V08-03GS	14	13.2	13	—	20.6	23.1	19.5	35.3	30.2	14.2	16	11.2	6	44.4
	1/4	KQ2V10-02GS	14	15.9	15.6	—	20.6	25.9	19.9	34.9	30.2	15.6	27	20.3	7.5	38.1
ø12	3/8	KQ2V10-03GS	14	15.9	15.6	—	20.6	25.9	20.3	35.3	30.2	15.6	27	20.3	7.5	45.7
	3/8	KQ2V12-03GS	17	18.5	18.2	—	25.2	28.5	21.4	37.6	32.5	17	39	30.8	9	59.6
ø12	1/2	KQ2V12-04GS	17	18.5	18.2	—	25.2	28.5	24.6	40.8	34.4	17	39	30.8	9	78.2

\*1: Reference dimensions after installation of R thread

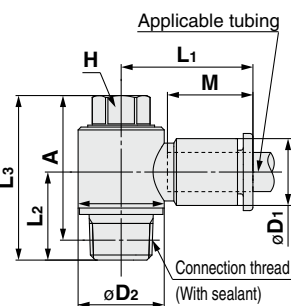

Release button dimensions

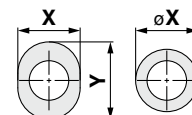

Applicable tubing O.D.: ø4, ø6

### Union Elbow: KQ2L

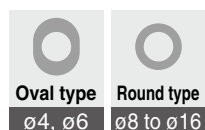

Applicable tubing O.D. [mm]	Model	øD	Release button dimensions		L	Q	M	øO	øN	Effective area [mm <sup>2</sup> ]		Min. port size	Weight [g]
			øX (X)	Y						Nylon	Urethane		
ø4	KQ2L04-00A1	8.2	7.7	10	15.3	5.7	13.3	6	3.2	4.2	4.2	3	1.9
ø6	KQ2L06-00A1	10.4	9.7	12	16.3	6.8	13.3	6	3.2	11.4	9	4.5	2.7
ø8	KQ2L08-00A	13.2	13	—	18.2	8.4	14.2	8	4.2	21.6	14.9	6	4.7
ø10	KQ2L10-00A	15.9	15.6	—	20.6	9.6	15.6	8	4.2	35.2	25	7.5	7.1
ø12	KQ2L12-00A	18.5	18.2	—	23	10.7	17	8	4.2	50.2	39.7	9	10.3
ø16	KQ2L16-00A	23.8	23.6	—	28.6	13.4	20.6	8	4.2	100	58.9	13	19.7

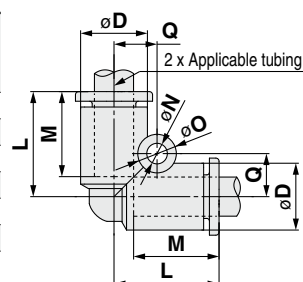

Release button dimensions

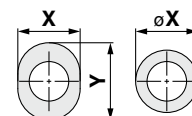

Applicable tubing O.D.: ø4, ø6

# KQ2-G Series

Applicable Tubing: Metric Size, Connection Thread: M, R, Rc

## Dimensions

### Branch Union Elbow: KQ2LU



Applicable tubing O.D. [mm]	Model	øD	L1	L2	Q1	Q2	M	P	øO	øN	Effective area [mm <sup>2</sup> ]		Min. port size	Weight [g]
											Nylon	Urethane		
ø4	KQ2LU04-00A	8.2	15.8	19.9	15.8	7.9	13.3	8.2	6	3.2	6	4.1	3	3.1
ø6	KQ2LU06-00A	10.4	16.5	21.7	16.5	10	13.3	10.4	6	3.2	13.9	11	4.5	4.4
ø8	KQ2LU08-00A	13.2	18.2	24.8	18.2	13.1	14.2	13.2	8	4.2	26.3	18.2	6	8
ø10	KQ2LU10-00A	15.9	20.3	28.3	20.3	15.9	15.6	15.9	8	4.2	40.8	29	7.5	12.2
ø12	KQ2LU12-00A	18.5	22.5	31.7	22.5	17.9	17	18.5	8	4.2	57.2	45.2	9	18.1

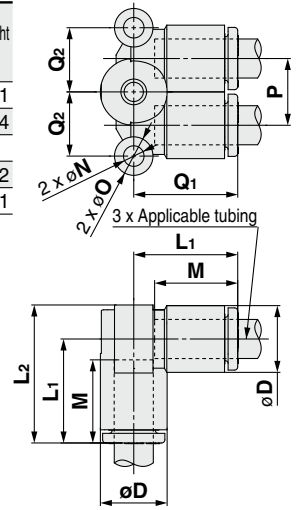

### Plug-in Elbow: KQ2L

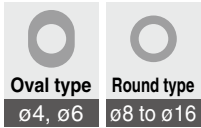

Applicable tubing O.D. [mm]	Applicable fitting size ød	Model	øD1	Release button dimensions		øD2	L1	L2	A	M	Effective area [mm <sup>2</sup> ]		Min. port size	Weight [g]
				øX (X)	Y						Nylon	Urethane		
ø4	ø4	KQ2L04-99A1	8.2	7.7	10	7.2	14.5	21.1	11.9	13.3	4.2	4.2	2.5	1.2
ø6	ø6	KQ2L06-99A1	10.4	9.7	12	8	15.3	22.3	14.2	13.3	9	9	4	1.8
ø8	ø8	KQ2L08-99A	13.2	13	—	10	17.2	26.2	18.6	14.2	21.6	14.9	6	3
ø10	ø10	KQ2L10-99A	15.9	15.6	—	12	19.3	28.2	20.5	15.6	35.2	25	7.5	4.7
ø12	ø12	KQ2L12-99A	18.5	18.2	—	14	21.5	31	23.2	17	50.2	39.7	9	7
ø16	ø16	KQ2L16-99A	23.8	23.6	—	20	27.1	36.8	28.1	20.6	100	58.9	13	13.7

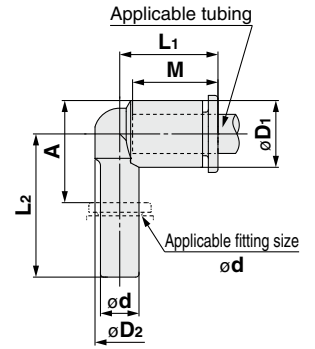

#### Release button dimensions

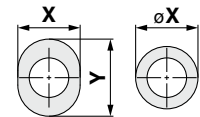

Applicable tubing O.D.: ø4, ø6

# Metric Size Stainless Steel **KQ2-G Series** One-touch Fittings

Applicable Tubing: Metric Size, Connection Thread: M, R, Rc

## Dimensions

### Extended Male Elbow: KQ2W-G (Gasket seal)

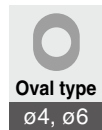

Applicable tubing O.D. [mm]	Connection thread	Model	H (Width across flats)	øD1	Release button dimensions		øD2	L1	L2	A	M	Effective area [mm <sup>2</sup> ]		Min. port size	Weight [g]	With a rib
					øX	Y						Nylon	Urethane			
ø4	M5 x 0.8	KQ2W04-M5G1	7	8.2	7.7	10	7	15.4	25.7	26.8	13.3	3	3	2.5	5.8	●
ø6	M5 x 0.8	KQ2W06-M5G1	7	10.4	9.7	12	7	14.5	27.4	29.6	13.3	3	3	2.5	5.9	●

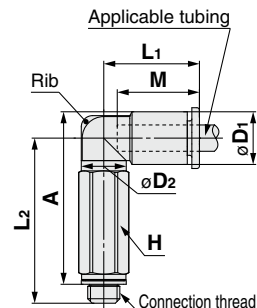

Release button dimensions

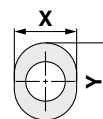

### Extended Male Elbow: KQ2W-G (Sealant)

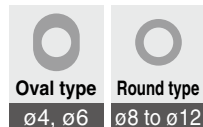

Applicable tubing O.D. [mm]	Connection thread	Model	H (Width across flats)	øD1	Release button dimensions		øD2	L1	L2	A*1	M	Effective area [mm <sup>2</sup> ]		Min. port size	Weight [g]	With a rib
					øX (X)	Y						Nylon	Urethane			
ø4	1/8	KQ2W04-01GS1	10	8.2	7.7	10	10	14.8	29.9	30.9	13.3	4	4	3	11	●
	1/4	KQ2W04-02GS1	14	8.2	7.7	10	10	14.8	33.3	32.7	13.3	4	4	3	27.5	●
ø6	1/8	KQ2W06-01GS1	10	10.4	9.7	12	10	15.5	31	33.1	13.3	10.9	8.6	4.5	11.4	—
	1/4	KQ2W06-02GS1	14	10.4	9.7	12	10	15.5	34.4	34.9	13.3	10.9	8.6	4.5	28	—
	3/8	KQ2W06-03GS1	17	10.4	9.7	12	10	15.5	35.7	35.8	13.3	10.9	8.6	4.5	47.4	—
ø8	1/8	KQ2W08-01GS	10	13.2	13	—	10	16.4	32.4	35.9	14.2	10.9	10.9	4.5	12.2	●
	1/8	KQ2W08-01GQS <sup>*2</sup>	12	13.2	13	—	12	17.2	42.4	45.9	14.2	20.5	14.2	6	23.7	●
	1/4	KQ2W08-02GS	14	13.2	13	—	12	17.2	39.1	41	14.2	20.5	14.2	6	40	●
ø10	3/8	KQ2W08-03GS	17	13.2	13	—	12	17.2	39.2	40.7	14.2	20.5	14.2	6	47	●
	1/4	KQ2W10-02GS	17	15.9	15.6	—	17	19.3	52.9	56.2	15.6	33.5	23.8	7.5	59	●
	3/8	KQ2W10-03GS	17	15.9	15.6	—	17	19.3	48.5	51.4	15.6	33.5	23.8	7.5	51.3	●
ø12	1/2	KQ2W10-04GS	22	15.9	15.6	—	17	19.3	52.5	54.1	15.6	33.5	23.8	7.5	92	●
	1/4	KQ2W12-02GS	17	18.5	18.2	—	17	21.5	54.2	58.8	17	47.7	37.7	9	60.7	●
	3/8	KQ2W12-03GS	17	18.5	18.2	—	17	21.5	49.8	54	17	47.7	37.7	9	53.2	●
1/2	KQ2W12-04GS	22	18.5	18.2	—	17	21.5	53.8	56.7	17	47.7	37.7	9	93.9	●	

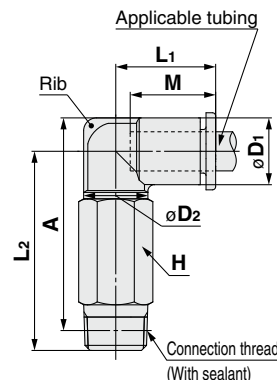

Release button dimensions

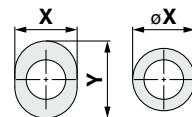

Applicable tubing O.D.: ø4, ø6

\*1: Reference dimensions after installation of R thread

\*2: For details, refer to page 19.

# KQ2-G Series

Applicable Tubing: Metric Size, Connection Thread: M, R, Rc

## Dimensions

### Male Branch Tee: KQ2T-G (Gasket seal)

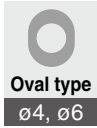

Applicable tubing O.D. [mm]	Connection thread M	Model	H (Width across flats)	øD1	Release button dimensions		øD2	L1	L2	A	M	Effective area [mm <sup>2</sup> ]		Min. port size	Weight [g]
					X	Y						Nylon	Urethane		
ø4	M5 x 0.8	KQ2T04-M5G1	7	8.2	7.7	10	7	15.4	14.8	15.9	13.3	4.5	4.5	2.5	3.9
ø6	M5 x 0.8	KQ2T06-M5G1	7	10.4	9.7	12	7	14.5	16.5	18.7	13.3	4.5	4.5	2.5	4.4

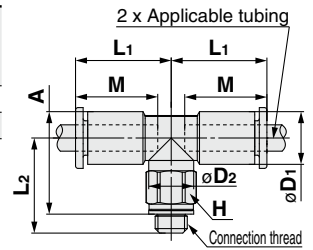

Release button dimensions

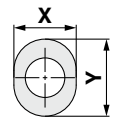

### Male Branch Tee: KQ2T-G (Sealant)

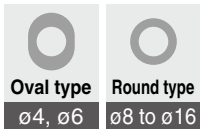

Applicable tubing O.D. [mm]	Connection thread R	Model	H (Width across flats)	øD1	Release button dimensions		øD2	L1	L2	A*1	M	Effective area [mm <sup>2</sup> ]		Min. port size	Weight [g]
					øX (X)	Y						Nylon	Urethane		
ø4	1/8	KQ2T04-01GS1	10	8.2	7.7	10	10	14.8	16.2	17.2	13.3	6	4.1	3	5.5
	1/4	KQ2T04-02GS1	14	8.2	7.7	10	10	14.8	21.7	21.1	13.3	6	4.1	3	15
ø6	1/8	KQ2T06-01GS1	10	10.4	9.7	12	10	15.5	17.3	19.4	13.3	13.9	11	4.5	6.1
	1/4	KQ2T06-02GS1	14	10.4	9.7	12	10	15.5	22.8	23.3	13.3	13.9	11	4.5	15.6
	3/8	KQ2T06-03GS1	17	10.4	9.7	12	10	15.5	24.1	24.2	13.3	13.9	11	4.5	27.4
ø8	1/8	KQ2T08-01GS	10	13.2	13	—	10	16.4	18.7	22.2	14.2	14	14	4.5	7.9
	1/8	KQ2T08-01GQS <sup>*2</sup>	12	13.2	13	—	12	17.2	23.5	27	14.2	26.3	18.2	6	11
	1/4	KQ2T08-02GS	14	13.2	13	—	12	17.2	25.4	27.3	14.2	26.3	18.2	6	19.4
	3/8	KQ2T08-03GS	17	13.2	13	—	12	17.2	25.5	27	14.2	26.3	18.2	6	26.5
ø10	1/8	KQ2T10-01GS	12	15.9	15.6	—	12	18.6	23.5	28.4	15.6	21.6	14.9	6	13.9
	1/4	KQ2T10-02GS	17	15.9	15.6	—	17	19.3	28.6	31.9	15.6	35.2	25	7.5	24.3
	3/8	KQ2T10-03GS	17	15.9	15.6	—	17	19.3	29.5	32.4	15.6	35.2	25	7.5	24.8
ø12	1/2	KQ2T10-04GS	22	15.9	15.6	—	17	19.3	33.5	35.1	15.6	35.2	25	7.5	47.3
	1/4	KQ2T12-02GS	17	18.5	18.2	—	17	21.5	29.9	34.5	17	57.2	45.2	9	27.3
ø12	3/8	KQ2T12-03GS	17	18.5	18.2	—	17	21.5	30.8	35	17	57.2	45.2	9	28
	1/2	KQ2T12-04GS	22	18.5	18.2	—	17	21.5	34.8	37.7	17	57.2	45.2	9	50.4
ø16	3/8	KQ2T16-03GS	22	23.8	23.6	—	21	27.1	35.4	42.2	20.6	71	58.9	11	47.7
	1/2	KQ2T16-04GS	22	23.8	23.6	—	21	27.1	34.1	39.6	20.6	100	58.9	13	51.4

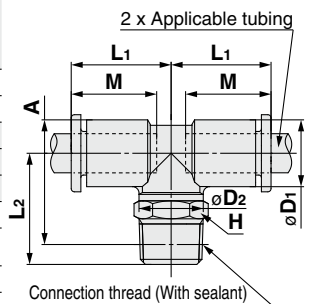

Release button dimensions

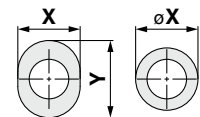

Applicable tubing O.D.: ø4, ø6

\*1: Reference dimensions after installation of R thread  
\*2: For details, refer to page 19.

### Union Tee: KQ2T

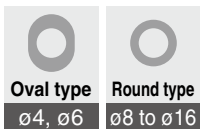

Applicable tubing O.D. [mm]	Model	øD	Release button dimensions		L1	L2	M	Q	øO	øN	Effective area [mm <sup>2</sup> ]		Min. port size	Weight [g]
			øX (X)	Y							Nylon	Urethane		
ø4	KQ2T04-00A1	8.2	7.7	10	15.3	19.4	13.3	5.7	6	3.2	6.4	4.4	3	2.8
ø6	KQ2T06-00A1	10.4	9.7	12	16.3	21.5	13.3	6.8	6	3.2	13.4	10.6	4.5	3.8
ø8	KQ2T08-00A	13.2	13	—	18.2	24.8	14.2	8.4	8	4.2	25.6	17.7	6	7
ø10	KQ2T10-00A	15.9	15.6	—	20.6	28.6	15.6	9.6	8	4.2	40	28.4	7.5	11
ø12	KQ2T12-00A	18.5	18.2	—	23	32.3	17	10.7	8	4.2	57.4	45.4	9	15.7
ø16	KQ2T16-00A	23.8	23.6	—	28.6	40.5	20.6	13.4	8	4.2	100	58.9	13	29.8

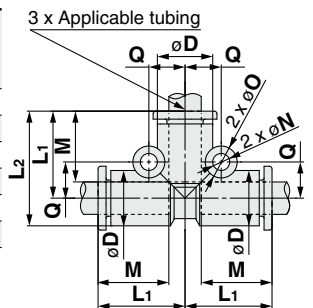

Release button dimensions

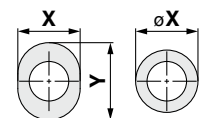

Applicable tubing O.D.: ø4, ø6



# Metric Size Stainless Steel **KQ2-G Series**

Applicable Tubing: Metric Size, Connection Thread: M, R, Rc

## Dimensions

### Different Diameter Tee: KQ2T

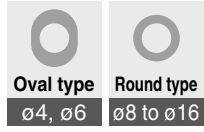

Applicable tubing O.D. [mm]	Model	Release button dimensions (a)		Release button dimensions (b)		L <sub>1</sub>	L <sub>2</sub>	L <sub>3</sub>	M <sub>1</sub>	M <sub>2</sub>	Q <sub>1</sub>	Q <sub>2</sub>	Mounting hole		Effective area [mm <sup>2</sup> ]		Min. port size	Weight [g]			
		øD <sub>1</sub>	øX (X)	Y	øD <sub>2</sub>								øX (X)	Y	øO	øN			Nylon	Urethane	
ø4 ø6	KQ2T04-06A1	10.4	7.7	10	8.2	9.7	12	15.3	16.3	19.4	13.3	13.3	5.7	6.8	6	3.2	10.4	7.1	6.6	3	3.3
ø4 ø8	KQ2T04-08A1	13.2	7.7	10	10.4	13	—	17.2	17.3	22.4	14.2	13.3	7.3	8.4	8	4.2	13.2	7.1	6.6	3	5.5
ø6 ø8	KQ2T06-08A1	13.2	9.7	12	10.4	13	—	17.2	17.3	22.4	14.2	13.3	7.3	8.4	8	4.2	13.2	16.4	16.4	4.5	5.3
ø6 ø10	KQ2T06-10A1	15.9	9.7	12	13.2	15.6	—	19.6	19.2	26.2	15.6	13.3	8.4	9.6	8	4.2	15.9	16.4	16.4	4.5	12.7
ø8 ø10	KQ2T08-10A	15.9	15.6	—	13.2	13	—	19.6	19.2	26.2	15.6	14.2	8.4	9.6	8	4.2	15.9	36	27.2	6	8.3
ø8 ø12	KQ2T08-12A	18.5	18.2	—	15.9	13	—	22	21.6	30	17	14.2	9.6	10.7	8	4.2	18.5	36	27.2	6	12.7
ø10 ø12	KQ2T10-12A	18.5	18.2	—	15.9	15.6	—	22	21.6	30	17	15.6	9.6	10.7	8	4.2	18.5	56	44.5	7.5	12.2
ø12 ø16	KQ2T12-16A	23.8	23.6	—	18.5	18.2	—	26.6	25	35.9	20.6	17	10.7	13.4	8	4.2	23.8	108.5	74	9	20.1

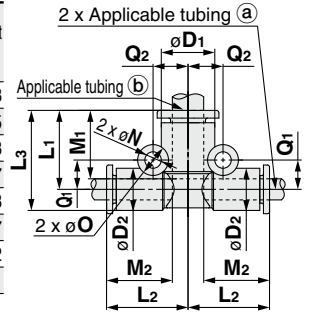

Release button dimensions

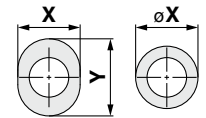

Applicable tubing O.D.: ø4, ø6

### Male Run Tee: KQ2Y-G (Gasket seal)

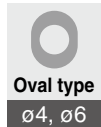

Applicable tubing O.D. [mm]	Connection thread M	Model	H (Width across flats)	øD <sub>1</sub>	Release button dimensions		øD <sub>2</sub>	L <sub>1</sub>	L <sub>2</sub>	L <sub>3</sub>	A	M	Effective area [mm <sup>2</sup> ]		Min. port size	Weight [g]
					øX (X)	Y							Nylon	Urethane		
ø4	M5 x 0.8	KQ2Y04-M5G1	7	8.2	7.7	10	7	15.4	14.8	15.4	27.2	13.3	4.5	4.5	2.5	3.9
ø6	M5 x 0.8	KQ2Y06-M5G1	7	10.4	9.7	12	7	16.3	16.5	16.3	29.8	13.3	4.5	4.5	2.5	4.6

2 x Applicable tubing

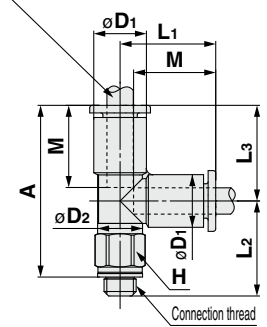

Release button dimensions

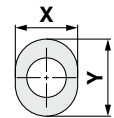

### Male Run Tee: KQ2Y-G (Sealant)

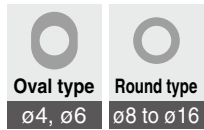

Applicable tubing O.D. [mm]	Connection thread R	Model	H (Width across flats)	øD <sub>1</sub>	Release button dimensions		øD <sub>2</sub>	L <sub>1</sub>	L <sub>2</sub>	L <sub>3</sub>	A*1	M	Effective area [mm <sup>2</sup> ]		Min. port size	Weight [g]
					øX (X)	Y							Nylon	Urethane		
ø4	1/8	KQ2Y04-01GS1	10	8.2	7.7	10	10	15.3	16.2	15.3	28.4	13.3	6.4	4.4	3	5.6
	1/4	KQ2Y04-02GS1	14	8.2	7.7	10	10	15.3	21.7	15.3	32.3	13.3	6.4	4.4	3	15
ø6	1/8	KQ2Y06-01GS1	10	10.4	9.7	12	10	16.3	17.3	16.3	30.5	13.3	13.4	10.6	4.5	6.2
	3/8	KQ2Y06-03GS1	17	10.4	9.7	12	10	16.3	24.1	16.3	35.3	13.3	13.4	10.6	4.5	27.5
ø8	1/8	KQ2Y08-01GS	10	13.2	13	—	10	18.2	18.7	18.2	33.8	14.2	13.4	13.4	4.5	8
	1/8	KQ2Y08-01GS*2	12	13.2	13	—	12	18.2	23.5	18.2	38.7	14.2	25.6	17.7	6	11.1
	1/4	KQ2Y08-02GS	14	13.2	13	—	12	18.2	25.4	18.2	38.9	14.2	25.6	17.7	6	19.5
ø10	3/8	KQ2Y08-03GS	17	13.2	13	—	12	18.2	25.5	18.2	38.6	14.2	25.6	17.7	6	26.5
	1/8	KQ2Y10-01GS	12	15.9	15.6	—	12	20.6	23.5	20.6	41.1	15.6	40	28.4	6	14
	1/4	KQ2Y10-02GS	17	15.9	15.6	—	17	20.6	28.6	20.6	44.6	15.6	40	28.4	7.5	24.5
ø12	3/8	KQ2Y10-03GS	17	15.9	15.6	—	17	20.6	29.5	20.6	45.1	15.6	40	28.4	7.5	25
	1/2	KQ2Y10-04GS	22	15.9	15.6	—	17	20.6	33.5	20.6	47.8	15.6	40	28.4	7.5	47.4
	1/4	KQ2Y12-02GS	17	18.5	18.2	—	17	23	29.9	23	48.3	17	57.4	45.4	9	27.6
ø16	3/8	KQ2Y12-03GS	17	18.5	18.2	—	17	23	30.8	23	48.8	17	57.4	45.4	9	28.2
	1/2	KQ2Y12-04GS	22	18.5	18.2	—	17	23	34.8	23	51.5	17	57.4	45.4	9	50.7
ø16	3/8	KQ2Y16-03GS	22	23.8	23.6	—	21	28.6	35.4	28.6	58.9	20.6	81	60	11	48.3
	1/2	KQ2Y16-04GS	22	23.8	23.6	—	21	28.6	34.1	28.6	56.3	20.6	113	60	13	52

2 x Applicable tubing

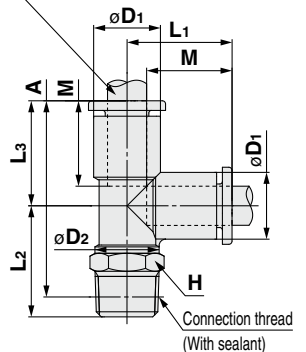

Release button dimensions

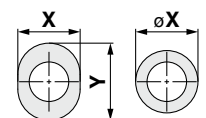

Applicable tubing O.D.: ø4, ø6

\*1: Reference dimensions after installation of R thread  
\*2: For details, refer to page 19.

# KQ2-G Series

Applicable Tubing: Metric Size, Connection Thread: M, R, Rc

## Dimensions

### Male Delta Union: KQ2D-G (Gasket seal)

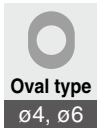

Applicable tubing O.D. [mm]	Connection thread	Model	H (Width across flats)	øD	Release button dimensions		L <sub>1</sub>	L <sub>2</sub>	A	M	Q	øO	øN	Effective area [mm <sup>2</sup> ]		Min. port size	Weight [g]
					X	Y								Nylon	Urethane		
ø4	M5 x 0.8	KQ2D04-M5G1	10	8.2	7.7	10	15.8	20.7	21.8	13.3	5.7	6	3.2	2.2	2.2	1.8	6.6
ø6	M5 x 0.8	KQ2D06-M5G1	12	10.4	9.7	12	16.8	21.7	23.9	13.3	6.7	6	3.2	4.3	4.3	1.8	9.8

Release button dimensions

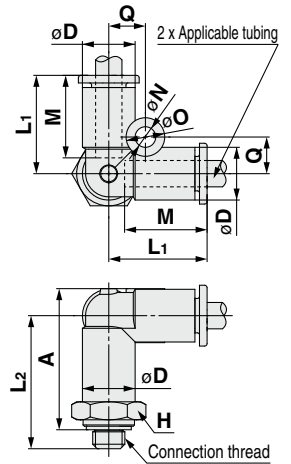
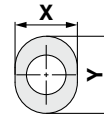

### Male Delta Union: KQ2D-G (Sealant)

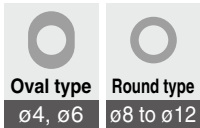

Applicable tubing O.D. [mm]	Connection thread	Model	H (Width across flats)	øD	Release button dimensions		L <sub>1</sub>	L <sub>2</sub>	A*1	M	Q	øO	øN	Effective area [mm <sup>2</sup> ]		Min. port size	Weight [g]
					øX (X)	Y								Nylon	Urethane		
ø4	1/8	KQ2D04-01GS1	10	8.2	7.7	10	15.8	23.3	24.3	13.3	5.7	6	3.2	6	6	3.6	9.2
	1/4	KQ2D04-02GS1	14	8.2	7.7	10	15.8	27.7	27.1	13.3	5.7	6	3.2	6	6	3.6	19
ø6	1/8	KQ2D06-01GS1	12	10.4	9.7	12	16.8	24.3	26.4	13.3	6.7	6	3.2	13.9	11	5.4	10.2
	1/4	KQ2D06-02GS1	14	10.4	9.7	12	16.8	28.7	29.2	13.3	6.7	6	3.2	13.9	11	5.4	19.1
ø8	3/8	KQ2D06-03GS1	17	10.4	9.7	12	16.8	30.1	30.2	13.3	6.7	6	3.2	13.9	11	5.4	31
	1/8	KQ2D08-01GS	14	13.2	13	—	18.8	26.3	29.8	14.2	8.4	8	4.2	26.3	18.2	6	15.3
ø10	1/4	KQ2D08-02GS	14	13.2	13	—	18.8	30.7	32.6	14.2	8.4	8	4.2	26.3	18.2	7.3	20.4
	3/8	KQ2D08-03GS	17	13.2	13	—	18.8	32.1	33.6	14.2	8.4	8	4.2	26.3	18.2	7.3	32.1
ø12	1/4	KQ2D10-02GS	17	15.9	15.6	—	21.2	33.1	36.3	15.6	9.6	8	4.2	40.8	29	9	24.9
	3/8	KQ2D10-03GS	17	15.9	15.6	—	21.2	34.5	37.3	15.6	9.6	8	4.2	40.8	29	9.4	32.7
ø12	1/2	KQ2D10-04GS	22	15.9	15.6	—	21.2	38.7	40.2	15.6	9.6	8	4.2	40.8	29	9.4	60.6
	1/4	KQ2D12-02GS	19	18.5	18.2	—	23.6	35.5	40	17	10.7	8	4.2	57.2	45.2	9	35
ø12	3/8	KQ2D12-03GS	19	18.5	18.2	—	23.6	36.9	41	17	10.7	8	4.2	57.2	45.2	11	38
	1/2	KQ2D12-04GS	22	18.5	18.2	—	23.6	41.1	43.9	17	10.7	8	4.2	57.2	45.2	11.6	60

\*1: Reference dimensions after installation of R thread

Release button dimensions

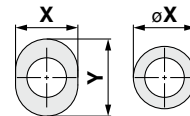

Applicable tubing O.D.: ø4, ø6

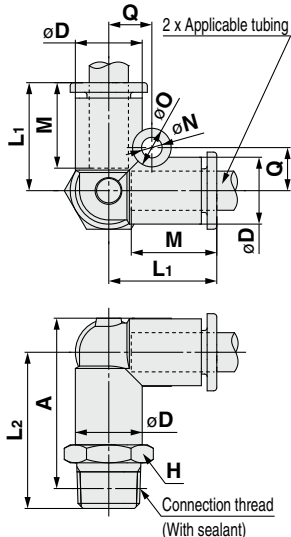

### Delta Union: KQ2D

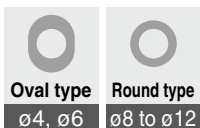

Applicable tubing O.D. [mm]	Model	øD	Release button dimensions		L	M	Q	øO	øN	Effective area [mm <sup>2</sup> ]		Min. port size	Weight [g]
			øX (X)	Y						Nylon	Urethane		
ø4	KQ2D04-00A1	8.2	7.7	10	15.8	13.3	5.7	6	3.2	6	4.1	3	2.7
ø6	KQ2D06-00A1	10.4	9.7	12	16.8	13.3	6.7	6	3.2	13.9	11	4.5	3.8
ø8	KQ2D08-00A	13.2	13	—	18.8	14.2	8.4	8	4.2	26.3	18.2	6	6.8
ø10	KQ2D10-00A	15.9	15.6	—	21.2	15.6	9.6	8	4.2	40.8	29	7.5	10.3
ø12	KQ2D12-00A	18.5	18.2	—	23.6	17	10.7	8	4.2	57.2	45.2	9	15.2

Release button dimensions

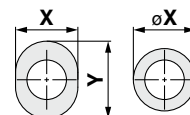

Applicable tubing O.D.: ø4, ø6

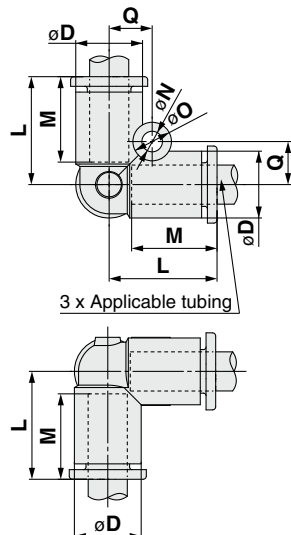

# Metric Size Stainless Steel **KQ2-G Series** One-touch Fittings

Applicable Tubing: Metric Size, Connection Thread: M, R, Rc

## Dimensions

### Branch "Y": KQ2U-G (Gasket seal)



Applicable tubing O.D. [mm]	Connection thread	Model	H (Width across flats)	øD	Release button dimensions øX	L	A	M	P	Q	øO	øN	Effective area [mm <sup>2</sup> ]		Min. port size	Weight [g]
													Nylon	Urethane		
ø4	M5 x 0.8	KQ2U04-M5G	10	8.2	7.7	33.9	30.9	13.3	8.2	5.7	6	3.2	2.2	2.2	1.8	6.7
ø6	M5 x 0.8	KQ2U06-M5G	12	10.4	9.7	35	32	13.3	10.4	6.8	6	3.2	2.2	2.2	1.8	10



Release button dimensions

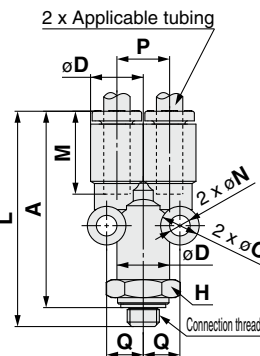
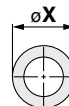

### Branch "Y": KQ2U-G (Sealant)



Applicable tubing O.D. [mm]	Connection thread	Model	H (Width across flats)	øD	Release button dimensions øX	L	A*1	M	P	Q	øO	øN	Effective area [mm <sup>2</sup> ]		Min. port size	Weight [g]
													Nylon	Urethane		
ø4	1/8	KQ2U04-01GS	10	8.2	7.7	36.5	33.4	13.3	8.2	5.7	6	3.2	4.2	4.2	3.6	9.3
	1/4	KQ2U04-02GS	14	8.2	7.7	40.9	36.2	13.3	8.2	5.7	6	3.2	4.2	4.2	3.6	19.1
ø6	1/8	KQ2U06-01GS	12	10.4	9.7	37.6	34.5	13.3	10.4	6.8	6	3.2	13.4	10.6	5.4	10.3
	1/4	KQ2U06-02GS	14	10.4	9.7	42	37.3	13.3	10.4	6.8	6	3.2	13.4	10.6	5.4	19.2
ø8	3/8	KQ2U06-03GS	17	10.4	9.7	43.4	38.3	13.3	10.4	6.8	6	3.2	13.4	10.6	5.4	31.2
	1/8	KQ2U08-01GS	14	13.2	13	40.7	37.6	14.2	13.2	8.7	8	4.2	25.6	17.7	6	15.8
ø8	1/4	KQ2U08-02GS	14	13.2	13	45.1	40.4	14.2	13.2	8.7	8	4.2	25.6	17.7	7.3	20.9
	3/8	KQ2U08-03GS	17	13.2	13	46.5	41.4	14.2	13.2	8.7	8	4.2	25.6	17.7	7.3	32.7
ø10	1/4	KQ2U10-02GS	17	15.9	15.6	49	44.3	15.6	15.9	10.1	8	4.2	40	28.4	9	25.6
	3/8	KQ2U10-03GS	17	15.9	15.6	50.4	45.3	15.6	15.9	10.1	8	4.2	40	28.4	9.4	33.4
ø10	1/2	KQ2U10-04GS	22	15.9	15.6	54.6	48.2	15.6	15.9	10.1	8	4.2	40	28.4	9.4	61.3
	1/4	KQ2U12-02GS	19	18.5	18.2	53	48.3	17	18.5	11.4	8	4.2	57.4	45.4	9	36
ø12	3/8	KQ2U12-03GS	19	18.5	18.2	54.4	49.3	17	18.5	11.4	8	4.2	57.4	45.4	11	38.9
	1/2	KQ2U12-04GS	22	18.5	18.2	58.6	52.2	17	18.5	11.4	8	4.2	57.4	45.4	11.6	61

\*1: Reference dimensions after installation of R thread

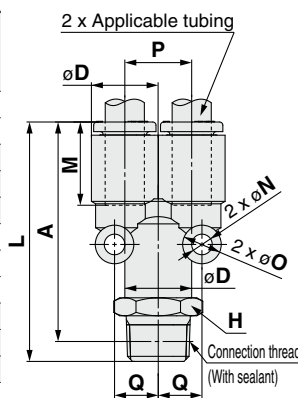

Release button dimensions

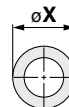

### Double Branch "Y": KQ2UD-G (Sealant)



Applicable tubing O.D. [mm]	Connection thread	Model	H (Width across flats)	øD1	Release button dimensions øX	øD2	L	I	A*1	M	P	Q	øO	øN	Effective area [mm <sup>2</sup> ]		Min. port size	Weight [g]
															Nylon	Urethane		
ø4	1/8	KQ2UD04-01GS	12	8.2	7.7	10.4	36.7	16.6	33.6	13.3	8.2	6.8	6	3.2	4.2	4.2	5.4	11.7
	1/4	KQ2UD04-02GS	14	8.2	7.7	10.4	41.1	16.6	36.4	13.3	8.2	6.8	6	3.2	4.2	4.2	5.4	20.6
ø6	1/8	KQ2UD06-01GS	14	10.4	9.7	13.2	39.5	21	36.4	13.3	10.4	8.2	6	3.2	13.4	10.6	6	16.4
	1/4	KQ2UD06-02GS	14	10.4	9.7	13.2	43.9	21	39.2	13.3	10.4	8.2	6	3.2	13.4	10.6	7.3	21.6

\*1: Reference dimensions after installation of R thread



Release button dimensions

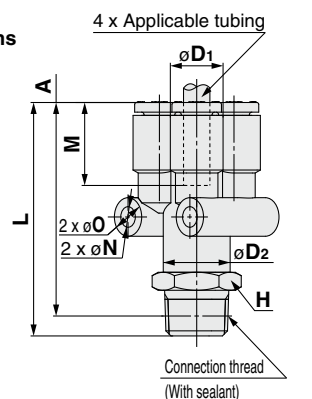
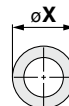

# KQ2-G Series

Applicable Tubing: Metric Size, Connection Thread: M, R, Rc

## Dimensions

### Union "Y": KQ2U



Applicable tubing O.D. [mm]	Model	øD	L <sub>1</sub>	L <sub>2</sub>	P	M	Q	øO	øN	Effective area [mm <sup>2</sup> ]		Min. port size	Weight [g]
										Nylon	Urethane		
ø4	KQ2U04-00A	8.2	29	18.2	8.2	13.3	5.7	6	3.2	4.2	4.2	3	2.9
ø6	KQ2U06-00A	10.4	30.1	19.4	10.4	13.3	6.8	6	3.2	13.4	10.6	4.5	4.1
ø8	KQ2U08-00A	13.2	33.2	22.3	13.2	14.2	8.7	8	4.2	25.6	17.7	6	7.4
ø10	KQ2U10-00A	15.9	37.1	25	15.9	15.6	10.1	8	4.2	40	28.4	7.5	11.2
ø12	KQ2U12-00A	18.5	41.1	27.8	18.5	17	11.4	8	4.2	57.4	45.4	9	16.4
ø16	KQ2U16-00A	23.8	51.5	35	23.8	20.6	14	8	4.2	113	60	13	30.6

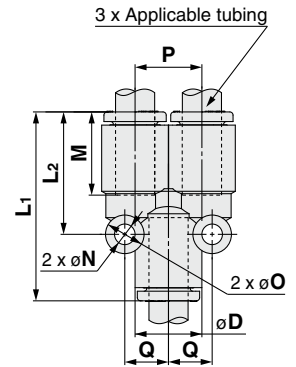

### Different Diameter Union "Y": KQ2U



Applicable tubing O.D. [mm]		Model	øD <sub>1</sub>	øD <sub>2</sub>	L <sub>1</sub>	L <sub>2</sub>	P	M <sub>1</sub>	M <sub>2</sub>	Q	Mounting hole		Effective area [mm <sup>2</sup> ]		Min. port size	Weight [g]	
Ⓐ	Ⓑ										øO	øN	Thickness	Nylon			Urethane
ø4	ø6	KQ2U04-06A	8.2	10.4	29	18	8.2	13.3	13.3	6.8	6	3.2	10.4	4.2	4.2	3	3.3
ø4	ø8	KQ2U04-08A	10.4	13.2	31	19.3	10.4	13.3	14.2	8.2	6	3.2	13.2	4.2	4.2	3	5.2
ø6	ø8	KQ2U06-08A	10.4	13.2	31	19.3	10.4	13.3	14.2	8.2	6	3.2	13.2	13.4	10.6	4.5	5
ø6	ø10	KQ2U06-10A	13.2	15.9	34.6	22.3	13.2	13.3	15.6	10.1	8	4.2	15.9	13.4	10.6	4.5	8.7
ø8	ø10	KQ2U08-10A	13.2	15.9	34.6	22.3	13.2	14.2	15.6	10.1	8	4.2	15.9	25.6	17.7	6	8.6
ø8	ø12	KQ2U08-12A	15.9	18.5	38.5	25	15.9	14.2	17	11.4	8	4.2	18.5	25.6	17.7	6	13.3
ø10	ø12	KQ2U10-12A	15.9	18.5	38.5	25	15.9	15.6	17	11.4	8	4.2	18.5	40	28.4	7.5	12.7
ø12	ø16	KQ2U12-16A	18.5	23.8	47.9	31	18.5	17	20.6	14	8	4.2	23.8	57.4	45.4	9	21.2

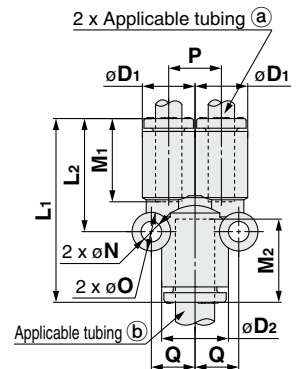

### Different Diameter Double Union "Y": KQ2UD



Applicable tubing O.D. [mm]		Model	øD <sub>1</sub>	øD <sub>2</sub>	L <sub>1</sub>	L <sub>2</sub>	P	I	M <sub>1</sub>	M <sub>2</sub>	Q	øO	øN	Effective area [mm <sup>2</sup> ]		Min. port size	Weight [g]
Ⓐ	Ⓑ													Nylon	Urethane		
ø4	ø6	KQ2UD04-06A	8.2	10.4	29.2	18.2	8.2	16.6	13.3	13.3	6.8	6	3.2	4.2	4.2	3	5.4
ø6	ø8	KQ2UD06-08A	10.4	13.2	32	20.5	10.4	21	13.3	14.2	8.2	6	3.2	13.4	10.6	4.5	8.1

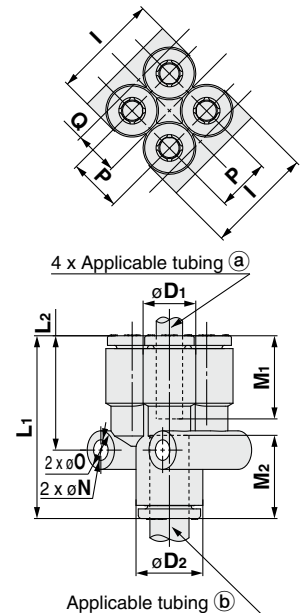

# Metric Size Stainless Steel **KQ2-G Series**

Applicable Tubing: Metric Size, Connection Thread: M, R, Rc

## Dimensions

### Plug-in Reducer: KQ2R

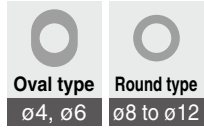

Applicable tubing O.D. [mm]	Applicable fitting size ød	Model	øD	Release button dimensions		L	A	M	Effective area [mm <sup>2</sup> ]		Min. port size	Weight [g]
				øX (X)	Y				Nylon	Urethane		
ø4	ø6	KQ2R04-06A1	8.2	7.7	10	28.6	15.3	13.3	5.6	4	3	1.1
	ø8	KQ2R04-08A1	8.2	7.7	10	29.6	15.4	13.3	5.6	4	3	1.3
	ø10	KQ2R04-10A1	10.4	7.7	10	31.7	16.1	13.3	5.6	4	3	2.2
ø6	ø4	KQ2R06-04A1	10.4	9.7	12	33.6	20.3	13.3	4	4	2.5	1.4
	ø8	KQ2R06-08A1	10.4	9.7	12	31.6	17.4	13.3	13.1	10.4	4.5	1.7
	ø10	KQ2R06-10A1	10.4	9.7	12	33.9	18.3	13.3	13.1	10.4	4.5	2.1
	ø12	KQ2R06-12A1	12	9.7	12	35.7	18.7	13.3	13.1	10.4	4.5	3.2
ø8	ø10	KQ2R08-10A	13.2	13	—	35.1	19.5	14.2	26.1	18	6	2.9
	ø12	KQ2R08-12A	13.2	13	—	36.5	19.5	14.2	26.1	18	6	3.4
ø10	ø12	KQ2R10-12A	15.9	15.6	—	39.2	22.2	15.6	41.5	32.8	7.5	4.5
	ø16	KQ2R10-16A	15.9	15.6	—	44.7	24.1	15.6	41.5	32.8	7.5	6
ø12	ø16	KQ2R12-16A	18.5	18.2	—	45.7	25.1	17	58.3	46.1	9	7

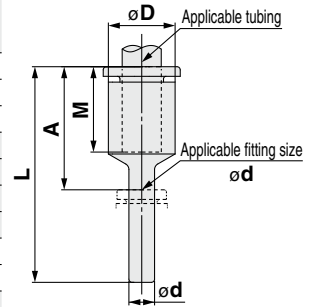

Release button dimensions

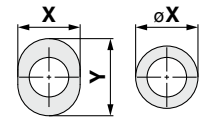

Applicable tubing O.D.: ø4, ø6

### Bulkhead Union: KQ2E-G (Interchangeable with KQ)

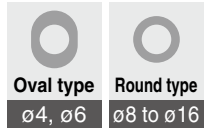

Applicable tubing O.D. [mm]	Model	T (M)	H (Width across flats)	Release button dimensions		L	Mounting hole	M	Effective area [mm <sup>2</sup> ]		Min. port size	Weight [g]
				øX (X)	Y				Nylon	Urethane		
ø4	KQ2E04-00G1	M12 x 1	14	7.7	10	27.3	13	13.3	5.6	4	3	22.9
ø6	KQ2E06-00G1	M14 x 1	17	9.7	12	27.3	15	13.3	13.1	10.4	4.5	28
ø8	KQ2E08-00G	M16 x 1	19	13	—	29.1	17	14.2	26.1	18	6	34
ø10	KQ2E10-00G	M20 x 1	24	15.6	—	31.9	21	15.6	41.5	29.5	7.5	64.4
ø12	KQ2E12-00G	M22 x 1	27	18.2	—	34.7	23	17	58.3	46.1	9	63.8
ø16	KQ2E16-00G	M28 x 1.5	32	23.6	—	41.9	29	20.6	113	67	13	120.1

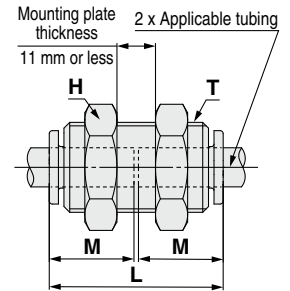

Release button dimensions

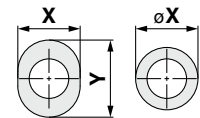

Applicable tubing O.D.: ø4, ø6

### Bulkhead Connector: KQ2E-G

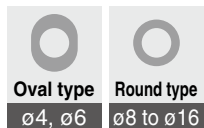

Applicable tubing O.D. [mm]	Connection thread Rc	Model	T (M)	H1 (Width across flats)	H2 (Width across flats)	L1	L2	Release button dimensions		Mounting hole	M	Effective area [mm <sup>2</sup> ]		Min. port size	Weight [g]
								øX (X)	Y			Nylon	Urethane		
ø4	1/8	KQ2E04-01G1	M12 x 1	14	14	24.4	10	7.7	10	13	13.3	5.6	4	3	21.2
	1/4	KQ2E04-02G1	M12 x 1	17	14	29	14.6	7.7	10	13	13.3	5.6	4	3	30.9
ø6	1/8	KQ2E06-01G1	M14 x 1	17	17	23.6	9.2	9.7	12	15	13.3	13.1	10.4	4.5	28.9
	1/4	KQ2E06-02G1	M14 x 1	17	17	28.4	14	9.7	12	15	13.3	13.1	10.4	4.5	32.4
	3/8	KQ2E06-03G1	M14 x 1	19	17	30.7	16.3	9.7	12	15	13.3	13.1	10.4	4.5	35.9
ø8	1/8	KQ2E08-01G	M16 x 1	17	19	24.1	6.7	13	—	17	14.2	26.1	18	6	30.5
	1/4	KQ2E08-02G	M16 x 1	17	19	28.4	11	13	—	17	14.2	26.1	18	6	33.1
	3/8	KQ2E08-03G	M16 x 1	19	19	31.7	14.3	13	—	17	14.2	26.1	18	6	37.4
ø10	1/4	KQ2E10-02G	M20 x 1	22	24	29.3	9.9	15.6	—	21	15.6	41.5	29.5	7.5	63.8
	3/8	KQ2E10-03G	M20 x 1	22	24	31.4	12	15.6	—	21	15.6	41.5	29.5	7.5	71.6
ø12	3/8	KQ2E12-03G	M22 x 1	24	27	32.3	11.9	18.2	—	23	17	58.3	46.1	9	69.3
	1/2	KQ2E12-04G	M22 x 1	24	27	37.7	17.3	18.2	—	23	17	58.3	46.1	9	72.7
ø16	3/8	KQ2E16-03G	M28 x 1.5	30	32	34.4	11.5	23.6	—	29	20.6	96	67	13	122.2
	1/2	KQ2E16-04G	M28 x 1.5	30	32	38.8	15.9	23.6	—	29	20.6	113	67	13	132.1

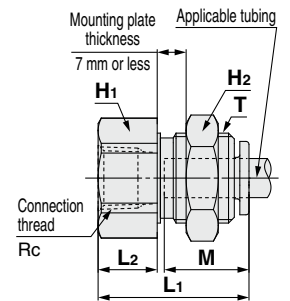

Release button dimensions

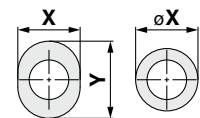

Applicable tubing O.D.: ø4, ø6

# KQ2-G Series

Applicable Tubing: Metric Size, Connection Thread: M, R, Rc

## Dimensions

### Tube Cap: KQ2C

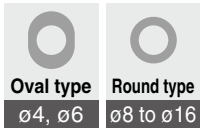

Applicable tubing O.D. [mm]	Model	øD	Release button dimensions		L	M	Weight [g]
			øX(X)	Y			
ø4	<b>KQ2C04-00A1</b>	8.2	7.7	10	14.5	13.3	0.8
ø6	<b>KQ2C06-00A1</b>	10.4	9.7	12	14.6	13.3	1.1
ø8	<b>KQ2C08-00A</b>	13.2	13	—	15.7	14.2	2
ø10	<b>KQ2C10-00A</b>	15.9	15.6	—	17.3	15.6	2.9
ø12	<b>KQ2C12-00A</b>	18.5	18.2	—	18.9	17	4.5
ø16	<b>KQ2C16-00A</b>	23.8	23.6	—	23	20.6	8.4

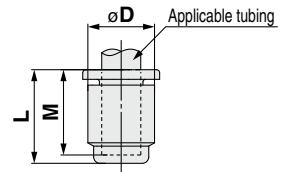

### Release button dimensions

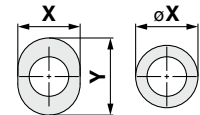

Applicable tubing O.D.: ø4, ø6

## Made to Order / Clean Series / Spare Parts

Please contact SMC for detailed dimensions, specifications and lead times.

### 1 Made to Order

Symbol	Specifications
<b>X12</b>	Lubricant: White vaseline Release button color: White
<b>X17</b>	Grease-free Rubber material: NBR (With fluorine coating) Release button color: Light blue
<b>KQ2□08-01GQ□</b>	Effective area is interchangeable with the current product (KG series). Model: Male elbow, Extended male elbow, Male branch tee, Male run tee Applicable tubing O.D./Port size: ø8/R1/8 Example) <b>KQ2L08-01GQS</b>

### 2 Clean Series

Please consult with SMC separately for applicable models.

Symbol	Specifications
<b>10-</b>	Lubricant: Fluorine grease Air blow in a clean room Double packaging Resin body/Release button color: White

Example) **10-KQ2H06-02GS1** (With thread)  
**10-KQ2H06-00A** (Without thread)

### 3 Spare Parts

Description	Part number	Applicable thread	Applicable model
Gasket	<b>M-5G2</b>	M5	—

Description	Part no.	Applicable model	Material
Pipe nut	<b>KQ04-P01G</b>	KQ2E04-00G1, KQG2E04-01G1, KQ2E04-02G1	Stainless steel 303
	<b>KQ06-P01G</b>	KQ2E06-00G1, KQ2E06-01G1, KQ2E06-02G1, KQ2E06-03G1	
	<b>KQ08-P01G</b>	KQ2E08-00G, KQ2E08-01G, KQ2E08-02G, KQ2E08-03G	
	<b>KQ10-P01G</b>	KQ2E10-00G, KQG2E10-02G, KQ2E10-03G	
	<b>KQ12-P01G</b>	KQ2E12-00G, KQG2E12-03G, KQ2E12-04G	
	<b>KQ16-P01G</b>	KQ2E16-00G, KQG2E16-03G, KQ2E16-04G	



# Metric Size One-touch Fittings Stainless Steel Series

Applicable Tubing: Metric Size, Connection Thread: G

## KQ2-G Series

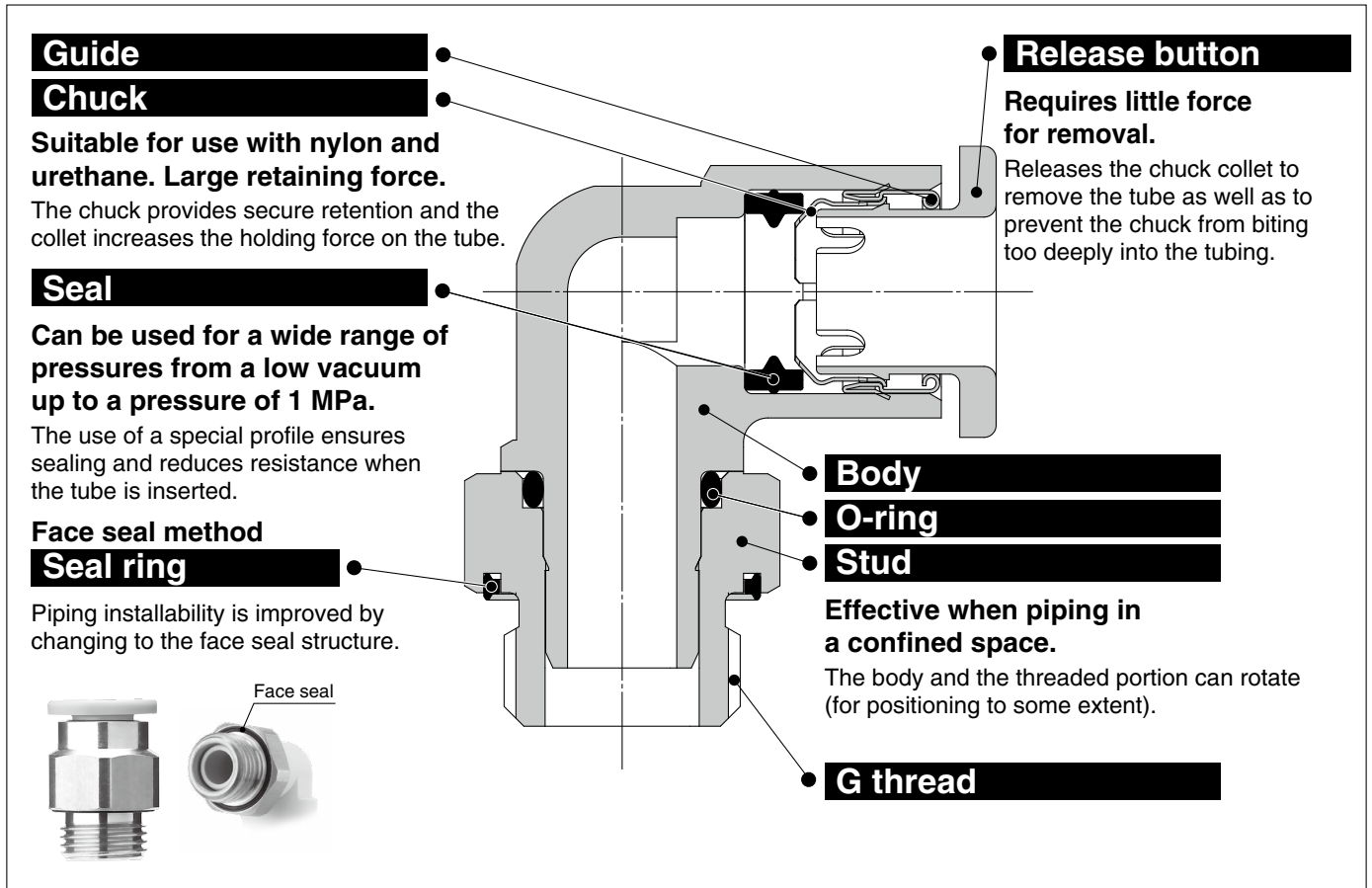

Stainless specifications for use in corrosive environments  
Stainless steel 303 is used for metal material.

Applicable to parallel pipe thread (G).

Drastically reduces screw-in time with the face seal method.



### Applicable Tubing

Tubing material	FEP, PFA, Nylon, Soft nylon, Polyurethane
Tubing O.D.	ø4, ø6, ø8, ø10, ø12, ø16

### Specifications

Fluid	Air, Water*1 *2	
Operating pressure range*3	-100 kPa to 1 MPa	
Proof pressure (at 23°C)	3 MPa	
Ambient and fluid temperature	-5 to 60°C, Water: 0 to 40°C (No freezing)	
Thread	Mounting section	ISO 16030 (Parallel pipe thread)
Seal on the threads	Seal ring	

\*1 The surge pressure must be under the maximum operating pressure.

\*2 Deionized water is not recommended for use as it may affect the material used in the fittings. In addition, it is known to degrade the water quality.

\*3 Do not use the fittings with a leak tester or for vacuum retention because they are not guaranteed for zero leakage.

### Principal Parts Material

Body	Stainless steel 303, PBT
Stud	Stainless steel 303 (Thread portion)
Chuck	Stainless steel 304
Guide	Stainless steel 304
Release button	POM
Seal, O-ring, Seal ring	NBR

# KQ2-G Series

Applicable Tubing: Metric Size, Connection Thread: G

## How to Order

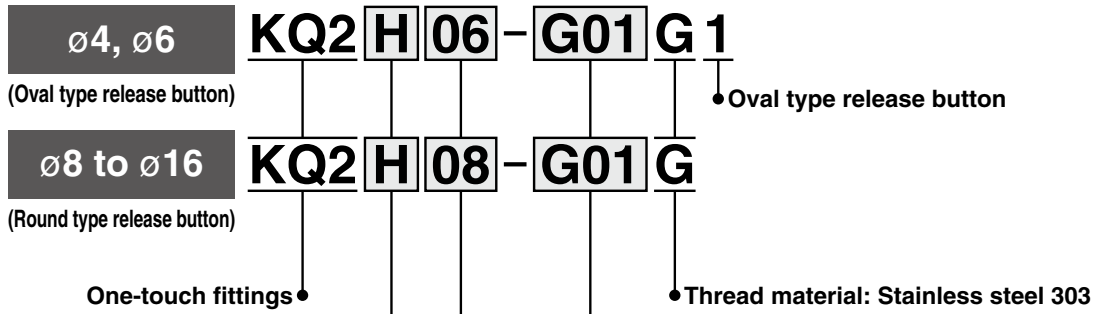

Model

Symbol	Model	Oval type	Round type
<b>H</b>	Male connector	○	○
<b>S</b>	Hexagon socket head male connector	○	○
<b>L</b>	Male elbow	○	○
<b>LU</b>	Branch male elbow	—	○
<b>T</b>	Male branch tee	○	○
<b>Y</b>	Male run tee	○	○
<b>D</b>	Male delta union	○	○
<b>U</b>	Branch "Y"	—	○
<b>UD</b>	Double branch "Y"	—	○

Port size

	Symbol	Size
Thread connection	<b>G01</b>	G1/8
	<b>G02</b>	G1/4
	<b>G03</b>	G3/8
	<b>G04</b>	G1/2

Applicable tubing O.D.

Symbol	Size
<b>04</b>	ø4
<b>06</b>	ø6
<b>08</b>	ø8
<b>10</b>	ø10
<b>12</b>	ø12
<b>16</b>	ø16

# Metric Size One-touch Fittings

## Variations

### Male connector

KQ2H

p. 19-4



Use to pipe a female thread in the same direction.  
Most general model.

### Hexagon socket head male connector

KQ2S

p. 19-4



Internal hexagon socket allows tightening with a hexagon wrench in confined spaces.



### Male elbow

KQ2L

p. 19-4



Use to pipe a female thread at right angles.  
Most general model.

### Male branch tee

KQ2T

p. 19-5



Use to branch a female thread at both 90° angles.

### Male run tee

KQ2Y

p. 19-5



Use to branch a female thread in the same direction and at a 90° angle.

### Male delta union

KQ2D

p. 19-5



Use to branch a female thread at two right angles.

### Branch male elbow

KQ2LU

p. 19-6



Use to two-branch a female thread at right angles.

### Branch "Y"

KQ2U

p. 19-6



Use to branch a female thread in the same direction.

### Double branch "Y"

KQ2UD

p. 19-6



Use to four-branch a female thread in the same direction.

# KQ2-G Series

Applicable Tubing: Metric Size, Connection Thread: G

## Dimensions

### Male Connector: KQ2H (Face seal)

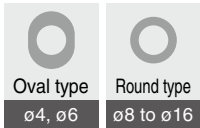

Applicable tubing O.D. [mm]	Connection thread G	Model	H (Width across flats)	øD	Release button dimensions		L	A	M	Effective area [mm <sup>2</sup> ]		Min. port size	Weight [g]
					øX (X)	Y				Nylon	Urethane		
ø4	1/8	KQ2H04-G01G1	12	7.9	7.7	10	17.1	11.6	13.3	4.8	3.4	3	7.7
	1/4	KQ2H04-G02G1	17	—	7.7	10	15.4	8.9	13.3	4.8	3.4	3	16.8
ø6	1/8	KQ2H06-G01G1	12	9.9	9.7	12	17.3	11.8	13.3	13.1	10.4	4.5	6.6
	1/4	KQ2H06-G02G1	17	—	9.7	12	15.4	8.9	13.3	13.1	10.4	4.5	14.8
ø6	3/8	KQ2H06-G03G1	21	—	9.7	12	16.4	8.9	13.3	13.1	10.4	4.5	27.1
	1/8	KQ2H08-G01G	14	12.4	13	—	21.4	15.9	14.2	26.1	18	6	7.5
ø8	1/4	KQ2H08-G02G	17	12.4	13	—	19.9	13.4	14.2	26.1	18	6	15.5
	3/8	KQ2H08-G03G	21	—	13	—	16.4	8.9	14.2	26.1	18	6	23.8
ø10	1/8	KQ2H10-G01G	17	14.8	15.6	—	23.2	17.7	15.6	26.1	26.1	6	15.7
	1/4	KQ2H10-G02G	17	14.8	15.6	—	22.8	16.3	15.6	41.5	29.5	7.5	16.8
ø10	3/8	KQ2H10-G03G	21	14.8	15.6	—	21.8	14.3	15.6	41.5	29.5	7.5	26.1
	1/2	KQ2H10-G04G	27	—	15.6	—	17.9	8.9	15.6	41.5	29.5	7.5	39.9
ø12	1/4	KQ2H12-G02G	19	17.2	18.2	—	25.3	18.8	17	58.3	46.1	9	15.1
	3/8	KQ2H12-G03G	21	17.2	18.2	—	23.6	16.1	17	58.3	46.1	9	25.6
ø12	1/2	KQ2H12-G04G	27	17.2	18.2	—	24.8	15.8	17	58.3	46.1	9	46.9
	3/8	KQ2H16-G03G	27	22	23.6	—	30.5	23	20.6	81	67	11	47.1
ø16	1/2	KQ2H16-G04G	27	22	23.6	—	29.7	20.7	20.6	113	67	13	48.8

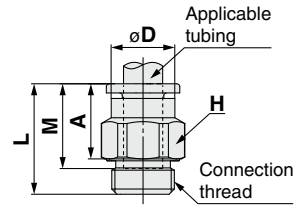

Release button dimensions

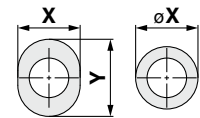

Applicable tubing O.D.: ø4, ø6

### Hexagon Socket Head Male Connector: KQ2S (Face seal)

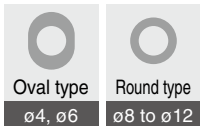

Applicable tubing O.D. [mm]	Connection thread G	Model	H (Width across flats)	øD	Release button dimensions		L <sub>1</sub>	L <sub>2</sub>	A	M	Effective area [mm <sup>2</sup> ]		Min. port size	Weight [g]
					øX (X)	Y					Nylon	Urethane		
ø4	1/8	KQ2S04-G01G1	3	13	7.7	10	20.6	19.6	15.1	13.3	4.1	3.6	3.1	11.6
	1/4	KQ2S06-G01G1	4	13	9.7	12	19.8	18.8	14.3	13.3	10	9.9	4.1	9.7
ø6	1/4	KQ2S06-G02G1	4	18	9.7	12	19.8	18.8	13.3	13.3	10.7	10	4.1	18
	1/8	KQ2S08-G01G	5	13	13	—	21.7	19.7	16.2	14.2	17.2	16.2	5.1	9.5
ø8	1/4	KQ2S08-G02G	6	18	13	—	20.5	19.5	14	14.2	23.3	16.2	6.1	17.2
	3/8	KQ2S08-G03G	6	22	13	—	20.7	19.7	13.2	14.2	23.3	16.2	6.1	27.1
ø10	1/8	KQ2S10-G01G	5	15	15.6	—	23	21.1	17.5	15.6	17.2	16.2	5.1	10.9
	1/4	KQ2S10-G02G	8	18	15.6	—	24.1	20.1	17.6	15.6	39	26.6	8.1	19.2
ø10	3/8	KQ2S10-G03G	8	22	15.6	—	21.4	20.1	13.9	15.6	39	26.6	8.1	25
	1/2	KQ2S10-G04G	8	26	15.6	—	21.1	20.1	12.1	15.6	39	26.6	8.1	34.1
ø12	1/4	KQ2S12-G02G	8	18	18.2	—	25.6	21.5	19.1	17	46	44.5	8.1	18.3
	3/8	KQ2S12-G03G	10	22	18.2	—	23.8	21.8	16.3	17	60	44.5	10.1	25.7
ø12	1/2	KQ2S12-G04G	10	26	18.2	—	22.8	21.8	13.8	17	60	44.5	10.1	35.6

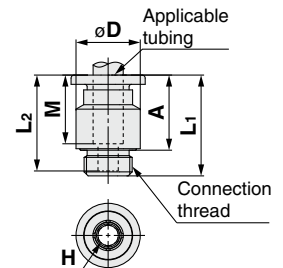

Release button dimensions

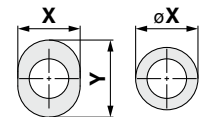

Applicable tubing O.D.: ø4, ø6

### Male Elbow: KQ2L (Face seal)

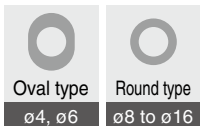

Applicable tubing O.D. [mm]	Connection thread G	Model	H (Width across flats)	øD <sub>1</sub>	øD <sub>2</sub>	Release button dimensions		L <sub>1</sub>	L <sub>2</sub>	A	M	Effective area [mm <sup>2</sup> ]		Min. port size	Weight [g]	With a rib
						øX (X)	Y					Nylon	Urethane			
ø4	1/8	KQ2L04-G01G1	12	8.2	10	7.7	10	14.8	16.8	15.4	13.3	4.6	3.3	3	6.3	●
	1/4	KQ2L04-G02G1	17	8.2	10	7.7	10	14.8	20.3	17.9	13.3	4.6	3.3	3	16.7	●
ø6	1/8	KQ2L06-G01G1	12	10.4	10	9.7	12	15.5	17.9	17.6	13.3	11.4	9	4.5	6.7	—
	1/4	KQ2L06-G02G1	17	10.4	10	9.7	12	15.5	21.4	20.1	13.3	11.4	9	4.5	17.2	—
ø6	3/8	KQ2L06-G03G1	21	10.4	10	9.7	12	15.5	22.4	20.1	13.3	11.4	9	4.5	28.9	—
	1/8	KQ2L08-G01G	12	13.2	10	13	—	16.4	19.3	20.4	14.2	11.4	11.4	4.5	7.6	●
ø8	1/4	KQ2L08-G02G	17	13.2	12	13	—	17.2	22.8	22.9	14.2	21.6	14.9	6	15.9	●
	3/8	KQ2L08-G03G	21	13.2	12	13	—	17.2	23.8	22.9	14.2	21.6	14.9	6	27.9	●
ø10	1/8	KQ2L10-G01G	12	15.9	12	15.6	—	18.6	22.5	24.9	15.6	21.6	14.9	6	10.3	●
	1/4	KQ2L10-G02G	17	15.9	17	15.6	—	19.3	24.6	26	15.6	35.2	25	7.5	17.5	●
ø10	3/8	KQ2L10-G03G	21	15.9	17	15.6	—	19.3	27.7	28.1	15.6	35.2	25	7.5	22.6	●
	1/2	KQ2L10-G04G	27	15.9	17	15.6	—	19.3	29.2	28.1	15.6	35.2	25	7.5	42.5	●
ø12	1/4	KQ2L12-G02G	17	18.5	17	18.2	—	21.5	25.9	28.6	17	50.2	39.7	9	19.3	●
	3/8	KQ2L12-G03G	21	18.5	17	18.2	—	21.5	29	30.7	17	50.2	39.7	9	24.5	●
ø12	1/2	KQ2L12-G04G	27	18.5	17	18.2	—	21.5	30.5	30.7	17	50.2	39.7	9	44.4	●
	3/8	KQ2L16-G03G	21	23.8	21	23.6	—	27.1	33.1	37.5	20.6	71	58.9	11	35.2	—
ø16	1/2	KQ2L16-G04G	27	23.8	21	23.6	—	27.1	33.8	36.7	20.6	100	58.9	13	58.7	—

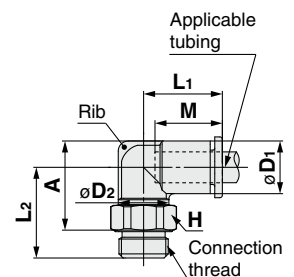

Release button dimensions

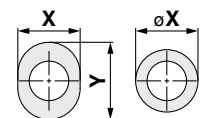

Applicable tubing O.D.: ø4, ø6

# Metric Size One-touch Fittings Stainless Steel Series **KQ2-G Series**

Applicable Tubing: Metric Size, Connection Thread: G

## Dimensions

### Male Branch Tee: KQ2T (Face seal)

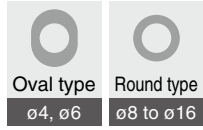

Applicable tubing O.D. [mm]	Connection thread G	Model	H (Width across flats)	øD1	øD2	Release button dimensions		L1	L2	A	M	Effective area [mm <sup>2</sup> ]		Min. port size	Weight [g]
						øX (X)	Y					Nylon	Urethane		
ø4	1/8	KQ2T04-G01G1	12	8.2	10	7.7	10	14.8	16.8	15.4	13.3	6	4.1	3	7
	1/4	KQ2T04-G02G1	17	8.2	10	7.7	10	14.8	20.3	17.9	13.3	6	4.1	3	17.4
ø6	1/8	KQ2T06-G01G1	12	10.4	10	9.7	12	15.5	17.9	17.6	13.3	13.9	11	4.5	7.6
	1/4	KQ2T06-G02G1	17	10.4	10	9.7	12	15.5	21.4	20.1	13.3	13.9	11	4.5	18.1
	3/8	KQ2T06-G03G1	21	10.4	10	9.7	12	15.5	22.4	20.1	13.3	13.9	11	4.5	29.8
ø8	1/8	KQ2T08-G01G	12	13.2	10	13	—	16.4	19.3	20.4	14.2	14	14	4.5	9.4
	1/4	KQ2T08-G02G	17	13.2	12	13	—	17.2	22.8	22.9	14.2	26.3	18.2	6	17.6
	3/8	KQ2T08-G03G	21	13.2	12	13	—	17.2	23.8	22.9	14.2	26.3	18.2	6	29.6
ø10	1/8	KQ2T10-G01G	12	15.9	12	15.6	—	18.6	22.4	24.9	15.6	21.6	14.9	6	13.1
	1/4	KQ2T10-G02G	17	15.9	17	15.6	—	19.3	24.5	26	15.6	35.2	25	7.5	20.1
	3/8	KQ2T10-G03G	21	15.9	17	15.6	—	19.3	27.6	28.1	15.6	35.2	25	7.5	25.3
	1/2	KQ2T10-G04G	27	15.9	17	15.6	—	19.3	29.1	28.1	15.6	35.2	25	7.5	45.2
ø12	1/4	KQ2T12-G02G	17	18.5	17	18.2	—	21.5	25.8	28.6	17	57.2	45.2	9	23.1
	3/8	KQ2T12-G03G	21	18.5	17	18.2	—	21.5	28.9	30.7	17	57.2	45.2	9	28.4
	1/2	KQ2T12-G04G	27	18.5	17	18.2	—	21.5	30.4	30.7	17	57.2	45.2	9	48.3
ø16	3/8	KQ2T16-G03G	21	23.8	21	23.6	—	27.1	33.1	37.5	20.6	71	58.9	11	42.1
	1/2	KQ2T16-G04G	27	23.8	21	23.6	—	27.1	33.8	36.7	20.6	100	58.9	13	65.7

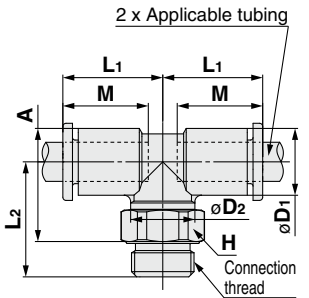

Release button dimensions

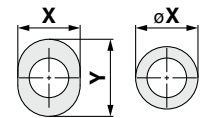

Applicable tubing O.D.: ø4, ø6

### Male Run Tee: KQ2Y (Face seal)

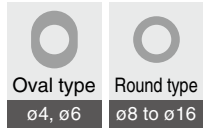

Applicable tubing O.D. [mm]	Connection thread G	Model	H (Width across flats)	øD	øD2	Release button dimensions		L1	L2	L3	A	M	Effective area [mm <sup>2</sup> ]		Min. port size	Weight [g]
						øX (X)	Y						Nylon	Urethane		
ø4	1/8	KQ2Y04-G01G1	12	8.2	10	7.7	10	15.3	16.8	15.3	26.6	13.3	6.4	4.4	3	7
	1/4	KQ2Y04-G02G1	17	8.2	10	7.7	10	15.3	20.3	15.3	29.1	13.3	6.4	4.4	3	17.5
ø6	1/8	KQ2Y06-G01G1	12	10.4	10	9.7	12	16.3	17.9	16.3	28.7	13.3	13.4	10.6	4.5	7.7
	1/4	KQ2Y06-G02G1	17	10.4	10	9.7	12	16.3	21.4	16.3	31.2	13.3	13.4	10.6	4.5	18.2
	3/8	KQ2Y06-G03G1	21	10.4	10	9.7	12	16.3	22.4	16.3	31.2	13.3	13.4	10.6	4.5	29.9
ø8	1/8	KQ2Y08-G01G	12	13.2	10	13	—	18.2	19.3	18.2	32	14.2	13.4	13.4	4.5	9.5
	1/4	KQ2Y08-G02G	17	13.2	12	13	—	18.2	22.8	18.2	34.5	14.2	25.6	17.7	6	17.7
	3/8	KQ2Y08-G03G	21	13.2	12	13	—	18.2	23.8	18.2	34.5	14.2	25.6	17.7	6	29.7
ø10	1/8	KQ2Y10-G01G	12	15.9	12	15.6	—	20.6	22.5	20.6	37.5	15.6	40	28.4	6	13.2
	1/4	KQ2Y10-G02G	17	15.9	17	15.6	—	20.6	24.6	20.6	38.6	15.6	40	28.4	7.5	20.3
	3/8	KQ2Y10-G03G	21	15.9	17	15.6	—	20.6	27.7	20.6	40.7	15.6	40	28.4	7.5	25.4
	1/2	KQ2Y10-G04G	27	15.9	17	15.6	—	20.6	29.2	20.6	40.7	15.6	40	28.4	7.5	45.3
ø12	1/4	KQ2Y12-G02G	17	18.5	17	18.2	—	23	25.9	23	42.3	17	57.4	45.4	9	23.4
	3/8	KQ2Y12-G03G	21	18.5	17	18.2	—	23	29	23	44.4	17	57.4	45.4	9	28.6
	1/2	KQ2Y12-G04G	27	18.5	17	18.2	—	23	30.4	23	44.4	17	57.4	45.4	9	48.5
ø16	3/8	KQ2Y16-G03G	21	23.8	21	23.6	—	28.6	33.1	28.6	54.2	20.6	81	60	11	42.7
	1/2	KQ2Y16-G04G	27	23.8	21	23.6	—	28.6	33.8	28.6	53.4	20.6	113	60	13	66.2

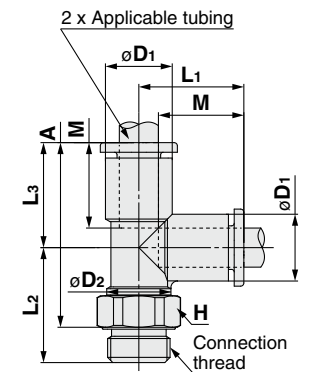

Release button dimensions

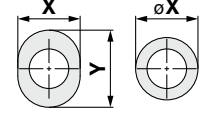

Applicable tubing O.D.: ø4, ø6

### Male Delta Union: KQ2D (Face seal)

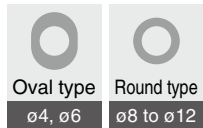

Applicable tubing O.D. [mm]	Connection thread G	Model	H (Width across flats)	øD	Release button dimensions		L1	L2	A	M	Q	Mounting hole			Effective area [mm <sup>2</sup> ]		Min. port size	Weight [g]
					øX (X)	Y						øO	øN	Thickness	Nylon	Urethane		
ø4	1/8	KQ2D04-G01G1	12	8.2	7.7	10	15.8	23.9	22.6	13.3	5.7	6	3.2	8.2	6	6	3.6	10.3
	1/4	KQ2D04-G02G1	17	8.2	7.7	10	15.8	26.9	24.6	13.3	5.7	6	3.2	8.2	6	6	3.6	22
ø6	1/8	KQ2D06-G01G1	12	10.4	9.7	12	16.8	24.9	24.7	13.3	6.7	6	3.2	10.4	13.9	11	5.4	10.8
	1/4	KQ2D06-G02G1	17	10.4	9.7	12	16.8	27.9	26.7	13.3	6.7	6	3.2	10.4	13.9	11	5.4	22.2
	3/8	KQ2D06-G03G1	21	10.4	9.7	12	16.8	28.4	26.2	13.3	6.7	6	3.2	10.4	13.9	11	5.4	33.5
ø8	1/8	KQ2D08-G01G	14	13.2	13	—	18.8	26.9	28.1	14.2	8.4	8	4.2	13.2	26.3	18.2	6	16.4
	1/4	KQ2D08-G02G	17	13.2	13	—	18.8	29.9	30.1	14.2	8.4	8	4.2	13.2	26.3	18.2	7.3	23.7
	3/8	KQ2D08-G03G	21	13.2	13	—	18.8	30.4	29.6	14.2	8.4	8	4.2	13.2	26.3	18.2	7.3	34.9
ø10	1/4	KQ2D10-G02G	17	15.9	15.6	—	21.2	32.3	33.8	15.6	9.6	8	4.2	15.9	40.8	29	9	25.8
	3/8	KQ2D10-G03G	21	15.9	15.6	—	21.2	32.8	33.3	15.6	9.6	8	4.2	15.9	40.8	29	9.4	38
ø12	1/2	KQ2D10-G04G	27	15.9	15.6	—	21.2	34.3	33.3	15.6	9.6	8	4.2	15.9	40.8	29	9.4	56.9
	1/4	KQ2D12-G02G	19	18.5	18.2	—	23.6	34.7	37.5	17	10.7	8	4.2	18.5	57.2	45.2	9	37
	3/8	KQ2D12-G03G	21	18.5	18.2	—	23.6	35.2	37	17	10.7	8	4.2	18.5	57.2	45.2	11	39
ø12	1/2	KQ2D12-G04G	27	18.5	18.2	—	23.6	36.7	37	17	10.7	8	4.2	18.5	57.2	45.2	11.6	57.6

Release button dimensions

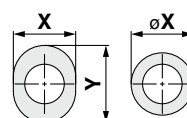

Applicable tubing O.D.: ø4, ø6

# KQ2-G Series

Applicable Tubing: Metric Size, Connection Thread: G

## Dimensions

### Branch Male Elbow: KQ2LU (Face seal)



Applicable tubing O.D. (mm)	Connection thread G	Model	H (Width across flats)	øD	Release button dimensions øX (X)	L1	L2	L3	A	M	P	Mounting hole			Effective area (mm <sup>2</sup> )		Min. port size	Weight [g]		
												øO	øN	Thickness	Nylon	Urethane				
ø4	1/8	KQ2LU04-G01G	12	8.2	7.7	15.8	23.9	28.1	22.6	13.3	8.2	6	3.2	8.2	15.8	7.9	6	4.1	3	10.7
	1/4	KQ2LU04-G02G	17	8.2	7.7	15.8	26.9	31.1	24.6	13.3	8.2	6	3.2	8.2	15.8	7.9	6	4.1	3	22.4
ø6	1/8	KQ2LU06-G01G	12	10.4	9.7	16.5	24.6	29.9	24.4	13.3	10.4	6	3.2	10.4	16.5	10	13.9	11	4.5	11.3
	1/4	KQ2LU06-G02G	17	10.4	9.7	16.5	27.6	32.9	26.4	13.3	10.4	6	3.2	10.4	16.5	10	13.9	11	4.5	22.7
ø6	3/8	KQ2LU06-G03G	21	10.4	9.7	16.5	28.1	33.4	25.9	13.3	10.4	6	3.2	10.4	16.5	10	13.9	11	4.5	34
	1/8	KQ2LU08-G01G	14	13.2	13	18.2	26.3	33	27.5	14.2	13.2	8	4.2	13.2	18.2	13.1	26.3	18.2	6	17.6
ø8	1/4	KQ2LU08-G02G	17	13.2	13	18.2	29.3	36	29.5	14.2	13.2	8	4.2	13.2	18.2	13.1	26.3	18.2	6	24.8
	3/8	KQ2LU08-G03G	21	13.2	13	18.2	29.8	36.5	29	14.2	13.2	8	4.2	13.2	18.2	13.1	26.3	18.2	6	36
ø10	1/4	KQ2LU10-G02G	17	15.9	15.6	20.3	31.4	39.5	33	15.6	15.9	8	4.2	15.9	20.3	15.9	40.8	29	7.5	27.5
	3/8	KQ2LU10-G03G	21	15.9	15.6	20.3	31.9	40	32.5	15.6	15.9	8	4.2	15.9	20.3	15.9	40.8	29	7.5	39.7
ø10	1/2	KQ2LU10-G04G	27	15.9	15.6	20.3	33.4	41.5	32.5	15.6	15.9	8	4.2	15.9	20.3	15.9	40.8	29	7.5	58.6
	1/4	KQ2LU12-G02G	19	18.5	18.2	22.5	33.6	42.9	36.4	17	18.5	8	4.2	18.5	22.5	17.9	57.2	45.2	9	39.7
ø12	3/8	KQ2LU12-G03G	21	18.5	18.2	22.5	34.1	43.4	35.9	17	18.5	8	4.2	18.5	22.5	17.9	57.2	45.2	9	41.7
	1/2	KQ2LU12-G04G	27	18.5	18.2	22.5	35.6	44.9	35.9	17	18.5	8	4.2	18.5	22.5	17.9	57.2	45.2	9	60.3

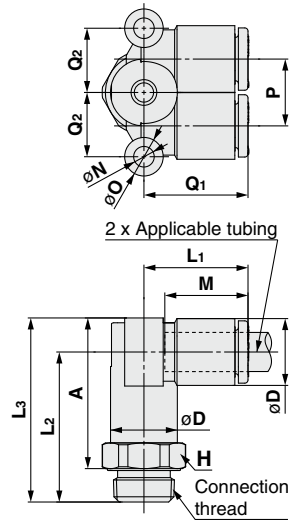

### Branch "Y": KQ2U (Face seal)

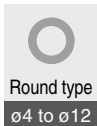

Applicable tubing O.D. (mm)	Connection thread G	Model	H (Width across flats)	øD	Release button dimensions øX (X)	L	A	M	P	Q	Mounting hole			Effective area (mm <sup>2</sup> )		Min. port size	Weight [g]
											øO	øN	Thickness	Nylon	Urethane		
ø4	1/8	KQ2U04-G01G	12	8.2	7.7	37.1	31.6	13.3	8.2	5.7	6	3.2	8.2	4.2	4.2	3.6	10.5
	1/4	KQ2U04-G02G	17	8.2	7.7	40.1	33.6	13.3	8.2	5.7	6	3.2	8.2	4.2	4.2	3.6	22.2
ø6	1/8	KQ2U06-G01G	12	10.4	9.7	38.2	32.7	13.3	10.4	6.8	6	3.2	10.4	13.4	10.6	5.4	11
	1/4	KQ2U06-G02G	17	10.4	9.7	41.2	34.7	13.3	10.4	6.8	6	3.2	10.4	13.4	10.6	5.4	22.4
ø6	3/8	KQ2U06-G03G	21	10.4	9.7	41.7	34.2	13.3	10.4	6.8	6	3.2	10.4	13.4	10.6	5.4	33.7
	1/8	KQ2U08-G01G	14	13.2	13	41.3	35.8	14.2	13.2	8.7	8	4.2	13.2	25.6	17.7	6	17
ø8	1/4	KQ2U08-G02G	17	13.2	13	44.3	37.8	14.2	13.2	8.7	8	4.2	13.2	25.6	17.7	7.3	24.2
	3/8	KQ2U08-G03G	21	13.2	13	44.8	37.3	14.2	13.2	8.7	8	4.2	13.2	25.6	17.7	7.3	35.4
ø10	1/4	KQ2U10-G02G	17	15.9	15.6	48.2	41.7	15.6	15.9	10.1	8	4.2	15.9	40	28.4	9	26.5
	3/8	KQ2U10-G03G	21	15.9	15.6	48.7	41.2	15.6	15.9	10.1	8	4.2	15.9	40	28.4	9.4	38.7
ø10	1/2	KQ2U10-G04G	27	15.9	15.6	50.2	41.2	15.6	15.9	10.1	8	4.2	15.9	40	28.4	9.4	57.6
	1/4	KQ2U12-G02G	19	18.5	18.2	52.2	45.7	17	18.5	11.4	8	4.2	18.5	57.4	45.4	9	38
ø12	3/8	KQ2U12-G03G	21	18.5	18.2	52.7	45.2	17	18.5	11.4	8	4.2	18.5	57.4	45.4	11	39.9
	1/2	KQ2U12-G04G	27	18.5	18.2	54.2	45.2	17	18.5	11.4	8	4.2	18.5	57.4	45.4	11.6	58.6

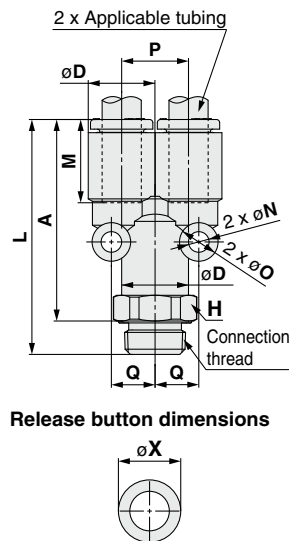

### Double Branch "Y": KQ2UD (Face seal)

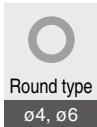

Applicable tubing O.D. (mm)	Connection thread G	Model	H (Width across flats)	øD1	øD2	Release button dimensions øX (X)	L	I	A	M	P	Q	Mounting hole			Effective area (mm <sup>2</sup> )		Min. port size	Weight [g]
													øO	øN	Thickness	Nylon	Urethane		
ø4	1/8	KQ2UD04-G01G	12	8.2	10.4	7.7	37.3	16.6	31.8	13.3	8.2	6.8	6	3.2	4.2	4.2	5.4	12.4	
	1/4	KQ2UD04-G02G	17	8.2	10.4	7.7	40.3	16.6	33.8	13.3	8.2	6.8	6	3.2	4.2	4.2	5.4	23.7	
ø6	1/8	KQ2UD06-G01G	14	10.4	13.2	9.7	40.1	21	34.6	13.3	10.4	8.2	6	3.2	13.4	10.6	6	17.6	
	1/4	KQ2UD06-G02G	17	10.4	13.2	9.7	43.1	21	36.6	13.3	10.4	8.2	6	3.2	13.4	10.6	7.3	24.9	

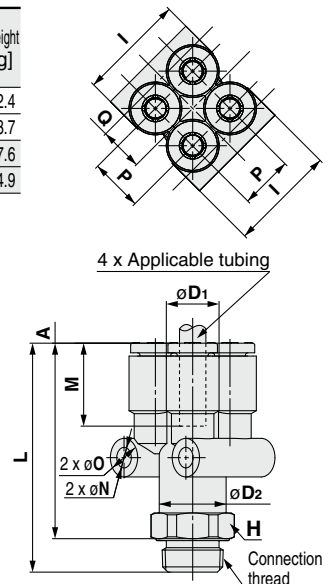
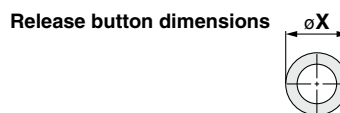



# For Pneumatic Piping/Fittings & Tubing Prior to Use

## Fittings with Sealant

Seal material (fluororesin) is coated on the thread part with the proper thickness and range, that reduces the piping work, such as coating the seal on the thread.

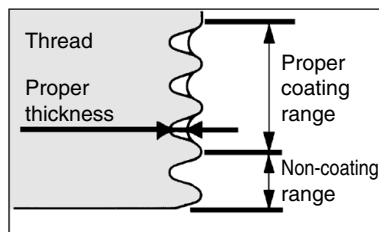
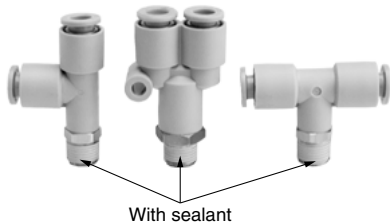

## Female Thread Conditions Applicable to Face Seal

1. Surface roughness of bearing surface: Rz 25 or less
  2. Chamfer dimension:  $\phi D1$ , Seal bearing surface diameter:  $\phi D2$  (Refer to the table below.)
  3. Female thread inclination angle:  $1^\circ$  or less
  4. Counterbore diameter when the female thread is counterbored.:  $\phi D3$ 
    - Models with width across flats: Body width across flats x 1.1 or more
    - Models other than hexagon (Hexagon socket head male connector etc.): Body dimensions + 0.2 mm or more
- \*: The width across flats and the body dimensions differ depending on the model even when the same thread size is used. Refer to the dimensions in the catalog.
5. If oil content or sealant is sticking to the female thread, this may cause damage of the product. Remove it before piping.

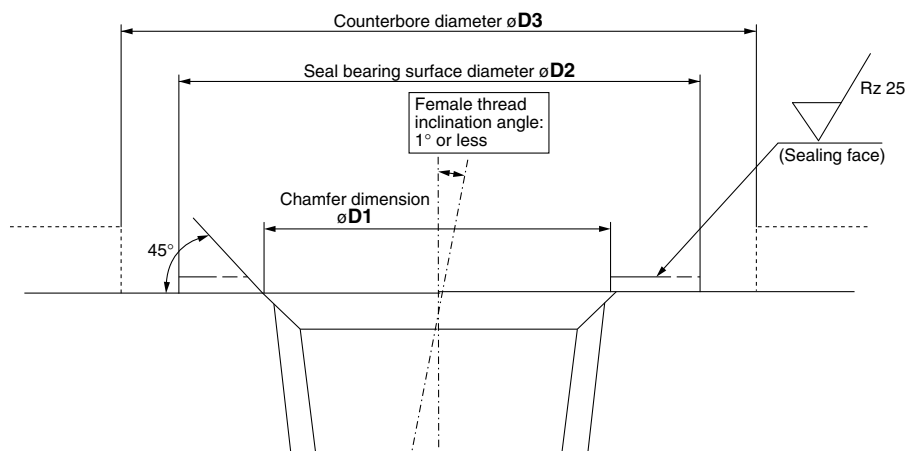

**Table 1**

Connection thread size	Chamfer dimension $\phi D1$ [mm]	Seal bearing surface diameter $\phi D2$ [mm]
R1/8	10.2 to 10.4	12 or more
R1/4	13.6 to 13.8	17 or more
R3/8	17.1 to 17.3	21 or more
R1/2	21.4 to 21.6	27 or more
NPT1/16	8.2 to 8.4	11.11 or more
NPT1/8	10.5 to 10.7	12.7 or more
NPT1/4	14.1 to 14.3	17.46 or more
NPT3/8	17.4 to 17.6	22 or more
NPT1/2	21.7 to 21.9	28.7 or more
G1/8	10.2 to 10.6	12 or more
G1/4	13.6 to 14.0	17 or more
G3/8	17.1 to 17.5	21 or more
G1/2	21.4 to 21.8	27 or more

### ⚠ Precautions

For products that do not satisfy the female thread conditions shown above and the piping with a piping pitch narrower than the product dimension, use the current sealant type.

\*: The rubber parts of the face seal cannot be replaced.

\*: The rubber parts of the face seal may fall off by the air blow and they cannot be mounted again. Be careful not to perform the air blow.



# Fittings & Tubing Precautions 1

Be sure to read this before handling products.

## Design / Selection

### Warning

#### 1. Confirm the specifications.

Products represented in this catalog are designed only for use in compressed air systems (including vacuum).

Do not operate at pressures, temperatures, etc., beyond the range of specifications, as this can cause damage or malfunction. (Refer to the specifications.)

Please contact SMC when using a fluid other than compressed air (including vacuum).

We do not guarantee against any damage if the product is used outside of the specification range.

#### 2. Do not disassemble the product or make any modifications, including additional machining.

It may cause human injury and/or an accident.

#### 3. Check if PTFE can be used in application.

PTFE powder (Polytetrafluoroethylene resin) is included in the sealant. Confirm that the use of it will not cause any adverse effect on the system.

### Caution

#### 1. Keep the connection part of fittings and tubing from rotating or oscillating movement. Use Rotary One-touch Fittings (KS or KX series) in these cases.

The fittings may be damaged if they are used in the above manner.

#### 2. The tubing bending radius in the vicinity of the fitting should be at least the minimum bending radius of the tubing.

If the bending radius is less than the minimum value, fittings may damage, or tubing may crack or be crushed. The minimum bending radius, with the exception of TS soft nylon tubing, TU polyurethane tubing, TUH hard polyurethane tubing, TUS soft polyurethane tubing, TRBU FR double layer polyurethane tubing, TH FEP tubing, TL PFA tubing, TD modified PTFE tubing, is measured as following in accordance with JIS B 8381-1995.

Tubing deformation ratio at the minimum bending radius is obtained through the following formula, based on tubing diameter and mandrel diameter by winding the same radius mandrel tube.

$$\eta = \left(1 - \frac{L - D}{2d}\right) \times 100$$

Here,  $\eta$  : Deformation ratio [%]  
 $d$  : Tubing diameter [mm]  
 $L$  : Measured length [mm]  
 $D$  : Mandrel diameter [mm]  
(Twice against the minimum bending radius)

Test temperature: 20 ±5°C  
Relative humidity: 65 ±5%

Tube deformation ratio at the minimum bending radius

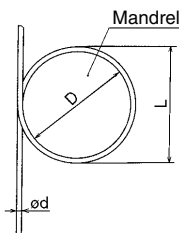

#### 3. Do not use fluids other than listed on the specifications.

Applicable fluids are air and water. Please consult with SMC if using other fluids.

#### 4. When it is used with water, the fittings or tubing may be damaged depending on the surge pressure.

## Mounting / Piping

### Warning

#### 1. Operation manual

Install the products and operate them only after reading the operation manual carefully and understanding its contents. Also, keep the manual where it can be referred to as necessary.

#### 2. Maintenance space

Allow sufficient space for maintenance and inspection.

#### 3. Adhere to the thread tightening method.

Refer to "Connection Thread Tightening Method" when mounting the product.

#### 4. There may be cases of the tubing detaching from the fitting and thrashing around uncontrollably due to tubing degradation or fitting breakage.

To prevent the situation from becoming uncontrollable, fit the tubing with a protective cover or fix it in place.

### Caution

#### 1. Preparation before piping

Before piping is connected, it should be thoroughly blown out with air (flushing) or washed to remove chips, cutting oil and other debris from inside the pipe.

#### 2. Winding of sealant tape

When screwing together pipes and fittings, etc., be certain that chips from the pipe threads and sealant do not get inside the pipe.

Also, when the sealant tape is used, leave approx. 1 thread ridge exposed at the end of the threads.

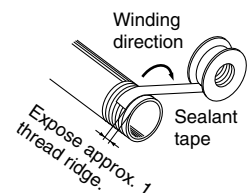

#### 3. Check the model, type and size before installation.

Also, confirm that there is no scratches, gouges or cracks on the product.

#### 4. When connecting the tubing, take pressure or possible changes to the tubing length into account, and allow a sufficient margin.

Failure to do so may result in fitting breakage or detachment of the tubing. Refer to the recommended piping conditions.

#### 5. Do not apply unnecessary forces such as twisting, pulling, moment loads, vibration and impact, etc. on fittings or tubing.

This will cause damage to fittings and will crush, burst or release tubing.

#### 6. Tubing, with the exception of coiled tubing, requires stationary installation. Do not use standard tubing (non-coiled) in applications where tubing is required to travel inside the flexible moving tube. Tubing that travels may sustain abrasion, extension, or severance due to tensile force, or may result in removal of tubing from fitting. Use caution prior to use for proper application.

#### 7. To install the fitting, screw the fitting into the hexagonal face of the body, and tighten with an appropriate wrench.

Affix the wrench at the base of the thread. If the size of hexagonal face and wrench do not match, or tightening takes place near the tube side, it may cause collapse or deformation of the hexagonal face, or damage to the equipment. After installing, confirm that there is no damage to the fitting etc.



# Fittings & Tubing Precautions 2

Be sure to read this before handling products.

## Mounting / Piping

### ⚠ Caution

#### 8. Interference in oval type release button

The following models cannot be used if a box wrench or socket wrench is used.

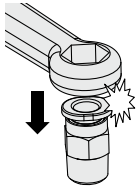

#### KQ2 Series

Model	Applicable tubing	Connection thread	Part number
Male connector	ø3.2	M3 x 0.5	KQ2H23-M3G1
	ø3.2	M5 x 0.8	KQ2H23-M5□1
	ø4	M3 x 0.5	KQ2H04-M3G1
	ø4	M5 x 0.8	KQ2H04-M5□1
	ø4	M6 x 1.0	KQ2H04-M6□1
	ø6	M5 x 0.8	KQ2H06-M5□1
	ø6	M6 x 1.0	KQ2H06-M6□1
	ø6	R1/8	KQ2H06-01□S1
	ø1/8	10-32UNF	KQ2H01-32□1
	ø5/32	10-32UNF	KQ2H03-32□1
	ø3/16	10-32UNF	KQ2H05-32□1
	ø5/32	NPT1/16	KQ2H03-33□S1
	ø1/8	M5 x 0.8	KQ2H01-M5□1
	ø3/16	M5 x 0.8	KQ2H05-M5□1
ø3/16	R1/8	KQ2H05-01□S1	
Female connector	ø4	M3 x 0.5	KQ2F04-M3□1
	ø4	M5 x 0.8	KQ2F04-M5□1
	ø6	M5 x 0.8	KQ2F06-M5□1
	ø1/8	10-32UNF	KQ2F01-32□1
	ø5/32	10-32UNF	KQ2F03-32□1
	ø1/8	M3 x 0.5	KQ2F23-M3□1
ø1/8	M5 x 0.8	KQ2F23-M5□1	

□: A (Brass), N (Brass + Electroless nickel plating)

#### KQ2-G Stainless Steel Series

Model	Applicable tubing	Connection thread	Part number
Male connector	ø4	M5 x 0.8	KQ2H04-M5G1
	ø6	M5 x 0.8	KQ2H06-M5G1
	ø6	R1/8	KQ2H06-01GS1

## Air Supply

### ⚠ Warning

#### 1. Type of fluids

Please consult with SMC when using the product in applications other than compressed air.

Regarding products for general fluids, please contact SMC concerning applicable fluids.

#### 2. When there is a large amount of drainage

Compressed air containing a large amount of drainage can cause the malfunction of pneumatic equipment. An air dryer or water droplet separator should be installed upstream from filters.

#### 3. Drain flushing

If condensation in the drain bowl is not emptied on a regular basis, the bowl will overflow and allow the condensation to enter the compressed air lines. This causes the malfunction of pneumatic equipment.

If the drain bowl is difficult to check and remove, the installation of a drain bowl with an auto drain option is recommended.

Refer to "SMC Air Preparation System" for further details on compressed air quality.

#### 4. Use clean air.

Do not use compressed air that contains chemicals, synthetic oils that include organic solvents, salt, corrosive gases, etc., as they can cause damage or malfunction.

## Air Supply

### ⚠ Caution

#### 1. Install an air filter.

Install an air filter at the upstream side of valve.

Select an air filter with a filtration degree of 5 µm or finer.

#### 2. Install an aftercooler, air dryer or water separator, etc.

Compressed air containing a large amount of drainage can cause the malfunction of pneumatic equipment. Therefore, take appropriate measures to ensure air quality, such as by providing an aftercooler, air dryer, or water separator.

#### 3. Ensure that the fluid and ambient temperature are within the specified range.

If the fluid temperature is 5°C or less, the moisture in the circuit could freeze, causing damage to the seals and leading to equipment malfunction. Therefore, take appropriate measures to prevent freezing.

Refer to "SMC Air Preparation System" for further details on compressed air quality.

## Operating Environment

### ⚠ Warning

#### 1. Do not use in an atmosphere where corrosive gases, chemicals, sea water, water, or water steam is present. Do not use in cases where there is direct contact with any of the above.

Refer to each construction drawing on the fittings and tubing material.

#### 2. Do not expose the product to direct sunlight for an extended period of time.

#### 3. Do not use in a place subject to heavy vibration and/or impact.

#### 4. Do not mount the product in locations where it is exposed to radiant heat.

#### 5. Do not use the ordinary fittings and tubing in locations where static electricity would be problematic.

It may result in the system failure and trouble. In such places, use of antistatic fittings (KA series) and antistatic tubing (TA series) are recommended.

#### 6. Do not use the ordinary fittings and tubing in locations where spatter is generated.

Spattering may result in a fire hazard. In such a place, use of flame resistant fittings (KR/KRM series) and flame resistant tubing (TRS/TRB series) are recommended.

#### 7. Do not use in an environment where the product is directly exposed to cutting oil, lubricant, coolant oil, etc.

Please contact SMC if using for an environment exposed to cutting oil, lubricant or coolant oil, etc.

#### 8. Take note that if nylon tubing and soft nylon tubing are used in a clean room.

The antioxidant on the surface of the soft nylon tubing may come off, thereby lowering the cleanliness level.

#### 9. Do not use in environments where foreign matter may stick to the product or get mixed in the product's interior.

This may cause leakage or disconnection of the tubing.



# Fittings & Tubing Precautions 3

Be sure to read this before handling products.

## Maintenance

### Warning

#### 1. Perform maintenance inspections according to the procedures indicated in the operation manual.

If handled improperly, malfunction and damage of machinery or equipment may occur.

#### 2. Maintenance work

If handled improperly, compressed air can be dangerous. The assembly, handling, repair, and element replacement of pneumatic systems should be performed by a knowledgeable and experienced person.

#### 3. Drain flushing

Remove drainage from air filters regularly.

#### 4. Removal of equipment and supply/exhaust of compressed air

When components are removed, first confirm that measures are in place to prevent workpieces from dropping, run-away equipment, etc. Then, cut off the supply pressure and electric power, and exhaust all compressed air from the system using the residual pressure release function.

When the equipment is restarted, proceed with caution after confirming that appropriate measures are in place to prevent cylinders from sudden movement.

### Caution

#### 1. Be certain to wear safety glasses at all times during periodical inspections.

#### 2. Replace fittings or tubing having the following problems.

- 1) Cracks, gouges, wearing, corrosion
- 2) Air leakage
- 3) Twists or crushing of tubing
- 4) Hardening, deterioration, softening of tubing

#### 3. When replacing tubes or fittings, do not try to mend or repair and then reuse them.

## One-touch Fittings

### Mounting / Piping

### Caution

#### 1. Installation and removal of tubing for One-touch fittings

##### 1) Installation of tubing

- (1) Cut the tubing perpendicularly, being careful not to damage the outside surface. Use an SMC tube cutter TK-1, 2, 3, 5 or 6. Do not cut the tubing with pliers, nippers, scissors, etc., otherwise, the tubing will be deformed and trouble may result.
- (2) The outside diameter of the polyurethane tubing swells when internal pressure is applied to it. Therefore, it may be possible that the tubing cannot be re-inserted into the One-touch fitting. Check the tubing outside diameter, and when the accuracy of the outside diameter is +0.07 mm or larger for  $\phi 2$ , +0.15 mm or larger for other sizes, insert into the One-touch fitting again, without cutting the tubing to use it. When the tubing is re-inserted into the One-touch fitting, confirm that the tubing goes through the release button smoothly.

## One-touch Fittings

### Mounting / Piping

### Caution

(3) Grasp the tubing, slowly push it straight (0 to 5°) into the One-touch fitting until it comes to a stop.

(4) Pull the tubing back gently to make sure it has a positive seal. Insufficient installation may cause air to leak or the tubing to release.

As a guide for checking the tubing is not pulled out, refer to the following table.

Tubing size	Tensile force of tubing [N]
$\phi 2$ , 3/2, 1/8"	5
$\phi 4$ , 5/32", 3/16"	8
$\phi 6$ , 1/4"	12
$\phi 8$ , 5/16"	20
$\phi 10$ , 3/8"	30
$\phi 12$ , 1/2"	35
$\phi 16$	50

#### 2) Removal of tubing

(1) Push the release button flange evenly and sufficiently to release the tube. Do not push in the tubing before pressing the release button.

(2) Pull out the tubing while keeping the release button depressed. If the release button is not held down sufficiently, the tubing cannot be withdrawn.

(3) To reuse the tubing, remove the previously lodged portion of the tubing. If the lodged portion is left on without being removed, it may result in air leakage and removal of the tubing difficult.

#### 2. Connecting products with metal rods

Products with metal rods (KC series, previous KQ series, KN series, and KM series, etc.) cannot be connected to KQ2 series One-touch fittings. If connected, the metal rod cannot be retained by the chuck of the One-touch fitting and products with metal rods may project during pressurization, causing serious personal injury or accident.

Even when products with metal rods can be connected to other One-touch fittings, do not use any tube, resin plug, or reducer after connection. This may cause releasing.

For details about One-touch fittings that can connect products with metal rods, please contact SMC.

#### 3. When mounting tubes, resin plugs, reducers, etc., do not press the release button.

Also, do not press the release button unnecessarily before mounting them. This may cause those parts to come off.

In particular, when piping products, such as plug-in elbows or reducers, etc. the release button may be pressed easily due to product handling during piping work.



# Fittings & Tubing Precautions 4

Be sure to read this before handling products.

## Connection Thread Tightening Method

### 1. Connection thread: M3

First, tighten by hand, then use a wrench appropriate for the hexagon flats of the body to tighten an additional 1/4 turn. A reference value for the tightening torque is 0.4 to 0.5 N·m.

### 2. Connection thread: M5 and 10-32UNF

First, tighten by hand, then use a wrench appropriate for the hexagon flats of the body to tighten an additional 1/6 to 1/4 turn. A reference value for the tightening torque is 1 to 1.5 N·m.

### 3. Connection thread: M6

First, tighten by hand, then use a wrench appropriate for the hexagon flats of the body to tighten an additional 1/6 to 1/4 turn.

\*: Excessive tightening may damage the thread portion or deform the gasket and cause air leakage. Insufficient tightening may loosen the threads, or cause air leakage.

### 4. Fittings with sealant: R, NPT

1. First, tighten the fitting by hand, then use a wrench appropriate for the hexagon flats of the body to tighten it a further two or three turns.

For a tightening torque guide, see the table below.

Connection thread size (R, NPT)	Tightening torque [N·m]
1/16, 1/8	3 to 5
1/4	8 to 12
3/8	15 to 20
1/2	20 to 25

2. If the fitting is tightened with excessive torque, a large amount of sealant will seep out. Remove the excess sealant.

3. Insufficient tightening may cause seal failure, or loosen the threads.

#### 4. Reuse

1) Normally, fittings with a sealant can be reused up to 2 to 3 times.

2) To prevent air leakage through the sealant, remove any loose sealant stuck to the fitting by blowing air over the threaded portion.

3) If the sealant no longer provides effective sealing, wind sealant tape over the sealant before reusing. Do not use the sealant in any form other than a tape type.

4) Once the fitting has been tightened, backing it out to its original position often causes the sealant to become defective. Air leakage will occur.

### 5. Face seal fittings: R, NPT, G

1. Tighten fittings with sealant using the proper tightening torques in the table below.

Connection thread size (R, NPT, G)	Proper tightening torque [N·m]
1/16, 1/8	3 to 5
1/4	8 to 12
3/8	15 to 20
1/2	20 to 25

2. Insufficient tightening may cause seal failure, or loosen the threads.

#### 3. Reuse

1) Normally, fittings with a sealant can be reused up to 6 to 10 times.

2) The seal ring cannot be replaced.

### 6. Uni thread fittings

1) First, tighten the threaded portion by hand, then use a proper wrench, which could be suitable for the width across flats of the hexagon body, to tighten it further at a wrench tightening angle shown below. As a reference value for the tightening torque, refer to the table below.

#### Connection Female Thread: Rc, NPT, NPTF

Uni thread size	Wrench tightening angle after hand-tightening [deg]	Tightening torque [N·m]
1/8	30 to 60	3 to 5
1/4	30 to 60	8 to 12
3/8	15 to 45	14 to 16
1/2	15 to 30	20 to 22

#### Connection Female Thread: G

Uni thread size	Wrench tightening angle after hand-tightening [deg]	Tightening torque [N·m]
1/8	30 to 45	3 to 4
1/4	15 to 30	4 to 5
3/8	15 to 30	8 to 9
1/2	15 to 30	14 to 15

2) The gasket can be reused up to 6 to 10 times. It can be replaced easily when it has sustained damage. A broken gasket can be removed by holding it and then turning it in the same direction as loosening the thread. If gasket is difficult to remove, cut it with nippers etc. In such a case, use caution not to scratch the seat face because the seat face of 45° gasket of fitting is the sealing face.

## Chamfer Dimension for Female Thread

### ⚠ Caution

#### 1. Chamfer dimension for female thread of the connection thread M3, M5, 10-32UNF

Confirming to ISO 16030 (air pressure fluid dynamics – connection – ports and stud ends), the chamfer dimensions shown below are recommended. By chamfering as shown in the following table, machining of threads is easier and effective for burr prevention.

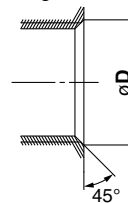

Connection thread size	Chamfer dimension øD (Recommended value) [mm]
M3	3.1 to 3.4
M5	5.1 to 5.4
10-32UNF	5.0 to 5.3

#### 2. Chamfer dimension of R and NPT thread with sealant, and Uni thread

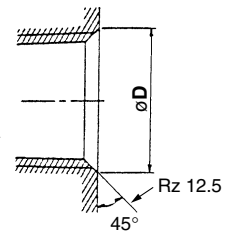

Connection thread size	Chamfer dimension øD (Recommended value)		
	G	Rc	NPT, NPTF
1/16	—	—	8.2 to 8.4
1/8	10.2 to 10.6	10.2 to 10.4	10.5 to 10.7
1/4	13.6 to 14.0	13.6 to 13.8	14.1 to 14.3
3/8	17.1 to 17.5	17.1 to 17.3	17.4 to 17.6
1/2	21.4 to 21.8	21.4 to 21.6	21.7 to 21.9

\* For Uni thread, Rz 12.5 is necessary for sealing at the chamfered part.





# Fittings & Tubing Precautions 5

Be sure to read this before handling products.

## Chamfer Dimension for Female Thread

### ⚠ Caution

#### 3. Chamfer dimension for female thread of face seal fitting (R, NPT, G)

- 1) Surface roughness of bearing surface: Rz 25 or less
- 2) Chamfer dimension:  $\phi D1$ , Seal bearing surface diameter:  $\phi D2$  (Refer to the table below.)
- 3) Female thread inclination angle:  $1^\circ$  or less
- 4) Counterbore diameter when the female thread is counterbored.:  $\phi D3$ 
  - Models with width across flats: Body width across flats x 1.1 or more
  - Models other than hexagon (Hexagon socket head male connector etc.): Body dimensions + 0.2 mm or more
- \*: The width across flats and the body dimensions differ depending on the model even when the same thread size is used. Refer to the dimensions in the catalog.
- 5) If oil content or sealant is sticking to the female thread, this may cause damage of the product. Remove it before piping.

Connection thread size	Chamfer dimension $\phi D1$ [mm]	Seal bearing surface diameter $\phi D2$ [mm]
R1/8	10.2 to 10.4	12 or more
R1/4	13.6 to 13.8	17 or more
R3/8	17.1 to 17.3	21 or more
R1/2	21.4 to 21.6	27 or more
NPT1/16	8.2 to 8.4	11.11 or more
NPT1/8	10.5 to 10.7	12.7 or more
NPT1/4	14.1 to 14.3	17.46 or more
NPT3/8	17.4 to 17.6	22 or more
NPT1/2	21.7 to 21.9	28.7 or more
G1/8	10.2 to 10.6	12 or more
G1/4	13.6 to 14.0	17 or more
G3/8	17.1 to 17.5	21 or more
G1/2	21.4 to 21.8	27 or more

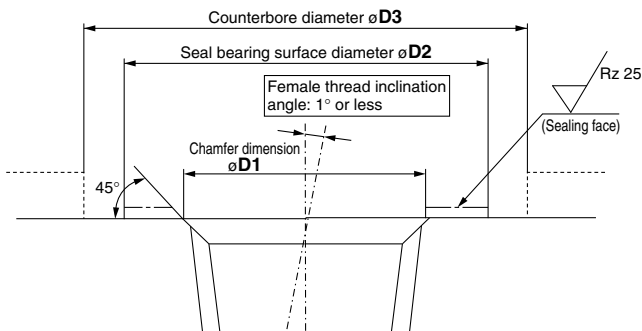

## Recommended Piping Conditions

1. When connecting piping to the One-touch fitting, use pipe length with sufficient margin, in accordance with the piping conditions shown in Fig. 1.

Also, when using a tying band etc., to bind the piping together, make sure that external force does not come to bear on the fitting. (See Fig. 2.)

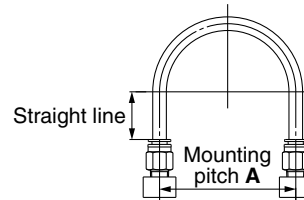

Fig. 1 Recommended piping

Unit: [mm]

Tubing size	Mounting pitch A			Straight line length
	Nylon tubing	Soft nylon tubing	Polyurethane tubing	
$\phi 2$	—	—	13 or more	10 or more
$\phi 3.2, 1/8"$	44 or more	35 or more	25 or more	16 or more
$\phi 4, 5/32"$	56 or more	44 or more	26 or more	20 or more
$\phi 3/16"$	67 or more	52 or more	38 or more	24 or more
$\phi 6$	84 or more	66 or more	39 or more	30 or more
$\phi 1/4"$	89 or more	70 or more	57 or more	32 or more
$\phi 8, 5/16"$	112 or more	88 or more	52 or more	40 or more
$\phi 10$	140 or more	110 or more	69 or more	50 or more
$\phi 3/8"$	134 or more	105 or more	69 or more	48 or more
$\phi 12$	168 or more	132 or more	88 or more	60 or more
$\phi 1/2"$	178 or more	140 or more	93 or more	64 or more
$\phi 16$	224 or more	176 or more	114 or more	80 or more

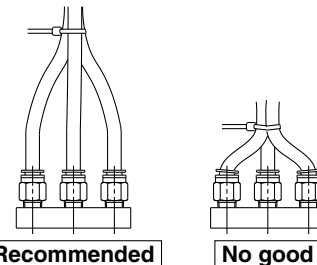

Fig. 2 When using a tying band to bind the piping together

## Tubing

### Design / Selection

### ⚠ Caution

1. When using a tubing other than from SMC, be careful of the tolerance of the tubing O.D. and tubing material.

- 1) Nylon tubing Within  $\pm 0.1$  mm
- 2) Soft nylon tubing Within  $\pm 0.1$  mm
- 3) Polyurethane tubing Within  $+0.15$  mm, Within  $-0.2$  mm

Do not use the tubing which does not satisfy the specified tubing O.D. accuracy, or if the tubing has a different I.D., material, hardness, or surface roughness from those of SMC's tubing. Please consult SMC if there is anything unclear. It may cause difficulty in connecting the tubing, leakage, disconnection of the tubing, or fitting damage.

When used with tubing other than those from SMC, due to their properties, the products listed below are not subject to warranty.

KQG2, KQB2, KFG2, KF,  $\phi 2M$

2. When using fittings other than those from SMC, be certain to confirm that operating conditions are such that no problems will arise.





## KQ2C Series

# Notes when Ordering Color Caps

In order to improve operability, the outside diameter of the release button has been enlarged for the **new KQ2** series. Therefore, the usable color caps will differ between pre-change and post-change products. Please contact SMC if anything is unclear.

### Applicable Sizes and Models

	Applicable tubing O.D.	Model
Metric size	ø8, ø10, ø12, ø16	All models*1
Inch size	ø1/4", ø3/8", ø1/2"	

\*1: Excluding models without release buttons

### How to Identify Release Buttons Before and After Change

The release button for both the fitting/**KQ2** and color cap/**KQ2C** after the change can be identified by the protruding mark on the left side of the **SMC** logo, and the release button before the change has no protruding mark. The same identification method is used for metric size and inch size.

\*: Along with the change of the release button, the model of the color cap/**KQ2C** is changed from **KQ2C-□A** to **KQ2C-□B**.

\*: There is no change of the model for the fitting/**KQ2**.

#### Before change

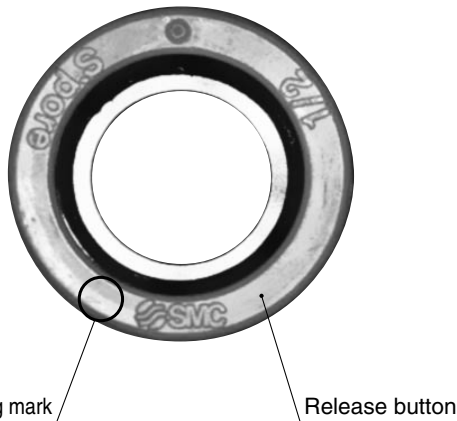

#### After change

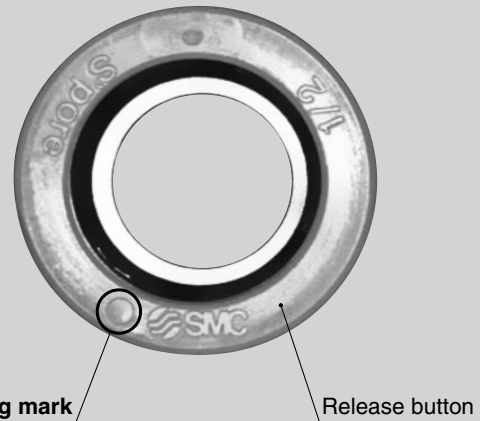

#### Applicable color cap

##### Metric Size

Applicable tubing O.D. [mm]	Model	øD1	øD2	L	Weight [g]
ø8	<b>KQ2C-08□A</b>	12.8	9.2	2.6	0.1
ø10	<b>KQ2C-10□A</b>	15.2	11.2	2.7	0.1
ø12	<b>KQ2C-12□A</b>	17.6	13.2	2.7	0.1
ø16	<b>KQ2C-16□A</b>	22.4	17.2	3.2	0.2

□: B (Black), R (Red), YR (Orange), BR (Brown), Y (Yellow), G (Green), CB (Sky blue), GR (Gray), W (White), BU (Blue)

##### Inch Size

Applicable tubing O.D. [inch]	Model	øD1	øD2	L	Weight [g]
ø1/4	<b>KQ2C-07□A</b>	10.7	7.5	2.6	0.1
ø3/8	<b>KQ2C-11□A</b>	14.8	10.7	2.7	0.1
ø1/2	<b>KQ2C-13□A</b>	18.5	13.9	2.7	0.1

□: B (Black), R (Red), YR (Orange), BR (Brown), Y (Yellow), G (Green), CB (Sky blue), GR (Gray), W (White), BU (Blue)

#### Applicable color cap

##### Metric Size

Applicable tubing O.D. [mm]	Model	øD1	øD2	L	Weight [g]
ø8	<b>KQ2C-08□B</b>	13.6	9.2	2.6	0.1
ø10	<b>KQ2C-10□B</b>	16.2	11.2	2.7	0.1
ø12	<b>KQ2C-12□B</b>	18.8	13.2	2.7	0.2
ø16	<b>KQ2C-16□B</b>	24.2	17.2	3.2	0.3

□: B (Black), R (Red), YR (Orange), BR (Brown), Y (Yellow), G (Green), CB (Sky blue), GR (Gray), W (White), BU (Blue)

##### Inch Size

Applicable tubing O.D. [inch]	Model	øD1	øD2	L	Weight [g]
ø1/4	<b>KQ2C-07□B</b>	11.5	7.5	2.6	0.1
ø3/8	<b>KQ2C-11□B</b>	15.7	10.7	2.7	0.1
ø1/2	<b>KQ2C-13□B</b>	19.6	13.9	2.7	0.2

□: B (Black), R (Red), YR (Orange), BR (Brown), Y (Yellow), G (Green), CB (Sky blue), GR (Gray), W (White), BU (Blue)

## Safety Instructions

These safety instructions are intended to prevent hazardous situations and/or equipment damage. These instructions indicate the level of potential hazard with the labels of “**Caution**,” “**Warning**” or “**Danger**.” They are all important notes for safety and must be followed in addition to International Standards (ISO/IEC)\*1), and other safety regulations.

 **Caution:** **Caution** indicates a hazard with a low level of risk which, if not avoided, could result in minor or moderate injury.

 **Warning:** **Warning** indicates a hazard with a medium level of risk which, if not avoided, could result in death or serious injury.

 **Danger:** **Danger** indicates a hazard with a high level of risk which, if not avoided, will result in death or serious injury.

\*1) ISO 4414: Pneumatic fluid power – General rules relating to systems.  
ISO 4413: Hydraulic fluid power – General rules relating to systems.  
IEC 60204-1: Safety of machinery – Electrical equipment of machines.  
(Part 1: General requirements)  
ISO 10218-1: Manipulating industrial robots – Safety.  
etc.

### Warning

#### 1. The compatibility of the product is the responsibility of the person who designs the equipment or decides its specifications.

Since the product specified here is used under various operating conditions, its compatibility with specific equipment must be decided by the person who designs the equipment or decides its specifications based on necessary analysis and test results. The expected performance and safety assurance of the equipment will be the responsibility of the person who has determined its compatibility with the product. This person should also continuously review all specifications of the product referring to its latest catalog information, with a view to giving due consideration to any possibility of equipment failure when configuring the equipment.

#### 2. Only personnel with appropriate training should operate machinery and equipment.

The product specified here may become unsafe if handled incorrectly. The assembly, operation and maintenance of machines or equipment including our products must be performed by an operator who is appropriately trained and experienced.

#### 3. Do not service or attempt to remove product and machinery/equipment until safety is confirmed.

1. The inspection and maintenance of machinery/equipment should only be performed after measures to prevent falling or runaway of the driven objects have been confirmed.
2. When the product is to be removed, confirm that the safety measures as mentioned above are implemented and the power from any appropriate source is cut, and read and understand the specific product precautions of all relevant products carefully.
3. Before machinery/equipment is restarted, take measures to prevent unexpected operation and malfunction.

#### 4. Contact SMC beforehand and take special consideration of safety measures if the product is to be used in any of the following conditions.

1. Conditions and environments outside of the given specifications, or use outdoors or in a place exposed to direct sunlight.
2. Installation on equipment in conjunction with atomic energy, railways, air navigation, space, shipping, vehicles, military, medical treatment, combustion and recreation, or equipment in contact with food and beverages, emergency stop circuits, clutch and brake circuits in press applications, safety equipment or other applications unsuitable for the standard specifications described in the product catalog.
3. An application which could have negative effects on people, property, or animals requiring special safety analysis.
4. Use in an interlock circuit, which requires the provision of double interlock for possible failure by using a mechanical protective function, and periodical checks to confirm proper operation.

### Caution

#### 1. The product is provided for use in manufacturing industries.

The product herein described is basically provided for peaceful use in manufacturing industries.  
If considering using the product in other industries, consult SMC beforehand and exchange specifications or a contract if necessary.  
If anything is unclear, contact your nearest sales branch.

### Limited warranty and Disclaimer/ Compliance Requirements

The product used is subject to the following “Limited warranty and Disclaimer” and “Compliance Requirements”.

Read and accept them before using the product.

#### Limited warranty and Disclaimer

1. The warranty period of the product is 1 year in service or 1.5 years after the product is delivered, whichever is first.\*2)  
Also, the product may have specified durability, running distance or replacement parts. Please consult your nearest sales branch.
2. For any failure or damage reported within the warranty period which is clearly our responsibility, a replacement product or necessary parts will be provided.  
This limited warranty applies only to our product independently, and not to any other damage incurred due to the failure of the product.
3. Prior to using SMC products, please read and understand the warranty terms and disclaimers noted in the specified catalog for the particular products.

##### \*2) Vacuum pads are excluded from this 1 year warranty.

A vacuum pad is a consumable part, so it is warranted for a year after it is delivered.  
Also, even within the warranty period, the wear of a product due to the use of the vacuum pad or failure due to the deterioration of rubber material are not covered by the limited warranty.

#### Compliance Requirements

1. The use of SMC products with production equipment for the manufacture of weapons of mass destruction (WMD) or any other weapon is strictly prohibited.
2. The exports of SMC products or technology from one country to another are governed by the relevant security laws and regulations of the countries involved in the transaction. Prior to the shipment of a SMC product to another country, assure that all local rules governing that export are known and followed.

### Caution

#### SMC products are not intended for use as instruments for legal metrology.

Measurement instruments that SMC manufactures or sells have not been qualified by type approval tests relevant to the metrology (measurement) laws of each country. Therefore, SMC products cannot be used for business or certification ordained by the metrology (measurement) laws of each country.

## Safety Instructions

Be sure to read the “Handling Precautions for SMC Products” (M-E03-3) and “Operation Manual” before use.