

Air Slide Table/High Rigidity Type

ø32

RoHS

A linear guide with a 4-row circular arc groove for high rigidity and high precision

**Table displacement:
Reduced by 50%**

* 0.022 mm → 0.011 mm

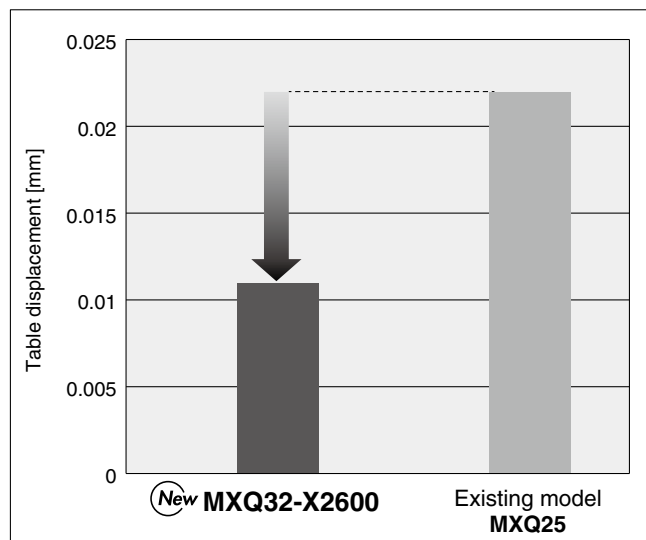

* Displacement of part F (indicated in the figure on the right) when 100 N of load is applied to part F during a 30 mm stroke
 * In accordance with SMC's test conditions
 * Refer to page 4 for details on table displacement.

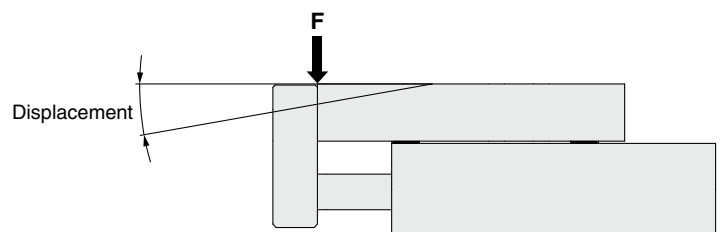
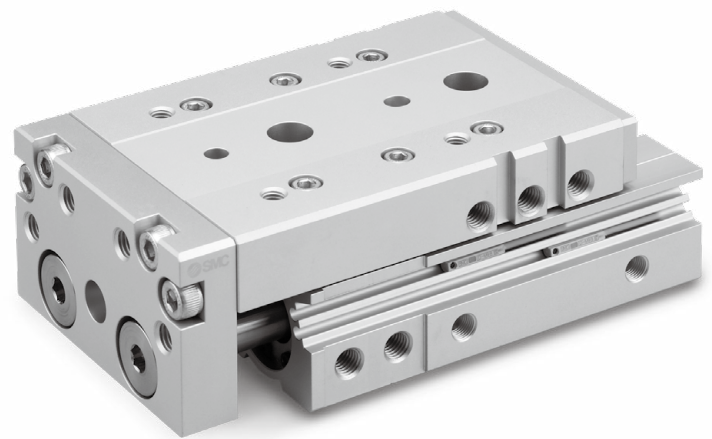

* Measurement at extension stroke end

■ **Max. load mass: 160 N**

■ **Aluminum table:
Load weight increased by
reducing the weight of
moving parts**

■ **Integrated pilot port, stroke
adjuster, and auto switch on 1 side
allows for improved operability**

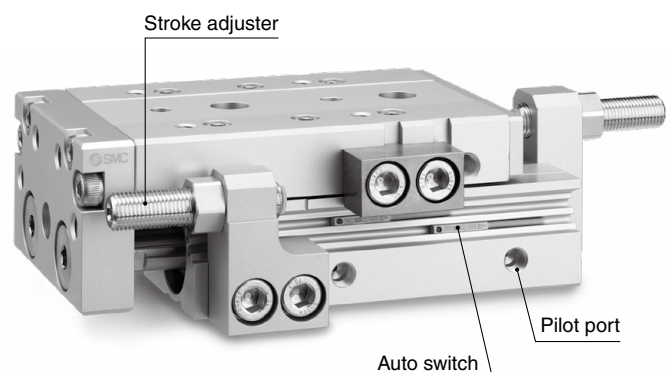

MXQ32-X2600

SMC

21-E773

Air Slide Table/High Rigidity Type

MXQ32-X2600

ø32



How to Order

MXQ 32 - 30 AS - M9BW - [] - [] - X2600

Bore size

Standard stroke [mm]
10, 20, 30, 40, 50

Adjuster option

Symbol	Adjuster type	Adjuster mounting position	
		Extension stroke end	Retraction stroke end
Nil	Without adjuster	—	—
AS	Rubber stopper	●	—
AT		—	●
A		●	●
BS		●	—
BT	Shock absorber/RJ	—	●
B		●	●
ASBT	Extension stroke end rubber stopper + Retraction stroke end shock absorber	●	●
BSAT	Extension stroke end shock absorber + Retraction stroke end rubber stopper	●	●

* Refer to pages 9 and 10 for the adjuster adjustment range.
* The "-X12" long adjustment bolt specification is not available for the 10 mm standard stroke type.

Made to order

Nil	None
-X11	Long adjustment bolt (10 mm longer adjuster adjustment range)
-X12	Long adjustment bolt (20 mm longer adjuster adjustment range)
-X33	Without built-in auto switch magnet
-X42	Anti-corrosive guide unit
-X42A	Anti-corrosive guide unit + Long adjustment bolt (10 mm longer adjuster adjustment range)
-X42B	Anti-corrosive guide unit + Long adjustment bolt (20 mm longer adjuster adjustment range)

* Refer to page 13 for details.

Number of auto switches

Nil	2
S	1
n	n

Auto switch

Nil	Without auto switch (Built-in magnet)
-----	---------------------------------------

* For applicable auto switches, refer to the table below.

Applicable Auto Switches/Refer to the Web Catalog for further information on auto switches.

Type	Special function	Electrical entry	Indicator light	Wiring (Output)	Load voltage		Auto switch model		Lead wire length [m]				Pre-wired connector	Applicable load						
					DC	AC	Perpendicular	In-line	0.5 (Nil)	1 (M)	3 (L)	5 (Z)								
Solid state auto switch	—	Grommet	Yes	3-wire (NPN)	24 V	5 V, 12 V	—	M9NV	M9N	●	●	●	○	○	IC circuit	Relay, PLC				
				3-wire (PNP)				M9PV	M9P	●	●	●	○							
	2-wire			5 V, 12 V	M9BV	M9B	●	●	●	○	○									
	3-wire (NPN)				M9NVV	M9NV	●	●	●	○										
	Diagnostic indication (2-color indicator)			3-wire (PNP)	M9PWV	M9PW	●	●	●	○	○									
				2-wire	M9BWW	M9BW	●	●	●	○										
	Water resistant (2-color indicator)			—	3-wire (NPN)	24 V	5 V, 12 V	—	M9NAV*1	M9NA*1	○	○	●	○	○		○	IC circuit		
					3-wire (PNP)				M9PAV*1	M9PA*1	○	○	●	○						
2-wire		M9BAV*1	M9BA*1		○				○	●	○									
—		—	—		—				—	—	—									
Reed auto switch	—	Grommet	Yes	3-wire (Equiv. to NPN)	24 V	5 V	—	A96V	A96	●	—	●	—	—	IC circuit	—				
				No				2-wire	100 V	A93V*2	A93	●	●				●	●	—	Relay, PLC
										100 V or less	A90V	A90	●				—	●		

*1 Water-resistant type auto switches can be mounted on the above models, but SMC cannot guarantee water resistance.

*2 The 1 m lead wire is only applicable to the D-A93.

* Lead wire length symbols: 0.5 m Nil (Example) M9NW
1 m M (Example) M9NWM
3 m L (Example) M9NWL
5 m Z (Example) M9NWZ

* Solid state auto switches marked with a "○" are produced upon receipt of order.
* Since there are applicable auto switches other than those listed above, refer to the Web Catalog for details.
* For details on auto switches with pre-wired connectors, refer to the Web Catalog.
* Auto switches are shipped together with the product but do not come assembled.

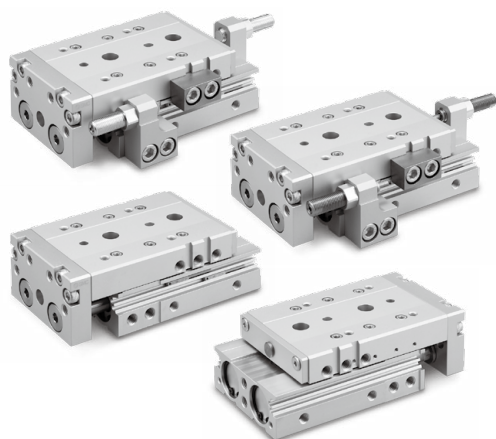

Specifications

Bore size		32
Piping port size		Rc1/8
Fluid		Air
Action		Double acting
Operating pressure		0.15 to 0.7 MPa
Proof pressure		1.05 MPa
Ambient and fluid temperatures		-10 to 60°C (No freezing)
Operating speed range (Average operating speed)		50 to 500 mm/s
Cushion	Without adjuster	Internal rubber bumper
	With adjuster	Rubber stopper, Shock absorber
Lubrication		Non-lube
Auto switch		Solid state auto switch, Reed auto switch (2-wire, 3-wire) 2-color indicator solid state auto switch (2-wire, 3-wire)
Stroke length tolerance		+2 to 0 mm

* For details on auto switches, refer to the **Web Catalog**.

Adjuster Specifications (Option)

Rubber Stopper

Max. absorbed energy [J]	0.78
Mounting screw size [mm]	M14 x 1.5
Weight [g]	65

Shock Absorber/RJ

Max. absorbed energy [J]	10
Stroke absorption [mm]	12
Operating speed range [mm/s]	50 to 500
Max. operating frequency [cycle/min]	45
Max. allowable thrust [N]	814
Spring force (Extended) [N]	6.4
Spring force (Compressed) [N]	17.4
Mounting screw size [mm]	M14 x 1.5

Theoretical Output

The dual rod ensures an output twice that of existing cylinders.

Rod size [mm]	Operating direction	Piston area [mm ²]	Operating pressure [MPa]					
			0.2	0.3	0.4	0.5	0.6	0.7
16	OUT	1608	322	483	643	804	965	1126
	IN	1206	241	362	483	603	724	844

Weight

Standard stroke [mm]		Additional weight of adjuster option	
10, 20, 30	40, 50	Extension stroke end	Retraction stroke end
3400	3600	360	250

MXQ32-X2600

Weight of Moving Parts

Standard stroke [mm]		Additional weight of adjuster option [g]	
10, 20, 30	40, 50	Extension stroke end	Retraction stroke end
1600	1780	140	75

Maximum Load Weight

Without adjuster	Adjuster option [kg]		
Internal rubber bumper	Rubber stopper	Shock absorber/RJ	
		Horizontal	Vertical
16	16	16	16

Allowable Kinetic Energy

Without adjuster	Adjuster option [J]		
Internal rubber bumper	Rubber stopper	Shock absorber/RJ	
		Horizontal	Vertical
0.78	0.78	1.9	1.9

* When selecting a model, refer to Model Selection on page 5. Keep in mind that a model cannot be selected with only the allowable kinetic energy.

Table Accuracy (Reference Values)

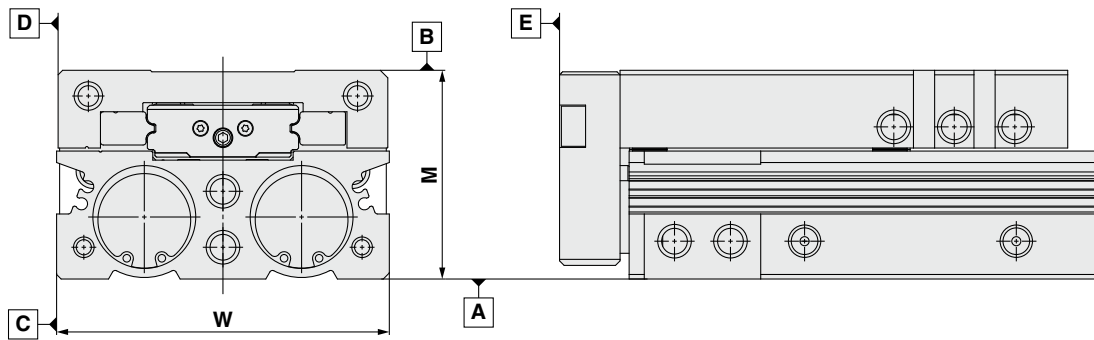

Stroke	10	20	30	40	50
B side parallelism to A side		0.085		0.095	
D side parallelism to C side		0.075		0.085	
B side traveling parallelism to A side	0.015	0.025	0.035	0.045	0.055
D side traveling parallelism to C side	0.015	0.025	0.035	0.045	0.055
E side perpendicularity to A side		0.105		0.115	
M dimension tolerance			±0.1		
W dimension tolerance			±0.1		

Table Displacement (Reference Values)

Table displacement due to pitch moment load

Displacement of part F when a load is applied to part F for the entire stroke

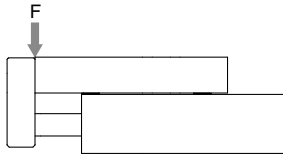

Pitch Moment

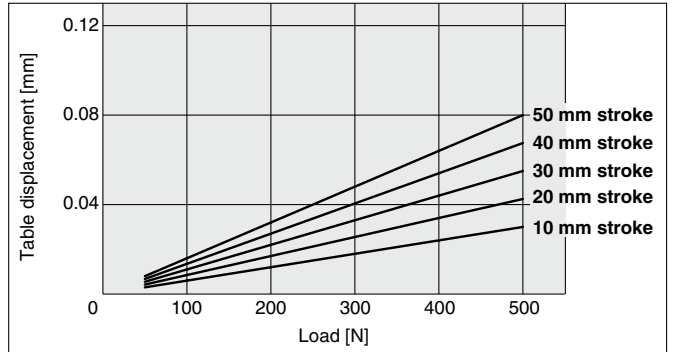
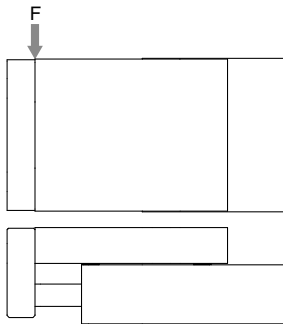

Table displacement due to yaw moment load

Displacement of part F when a load is applied to part F for the entire stroke



Yaw Moment

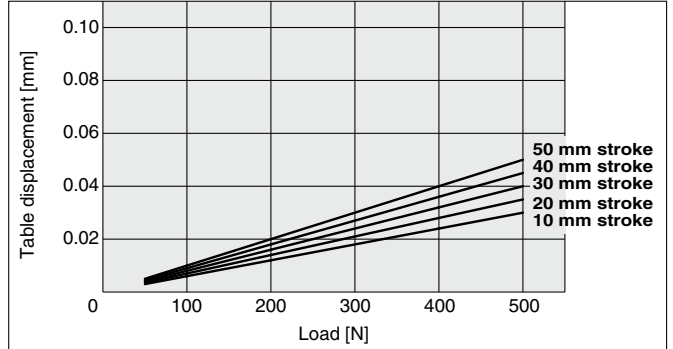
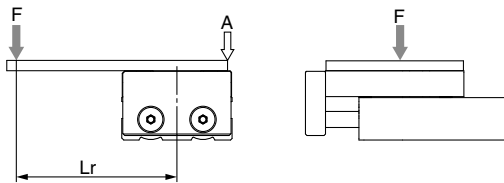
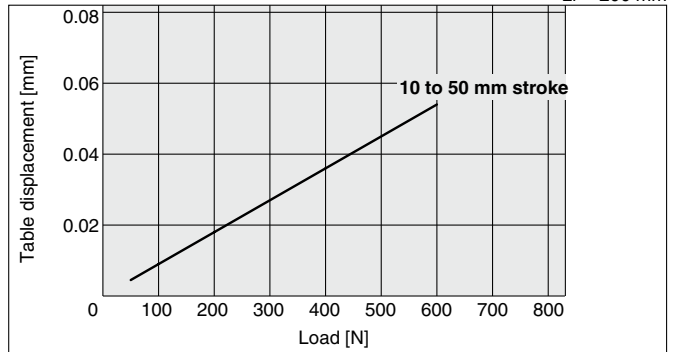

Table displacement due to roll moment load

Displacement of part A when a load is applied to part F with the air slide table retracted



Roll Moment



MXQ32-X2600

Model Selection

Model Selection Software is available.
For details, refer to Model Selection Software on the SMC website.

Selection Conditions

There are two model selection methods according to the usage. The model selection procedures are shown below. The following is a simplified selection procedure using the graphs for when an MXQ is mounted onto a static table.

For Transfer

- (1) Load mass and overhang L_1 and L_2 should be within the average speed (V_a) limit in the graphs.
- (2) For horizontal use, overhang L_3 should not exceed the allowable range. For vertical use, it is not necessary to consider L_3 as it does not affect the moment.

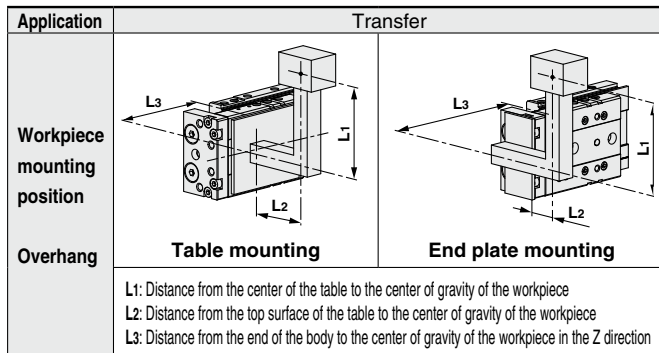

* Positional relationships among L_1 , L_2 , and L_3 do not change regardless of the body mounting direction.

MXQ32-10, 20, 30, 40, 50-X2600

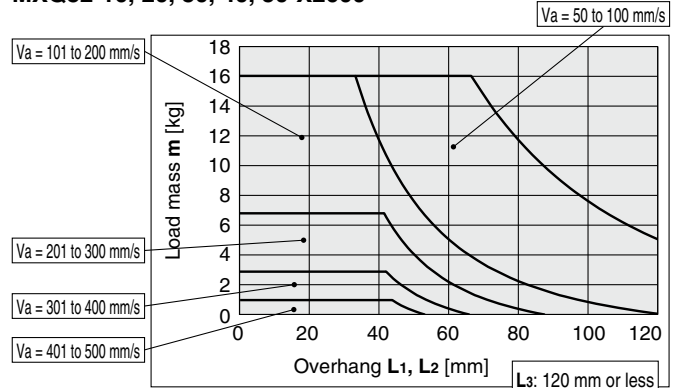

* For end plate mounting, L_2 is 1/2 of the L which is found from the graph.

* Confirm that the overhang L_1 and L_2 are within the allowable range based on the load mass and average speed.

Model Selection Steps

1 Necessary conditions

- Stroke to be used
- Load mass
- Overhang
- Average speed
- Adjuster type

2 Select a graph.

Select the applicable graph by stroke to be used and adjuster type.

When the extension stroke end and retraction stroke end use different adjuster types, check each adjuster graph to see if the adjuster can be used.

3 Determine the overhang.

Determine the overhang at the workpiece mounting positions L_1 , L_2 , and L_3 .

* Positional relationships among L_1 , L_2 , and L_3 do not change regardless of the body mounting direction.

4 Check the overhang.

Check the overhang for L_{1max} , L_{2max} , and L_{3max} during transfer.

(1) L_{1max} : Check the overhang from the cross point of the load mass and driving speed.

(2) L_{2max} : a: When mounted to the table

Check the allowable overhang from the cross point of the load mass and driving speed.

b: When mounted to the end plate

The allowable overhang is found by multiplying the allowable overhang by 1/2.

(3) L_{3max} : It is possible to use within the value in the selection graph if it is within the allowable range of the load mass and driving speed.

5 Overhang in the operating conditions

This product can be used with the overhang required (L_1 , L_2 , L_3 of No. 3) if it is within the allowable overhang range (L_{1max} , L_{2max} , L_{3max} of No. 4).

* When the required overhang exceeds the allowable overhang, review the overhang, load mass, driving speed, etc., and reconfirm that they are acceptable.

MXQ32-10, 20, 30, 40, 50-X2600

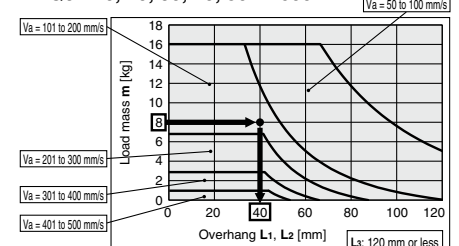

For Transfer

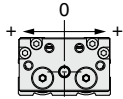

Without Adjuster

The allowable overhang L_1 for the type without an adjuster is symmetrical. Use in either direction.

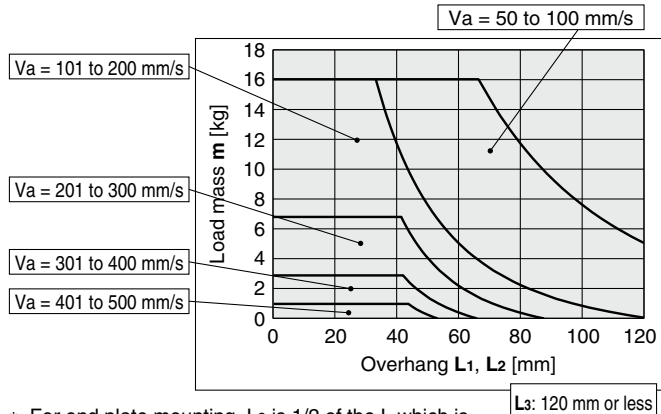

* For end plate mounting, L_2 is 1/2 of the L which is found from the graph.

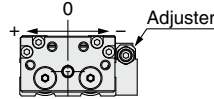

Rubber Stopper

The allowable overhang L_1 for the adjuster type is asymmetrical. The adjuster side is the "-" direction.

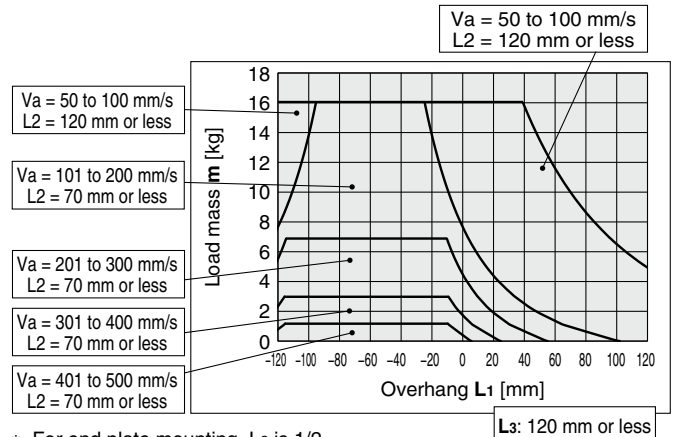

* For end plate mounting, L_2 is 1/2.

Shock Absorber

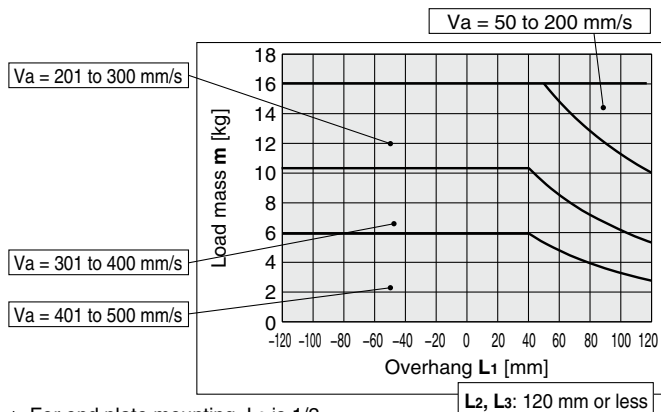

* For end plate mounting, L_2 is 1/2.

⚠ Caution

1. Operate loads within the range of the operating limits.

Select a model according to the model selection steps.

If the product is used outside of the operating limits, adverse effects such as play in the guide, degrading accuracy, and shortened product life may result.

2. If an intermediate stop is performed by an external stopper, be careful of ejection when restarting.

If lurching occurs, damage may result. If a slide table is stopped at an intermediate position by an external stopper and then moved forwards, after the slide table is returned to the back to retract the stopper, supply pressure to the opposite port to operate the slide table.

3. Do not use the product in such a way that excessive external force or impact force is applied to it.

Malfunction or damage to the table may result.

Although the table has adequate strength, if it is damaged, protect your hands with gloves. Otherwise, injury may result.

4. If the speed has been changed after setting the operating conditions, be sure to reconfirm the model selection requirements before use.

If the operating speed is increased after setting the operating conditions such as overhang and operating speed, the stopping impact force will increase, which causes an excessive moment to be generated; this will lead to the failure of the guide.

If the adjusting screw of the speed controller is loosened, the operating speed will increase, so the screw should be tightened completely.

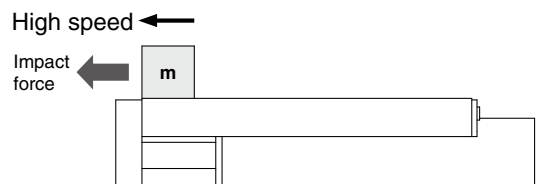

MXQ32-X2600

For Pressing (Clamping)

- (1) Confirm that the clamping attachment weight and overhang are within the allowable range as shown in the graphs for transfer.
- (2) Pressing force N and overhang L_1 and L_2 should be within the range as shown in the graphs.

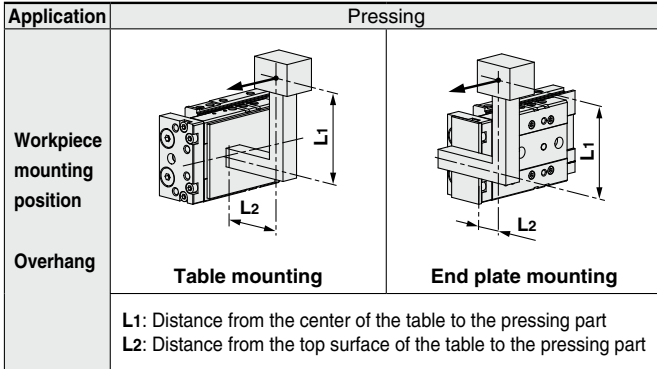

* Positional relationships between L_1 and L_2 do not change regardless of the body mounting direction.

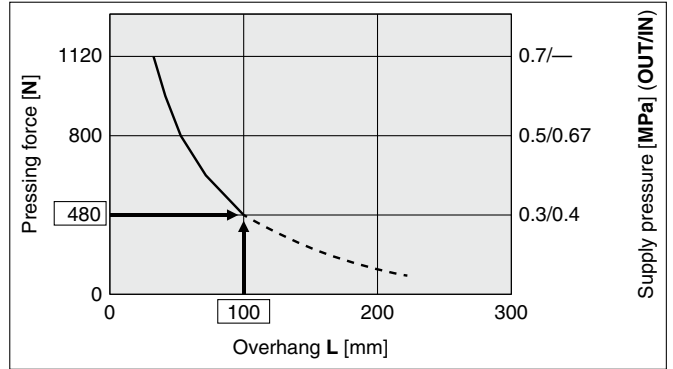

* The allowable supply pressure on the OUT and IN sides is the theoretical output of the cylinder when pressing force is required.
 * Confirm that the intersection of the pressing force and overhang L_1 is within the range as shown in the graph.

Model Selection Steps

1 Necessary conditions

- Stroke to be used
- Required pressing force or operating pressure
- Overhang

2 Select a graph.

Select the graph of the applicable workpiece mounting method.

3 Determine the overhang.

Determine the overhang at the workpiece mounting positions L_1 and L_2 .

* Positional relationships between L_1 and L_2 do not change regardless of the body mounting direction.

4 Check the allowable pressing force.

Confirm the allowable pressing force N_{max} with the overhang.

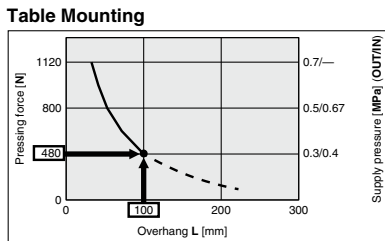

* The allowable supply pressure on the OUT and IN sides is the theoretical output of the cylinder when pressing force is required.

5 Allowable pressing force in the operating conditions

This product must be used within the allowable pressing force range.

* When the required pressing force exceeds the allowable pressing force, review the operating pressing force, operating pressure, overhang, etc., and reconfirm that they are acceptable.

Table Mounting

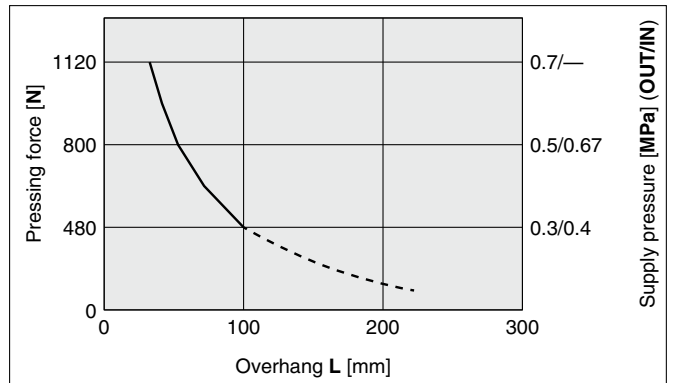

* Refer to this because there are variations in the dotted line area.

End Plate Mounting

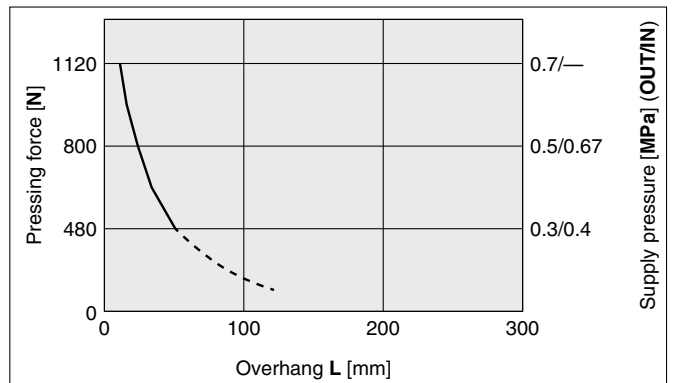

* Refer to this because there are variations in the dotted line area.

Air Slide Table/High Rigidity Type **MXQ32-X2600**

Dimensions: MXQ 32

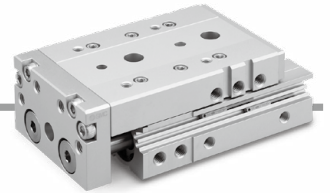

Basic type

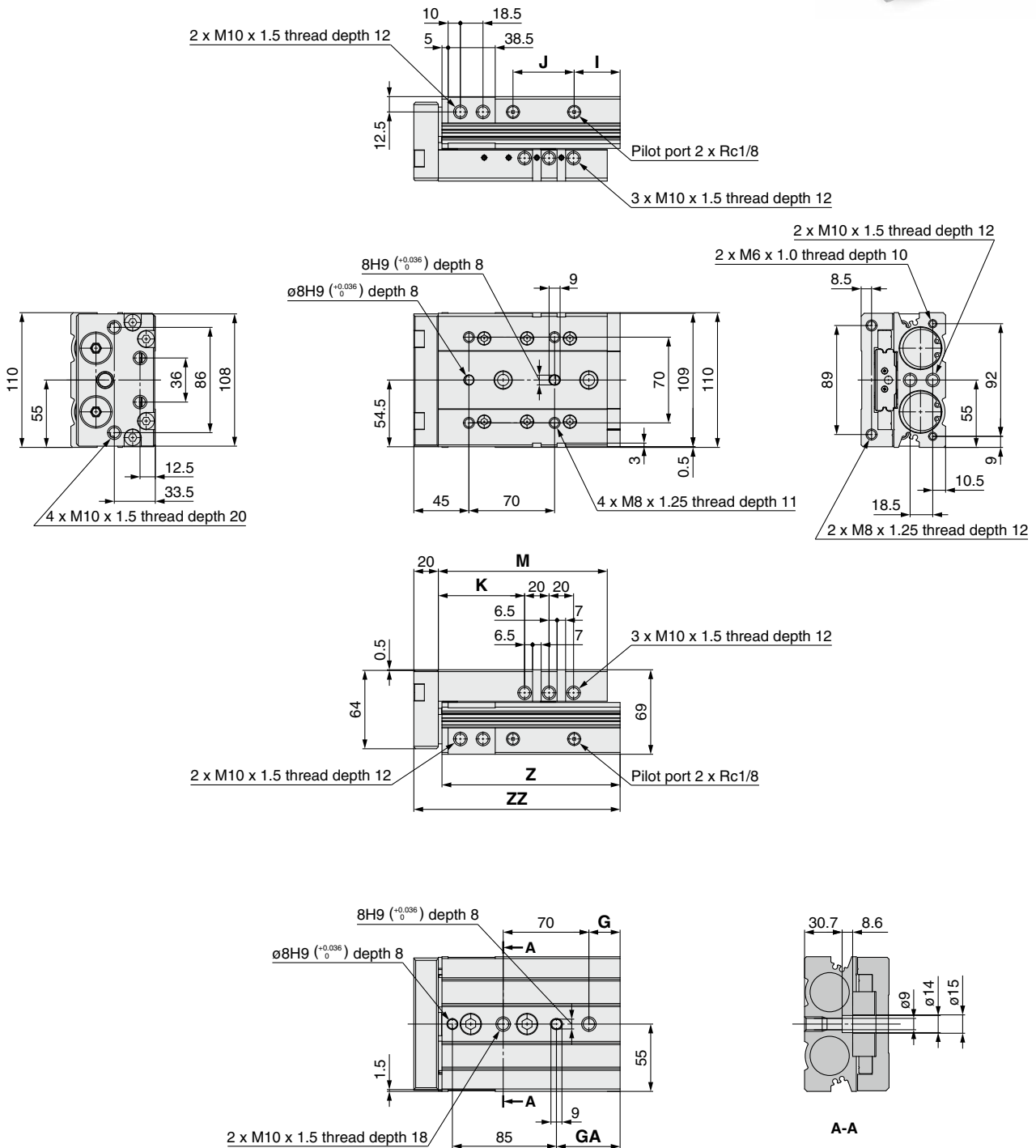

Model	G	GA	I	J	K	M	Z	ZZ
MXQ32-10-X2600								
MXQ32-20-X2600	25.5	52	37.5	50	70.5	138	145.5	168.5
MXQ32-30-X2600								
MXQ32-40-X2600	35.5	62	27.5	70	90.5	148	155.5	178.5
MXQ32-50-X2600								

MXQ32-X2600

Dimensions: MXQ **32** [Adjuster Option]

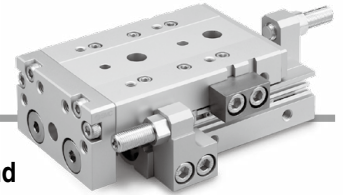

With rubber stopper **A**: Both ends, **AS**: Extension stroke end, **AT**: Retraction stroke end

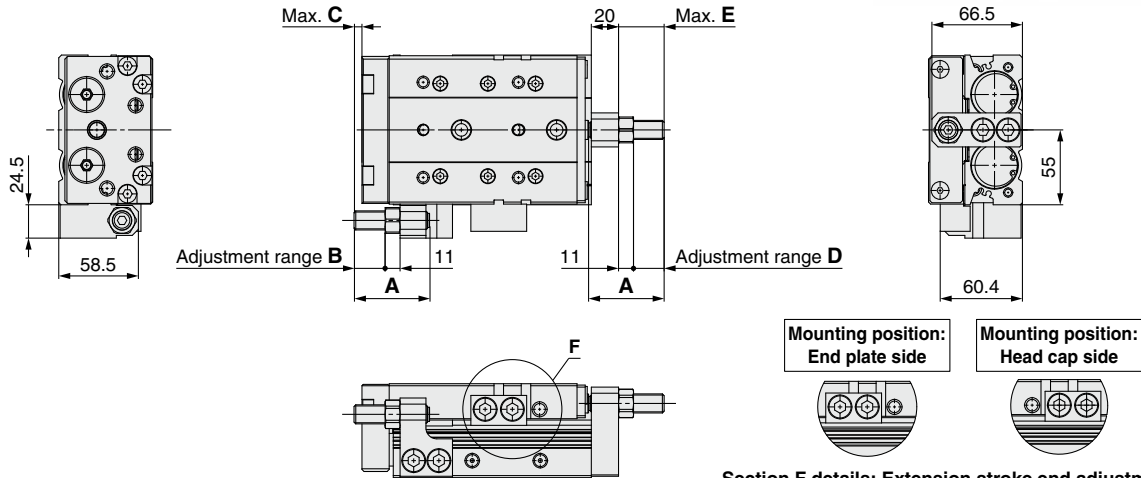

MXQ32-□□A, AS, AT-X2600 [mm]

Applicable stroke	A	Adjustment block mounting position				D	E
		End plate side		Head cap side			
		B	C	B	C		
10	65.5	10	0	—	—	30	44.5
20	55.5	10	0	—	—	20	34.5
30		20	5.5	—	—		
40		10	0	—	—		
50		20	5.5	—	—		

MXQ32-□□A, AS, AT-X11-X2600 [mm]

Applicable stroke	A	Adjustment block mounting position				D	E
		End plate side		Head cap side			
		B	C	B	C		
10	75.5	20	5.5	—	—	40	54.5
20	65.5	20	5.5	—	—	30	44.5
30		30	15.5	10	0		
40		20	5.5	—	—		
50		30	15.5	10	0		

MXQ32-□□A, AS, AT-X12-X2600 [mm]

Applicable stroke	A	Adjustment block mounting position				D	E
		End plate side		Head cap side			
		B	C	B	C		
20	75.5	30	15.5	10	0	40	54.5
30		40	25.5	20	5.5		
40		30	15.5	10	0		
50		40	25.5	20	5.5		

* The adjustable stroke range will change depending on the mounting position of the adjustment block.
 * The "-X12" long adjustment bolt specification is not available for the 10 mm standard stroke type.

Adjuster/Rubber stopper (dimensions)

Extension stroke end

Body mounting

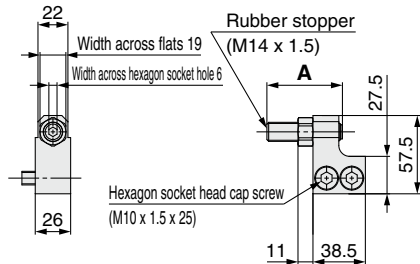
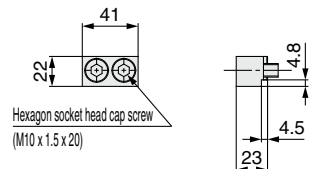

Table mounting



Retraction stroke end

Body mounting

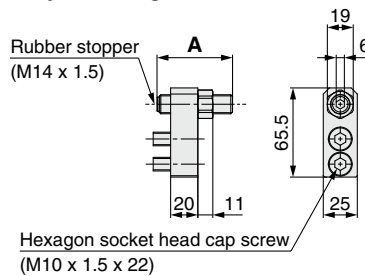
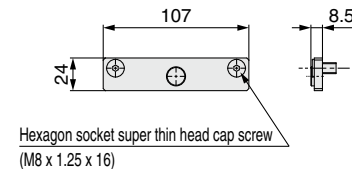
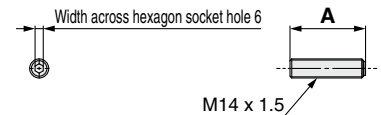

Table mounting



Adjustment bolt/Rubber stopper (Single unit)



Adjuster Part Nos. and Dimensions

Standard stroke	Model			A	
	Extension stroke end	Retraction stroke end	Rubber stopper (Single unit)		
10	Standard	MXQ-AS32-X11-X2600	MXQ-AT32-X11-X2600	MXQA-A2527-X11	65.5
	Long adjustment bolt (-X11)	MXQ-AS32-X12-X2600	MXQ-AT32-X12-X2600	MXQA-A2527-X12	75.5
20, 30, 40, 50	Standard	MXQ-AS32-X2600	MXQ-AT32-X2600	MXQA-A2527	55.5
	Long adjustment bolt (-X11)	MXQ-AS32-X11-X2600	MXQ-AT32-X11-X2600	MXQA-A2527-X11	65.5
	Long adjustment bolt (-X12)	MXQ-AS32-X12-X2600	MXQ-AT32-X12-X2600	MXQA-A2527-X12	75.5

* Adjusters for the 10 mm standard stroke type use the "-X11" long adjustment bolt specification as standard, and the "-X11" long adjustment bolt specification uses the "-X12" long adjustment bolt specification.

Dimensions: MXQ **32** [Adjuster Option]

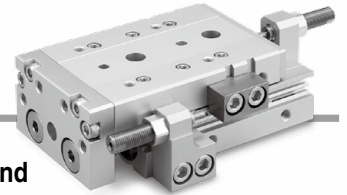

With shock absorber **B**: Both ends, **BS**: Extension stroke end, **BT**: Retraction stroke end

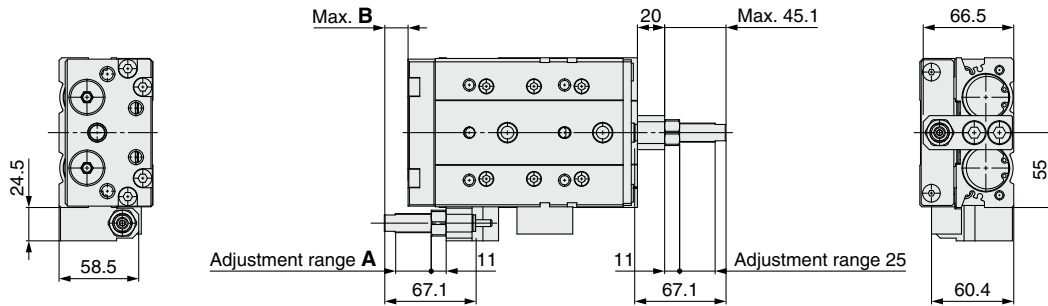

MXQ32-□□B, BS, BT-X2600 [mm]

Applicable stroke	Adjustment block mounting position			
	End plate side		Head cap side	
	A	B	A	B
10	5	0	—	—
20	15	7.1	—	—
30	25	17.1	5	0
40	15	7.1	—	—
50	25	17.1	5	0

* The adjustable stroke range will change depending on the mounting position of the adjustment block.

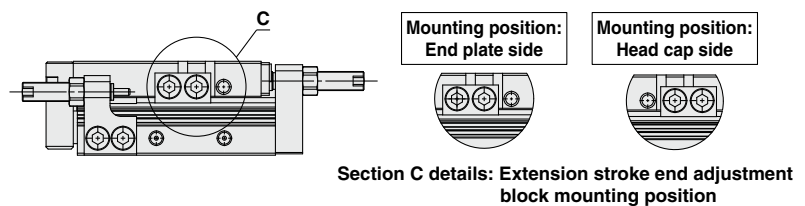

Shock absorber (dimensions)

Extension stroke end

Body mounting

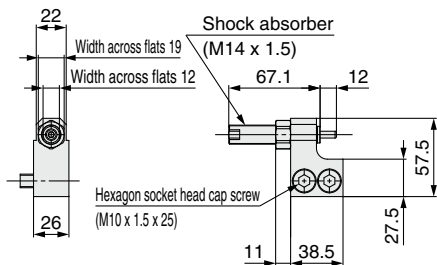

Retraction stroke end

Body mounting

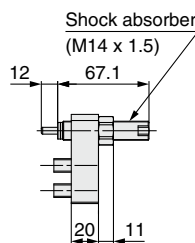

Shock absorber (Single unit)

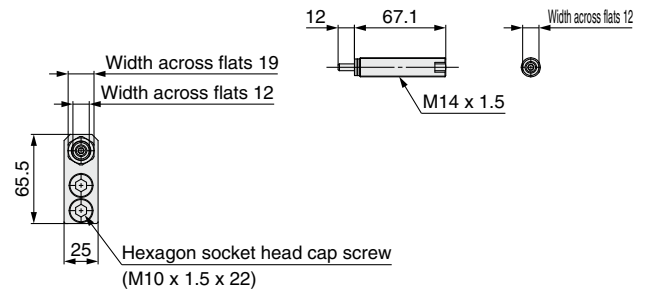

Table mounting

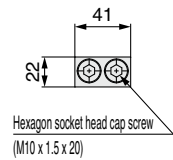
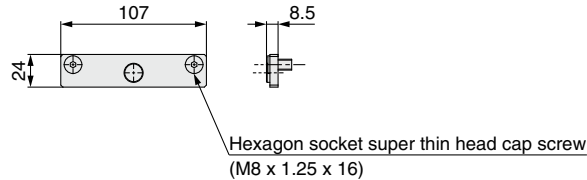

Table mounting



Model		
Extension stroke end	Retraction stroke end	Shock absorber (Single unit)
MXQ-BS32-X2600	MXQ-BT32-X2600	RJ1412LN

MXQ32-X2600

Auto Switch Mounting

Auto Switch Proper Mounting Position (Detection at stroke end)

* Adjust the auto switch after confirming the operating conditions in the actual setting.

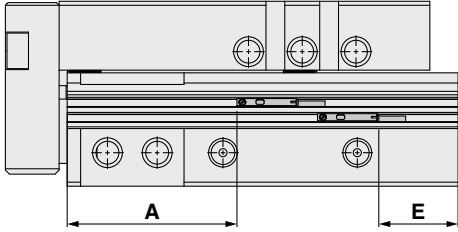

Solid State Auto Switch: D-M9□/M9□W [mm]

Model	A stroke					E stroke				
	10	20	30	40	50	10	20	30	40	50
MXQ32	76.5	66.5	56.5	66.5	56.5	36.2			26.2	

Solid State Auto Switch: D-M9□V/M9□WV [mm]

Model	A stroke					E stroke				
	10	20	30	40	50	10	20	30	40	50
MXQ32	76.5	66.5	56.5	66.5	56.5	39.2			26.2	

Solid State Auto Switch: D-M9□A [mm]

Model	A stroke					E stroke				
	10	20	30	40	50	10	20	30	40	50
MXQ32	76.5	66.5	56.5	66.5	56.5	35			25	

Solid State Auto Switch: D-M9□AV [mm]

Model	A stroke					E stroke				
	10	20	30	40	50	10	20	30	40	50
MXQ32	76.5	66.5	56.5	66.5	56.5	37			27	

Reed Auto Switch: D-A9□/A9□V [mm]

Model	A stroke					E stroke				
	10	20	30	40	50	10	20	30	40	50
MXQ32	72.5	62.5	52.5	62.5	52.5	41(38.5)			31(28.5)	

(): Denotes the values of D-A90 and A93

Auto Switch Mounting

⚠ Caution

■ Auto switch mounting direction

If the lead wire is positioned like the drawing on the left, the auto switch may malfunction. Mount the lead wire like the drawing on the right.

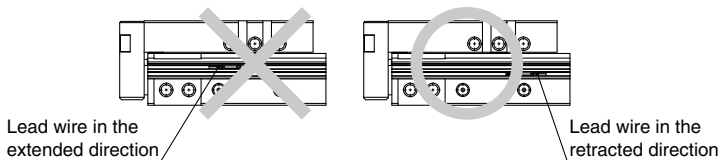

■ Auto switch mounting tool

When tightening the auto switch mounting screw (included with the auto switch), use a watchmaker's screwdriver with a handle diameter of about 5 to 6 mm.

■ Tightening torque

Auto Switch Mounting Screw Tightening Torque [N·m]

Auto switch model	Tightening torque
D-M9□(V)	0.05 to 0.15
D-M9□W(V)	
D-M9□A(V)	0.05 to 0.10
D-A9□(V)	0.10 to 0.20

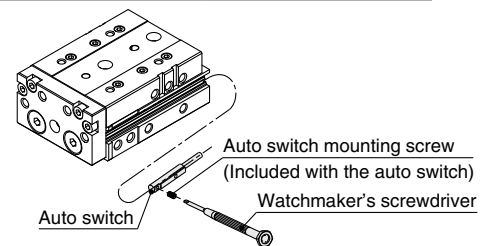

Operating Range

Auto switch model	Operating range [mm]
D-M9□(V)	5
D-M9□W(V)	
D-M9□A(V)	
D-A9□/A9□V	9.5

* Values which include hysteresis are for reference purposes only. They are not a guarantee (assuming approximately ±30% dispersion) and may change substantially depending on the ambient environment.

⚠ Caution

Allow a space of 3 mm or more if a standard type and symmetric type are used side by side. Otherwise, the auto switches may malfunction.

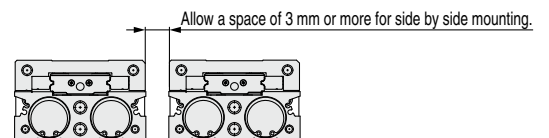

Other than the applicable auto switches listed in "How to Order," the following auto switches are also mountable.

* Normally closed (NC = b contact) solid state auto switches (D-F9G/F9H) and solid state auto switch (D-F8) are also available. For details, refer to the Web Catalog.

Prior to Use

Auto Switch Connections and Examples

Sink Input Specifications

3-wire, NPN

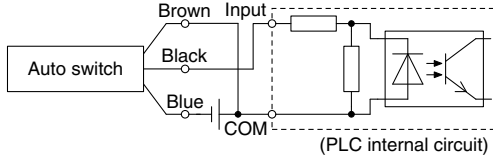

2-wire

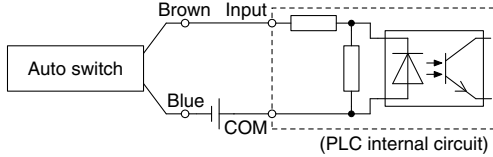

Source Input Specifications

3-wire, PNP

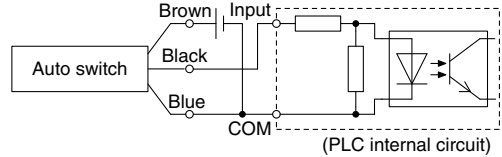

2-wire

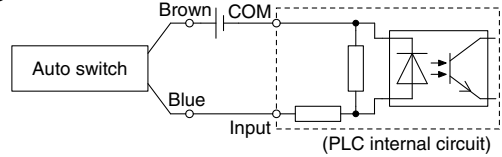

Connect according to the applicable PLC input specifications, as the connection method will vary depending on the PLC input specifications.

Examples of AND (Series) and OR (Parallel) Connections

* When using solid state auto switches, ensure the application is set up so the signals for the first 50 ms are invalid. Depending on the operating environment, the product may not operate properly.

3-wire AND connection for NPN output (Using relays)

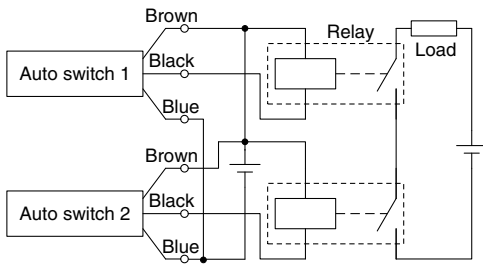

(Performed with auto switches only)

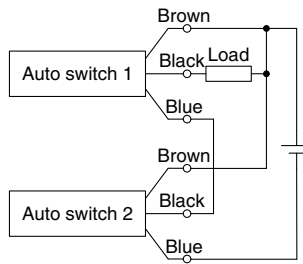

3-wire OR connection for NPN output

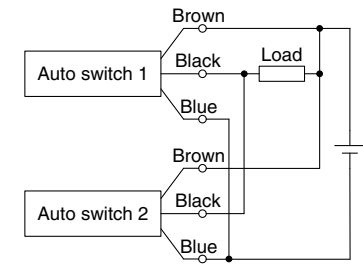

3-wire AND connection for PNP output (Using relays)

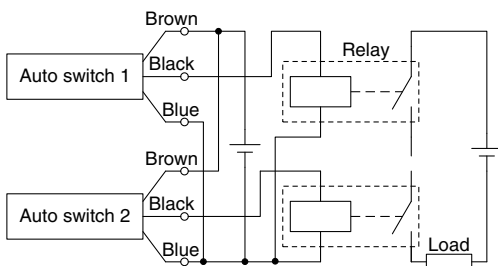

(Performed with auto switches only)

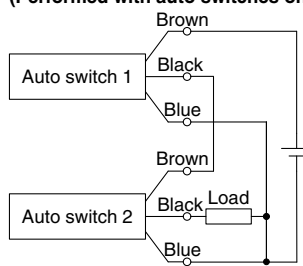

3-wire OR connection for PNP output

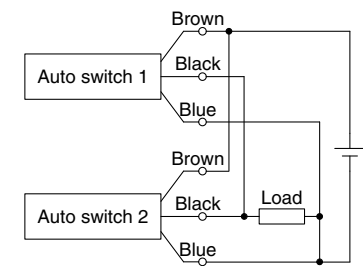

2-wire AND connection

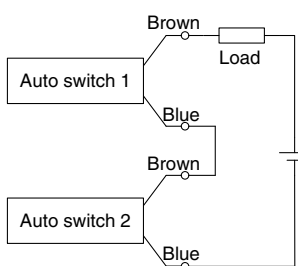

When two auto switches are connected in series, a load may malfunction because the load voltage will decline when in the ON state. The indicator lights will light up when both of the auto switches are in the ON state. Auto switches with a load voltage less than 20 V cannot be used. Please contact SMC if using AND connection for a heat-resistant solid state auto switch or a trimmer switch.

Example) Load voltage at ON
 Power supply voltage: 24 VDC
 Internal voltage drop: 4 V
 Load voltage at ON = Power supply voltage –
 Auto switch internal voltage drop x 2 pcs.
 = 24 V – 4 V x 2 pcs.
 = 16 V

2-wire OR connection

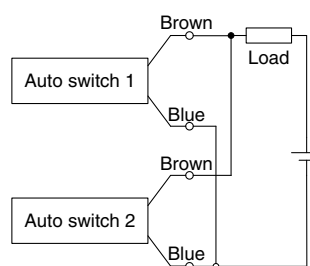

(Solid state)
 When two auto switches are connected in parallel, malfunction may occur because the load voltage will increase when in the OFF state.

(Reed)
 Because there is no current leakage, the load voltage will not increase when turned OFF. However, depending on the number of auto switches in the ON state, the indicator lights may sometimes grow dim or not light up, due to the dispersion and reduction of the current flowing to the auto switches.

Example) Load voltage at OFF
 Leakage current: 1 mA
 Load impedance: 3 kΩ
 Load voltage at OFF = Leakage current x 2 pcs. x
 Load impedance
 = 1 mA x 2 pcs. x 3 kΩ
 = 6 V

MXQ32-X2600

Made to Order

Please contact SMC for detailed dimensions, specifications, and lead times.



1 Long Adjustment Bolt (10 mm longer adjustment range) Symbol **-X11**

Rubber stopper: The stroke adjustment range has been increased by 10 mm compared with the standard product by making the adjustment bolt longer.

* Refer to the dimensions for the rubber stopper adjustment range and dimensions.

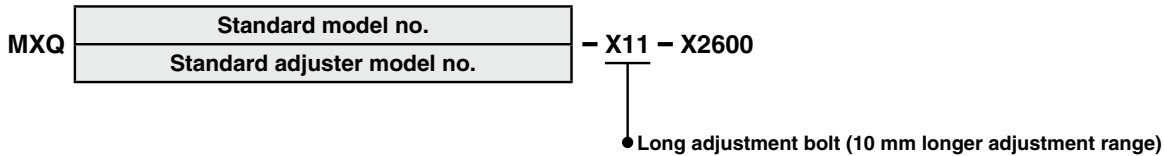

* "-X11" is not available for the shock absorber type.

* When using rubber stoppers, "-X11" applies to both the extension and retraction stroke ends.

2 Long Adjustment Bolt (20 mm longer adjustment range) Symbol **-X12**

Rubber stopper: The stroke adjustment range has been increased by 20 mm compared with the standard product by making the adjustment bolt longer.

* Refer to the dimensions for the rubber stopper adjustment range and dimensions.

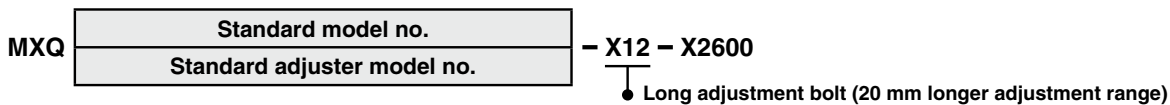

* "-X12" is not available for the shock absorber type.

* When using rubber stoppers, "-X12" applies to both the extension and retraction stroke ends.

* The "-X12" rubber stopper is not available for the 10 mm standard stroke type.

3 Without Built-in Auto Switch Magnet Symbol **-X33**

This product does not have a magnet for an auto switch.
It is suitable for applications where magnetic force is not acceptable.

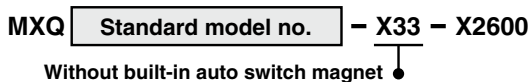

Specifications

Bore size [mm]	32
Auto switch	Not mountable

* Dimensions and specifications other than the above are the same as the standard type.

4 Anti-corrosive Guide Unit Symbol **-X42**

The guide rail and guide block are given anti-corrosive treatment.

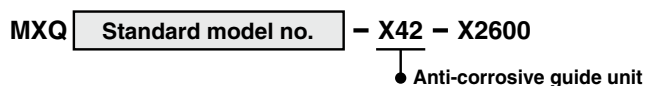

Specifications

Bore size [mm]	32
Surface treatment	Special anti-corrosive treatment*1

*1 The special anti-corrosive treatment makes the guide rail and the guide block black.

* Dimensions and specifications other than the above are the same as the standard type.

5 Anti-corrosive Guide Unit + Long Adjustment Bolt Symbol **-X42A, -X42B**

The guide rail and guide block are given anti-corrosive treatment.

Rubber stopper: The stroke adjustment range has been increased compared with the standard product by making the adjustment bolt longer.

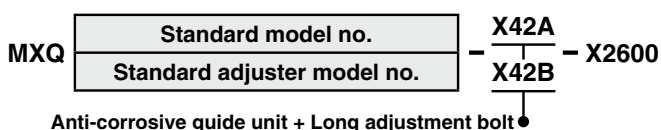

Specifications

Symbol	-X42A	-X42B
Bore size [mm]	32	
Surface treatment	Special anti-corrosive treatment*1	
Long adjustment bolt (Adjustment range)	10 mm longer	20 mm longer

*1 The special anti-corrosive treatment makes the guide rail and the guide block black.

* Dimensions and specifications other than the above are the same as the standard type.

* Refer to the dimensions for the rubber stopper adjustment range and dimensions.

* "-X42A" and "-X42B" are not available for the shock absorber type.

* When using rubber stoppers, "-X42A" and "-X42B" apply to both the extension and retraction stroke ends.

* The "-X42B" rubber stopper is not available for the 10 mm standard stroke type.



MXQ32-X2600

Specific Product Precautions 1

Be sure to read this before handling the products. For safety instructions, actuator precautions, and auto switch precautions, refer to the “Handling Precautions for SMC Products” and the “Operation Manual” on the SMC website: <https://www.smcworld.com>

Mounting

⚠ Caution

- 1. Do not scratch or dent the mounting side of the body, table, or end plate.**

This can cause a loss of parallelism in the mounting surfaces, vibration in the guide unit, increased operating resistance, etc.

- 2. Do not scratch or dent the transfer surface of the guide rail or guide block.**

This could result in looseness, increased operating resistance, etc.

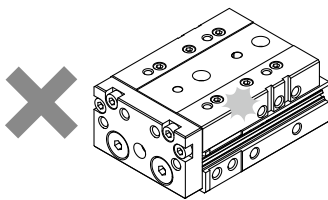

- 3. Do not apply excessive impact or loads when a workpiece is mounted.**

If an external force over the allowable moment is applied, looseness of the guide unit or increased operating resistance may occur.

- 4. Flatness of mounting surface should be 0.02 mm or less.**

Poor parallelism of the workpiece mounted on the body, the base, and other parts can cause vibration in the guide unit, increased operating resistance, etc.

- 5. Select the proper connection when connecting with a load which has external support and/or a guide mechanism on the outside, and align it properly.**

- 6. Avoid contact with the body during operation.**

Hands, etc., may get caught in the adjuster. Install a cover as a safety measure if there are instances when anyone will be near the slide table during operation.

- 7. Keep away from objects which are influenced by magnets.**

Since this product has a built-in magnet, do not allow close contact with magnetic disks, cards, or tapes. Data may be erased.

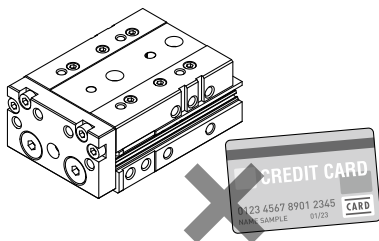

- 8. Do not touch a magnet to the guide unit.**

Since the guide unit is made from a magnetic substance, it could become magnetized if put in contact with a magnet, etc. This could cause auto switches, etc., to malfunction.

- 9. When mounting the body, use screws of the appropriate length and do not exceed the maximum tightening torque.**

Tightening with a torque above the limit could cause a malfunction. Whereas, tightening insufficiently could result in misalignment or dropping.

1. Body tapped

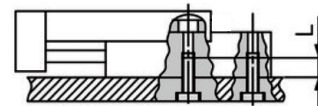

Bolt	Max. tightening torque [N·m]	Max. screw-in depth L [mm]
M10 x 1.5	29.5 to 34.5	17

2. Through hole

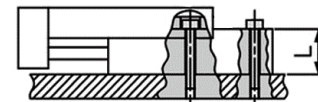

Bolt	Max. tightening torque [N·m]	L [mm]
M8 x 1.25	18.5 to 22.5	30.7

3. Front mounting

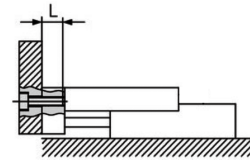

⚠ Caution If long bolts are used, they may touch the table and cause a malfunction, etc.

Bolt	Max. tightening torque [N·m]	Max. screw-in depth L [mm]
M10 x 1.5	29.5 to 34.5	19

4. Top mounting

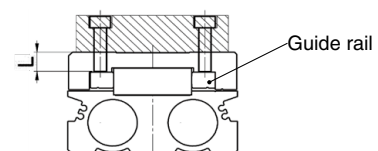

⚠ Caution In order to prevent the workpiece fixing bolt from hitting the guide rail, use a bolt of a length at least 0.5 mm shorter than the maximum screw-in depth. If long bolts are used, they may touch the guide rail and cause a malfunction, etc.

Bolt	Max. tightening torque [N·m]	Max. screw-in depth L [mm]
M8 x 1.25	15 to 18.5	12.5

- 10. The positioning holes on the table and on the bottom of the body do not have the same center. Use these holes during reinstallation after the table has been removed for the maintenance of an identical product.**

- 11. When the adjuster is mounted, a moment is generated by the cylinder thrust, causing displacement of the table end at stop.**

The displacement amount may vary depending on the supply pressure, mounting orientation, or model. For details, please contact your SMC sales representative.



MXQ32-X2600

Specific Product Precautions 2

Be sure to read this before handling the products. For safety instructions, actuator precautions, and auto switch precautions, refer to the “Handling Precautions for SMC Products” and the “Operation Manual” on the SMC website: <https://www.smcworld.com>

Operating Environment

⚠ Caution

- Do not use in environments where the product could be exposed to liquids, such as cutting oil, etc.**
Using in an environment where the product could be exposed to cutting oil, coolant, oil, etc., could result in looseness, increased operating resistance, air leakage, etc.
- Do not use in environments where the product could be exposed directly to foreign matter, such as powder dust, blown dust, cutting chips, spatter, etc.**
This could result in looseness, increased operating resistance, air leakage, etc. Please consult with SMC regarding use in this kind of environment.
- Do not use in direct sunlight.**
- When there are heat sources in the surrounding area, block them off.**
When there are heat sources in the surrounding area, radiated heat may cause the product's temperature to rise and exceed the operating temperature range. Block off the heat with a cover, etc.
- Martensitic stainless steel is used for the guide rail, and high carbon chromium steel (high carbon chromium bearing steel) is used for the guide block. However, the anti-corrosiveness of these steels is inferior to that of austenitic stainless steel. In particular, rust may be generated in environments where water droplets are likely to adhere due to condensation, etc.**
- Use caution for the anti-corrosiveness of the linear guide section.**
In particular, rust may be generated in environments where water droplets are likely to adhere due to condensation, etc.

Piping Port Plugs

⚠ Caution

- Plugs (with sealant) for the piping ports are included in the package, but they do not come assembled.**
- This product has 2 piping ports on each side. Refer to the operation manual and insert the plugs into any unused piping ports before using the product.**
- If a plug inserted into a piping port is removed, some of the sealant may peel off, and the seal performance may be affected. Refer to the operation manual for further details.**

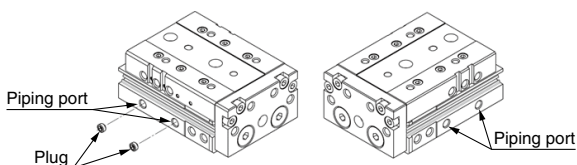

Adjuster Options

Adjuster

⚠ Caution

- Do not use with a bolt other than the original adjustment bolt.**
Using a different bolt could result in looseness and damage due to impact forces, etc.
- Use the tightening torque in the table below for the lock nuts.**
Insufficient torque will result in a decrease in positioning accuracy.

Tightening torque [N·m]
62 to 69

- When adjusting the adjuster, do not hit the table with the wrench.**
This could result in looseness.

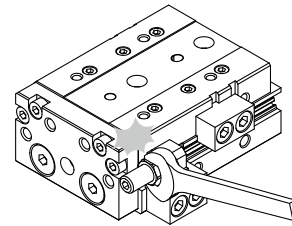

Shock Absorber

⚠ Caution

- Do not rotate the screw on the bottom surface of the shock absorber.**
This is not an adjusting screw. Turning it could cause oil leakage.
- Do not scratch the exposed portion of the piston rod.**
The durability may be affected and the piston may no longer operate properly.



- Use the tightening torque in the table below for the shock absorber lock nuts.**

Tightening torque [N·m]
8.8 to 10.8

Service Life and Replacement Period of Shock Absorber

⚠ Caution

- The allowable number of operating cycles under the specifications in this catalog is shown below.**

Shock absorber model	Specified service life*1
RJ1412LN	3 million cycles

*1 The specified service life (recommended replacement period) is the value at room temperature (20 to 25°C). The period may vary depending on the temperature and other conditions. In some cases, the absorber may need to be replaced before the allowable number of operating cycles stated above has been reached.



MXQ32-X2600

Specific Product Precautions 3

Be sure to read this before handling the products. For safety instructions, actuator precautions, and auto switch precautions, refer to the “Handling Precautions for SMC Products” and the “Operation Manual” on the SMC website: <https://www.smcworld.com>

Adjuster Option Mounting

⚠ Caution

1. Adjuster options are shipped together with the product.

Refer to the operation manual before starting installation, and perform installation according to the procedures described.

2. The bolt length of the body mounting part and the table mounting part are different.

Be aware that the hexagon socket head cap screws for the body mounting part, and the table mounting part of the adjuster on the extension end (AS, BS) are of different lengths. If assembled incorrectly, looseness or a malfunction may result.

1. Table mounting part (Adjuster on the extension end)

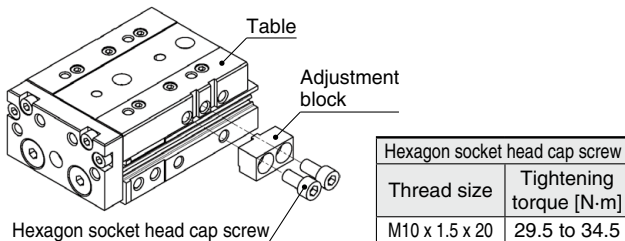

2. Body mounting part (Adjuster on the extension end)

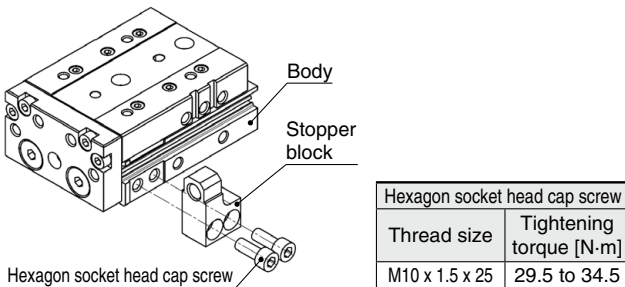

3. Table mounting part (Adjuster on the retraction end)

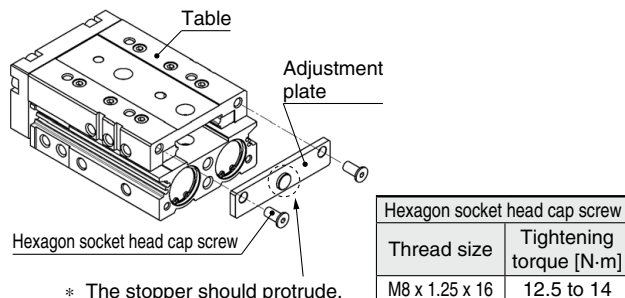

4. Body mounting part (Adjuster on the retraction end)

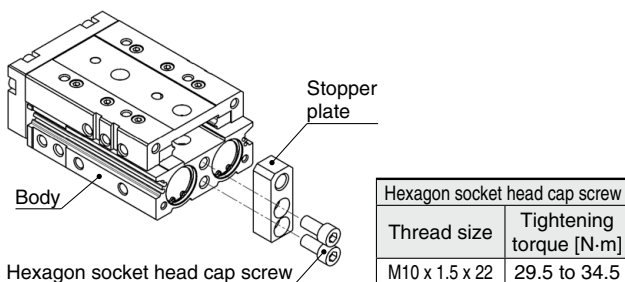

Other

⚠ Warning

1. Do not put your hands or fingers between the table and bracket.

Never put hands or fingers in the gap between the table and bracket when retracted. Doing so will result in injury.

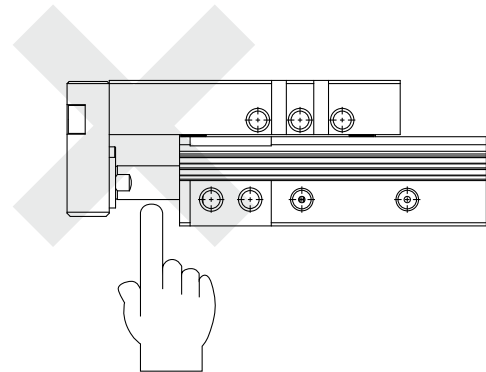

2. Be aware that smoking cigarettes, etc., after your hands have come into contact with the grease used in the cylinder section of this product can create a gas that is hazardous to humans.

⚠ Caution

1. Do not disassemble or modify the product.
2. Performance stability

The piston speed in the specification table shows the average speed. The actual speed of this product may vary slightly during the stroke depending on changes in the load resistance or pressure fluctuations.

If stable operation at a low speed is necessary, please contact your local SMC sales office.

 **Safety Instructions** Be sure to read the "Handling Precautions for SMC Products" (M-E03-3) and "Operation Manual" before use.

SMC Corporation

Akihabara UDX 15F,
4-14-1, Sotokanda, Chiyoda-ku, Tokyo 101-0021, JAPAN
Phone: 03-5207-8249 Fax: 03-5298-5362
<https://www.smcworld.com>
© 2023 SMC Corporation All Rights Reserved

Specifications are subject to change without prior notice
and any obligation on the part of the manufacturer.

D-G