

Exhaust Flow Control Valve with Indicator



Contributes to reduced setting errors and work hours by managing flow rate figures (indicator)

■ Integrated Restrictor and Silencer

Reduced assembly time and number of components

■ The speed can be adjusted on the valve side

It is difficult to adjust the speed if the cylinder is installed in a high or narrow place.

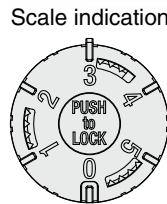
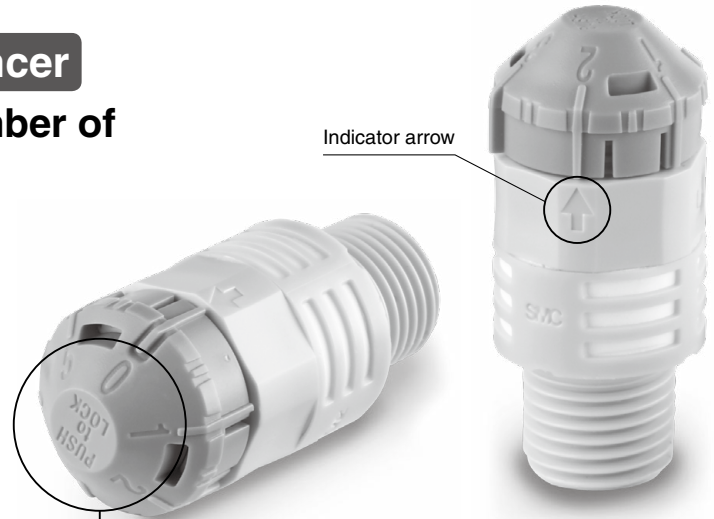
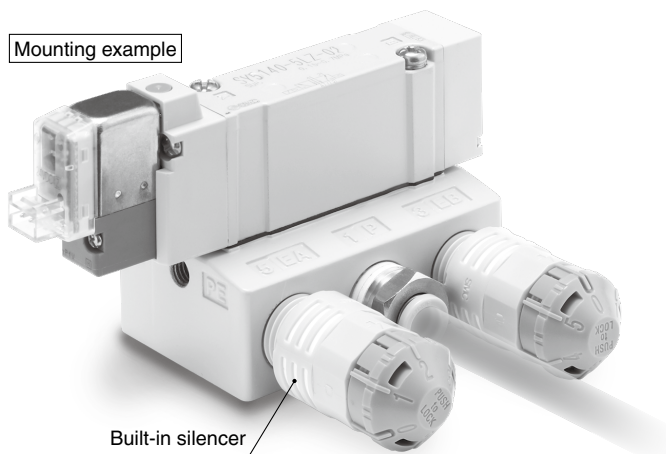

Scale indication	Flow rate [L/min (ANR)]
0	Approx. 50
1	Approx. 75
2	Approx. 130
3	Approx. 210
4	Approx. 300
5	Approx. 370

* The valves and fittings are available separately.

Flow Rate Characteristics

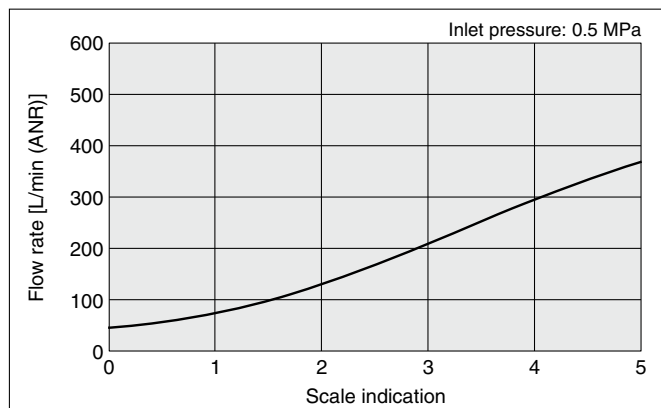

- *1 The flow rate characteristics are representative values.
- *2 This is a product at which there is flow at the indicator setting "0".
- *3 Specifications when the needle rotation corner is fully open at 300° (indicator 5)

Specifications

Fluid	Air
Proof pressure	1.5 MPa
Operating pressure range	0 to 1 MPa
Ambient and fluid temperatures	-5 to 60°C (No freezing)
Connection thread	R1/4

AS-DPX00042



21-E769

AS-DPX00042

Construction/Dimensions

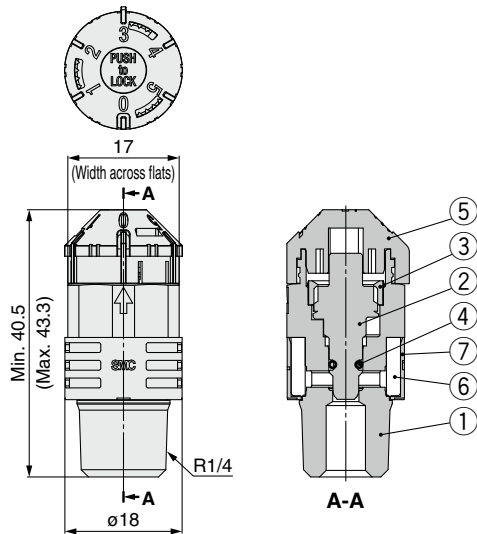

No.	Description	Material	Note
1	Body B	PBT	
2	Needle	PBT	
3	Needle guide	Brass	Electroless nickel plating
4	O-ring	NBR	
5	Knob	POM	
6	Silencer	PVA	
7	Silencer cover	PE	

⚠ Specific Product Precautions

Design and Selection

⚠ Warning

1. Example of inapplicable circuits

- (a) Perfect valve (VF66□□, VS7-6-FPG, VS7-8-FPG) (b) Pilot check valve between actuator and valve

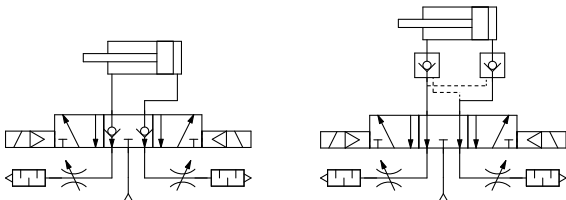

Residual pressure behind the exhaust needle may cause the check valve in the perfect valve to malfunction.

Residual pressure behind the exhaust needle may cause the pilot check valve to malfunction.

Mounting

⚠ Warning

Sealant tape is not required for piping.

After hand tightening, retighten body B an additional 1 to 2 rotations with an appropriate wrench until the indicator arrow can be easily seen.

(Reference tightening torque: 0.7 to 1.35 N·m)
Excessive tightening may damage the product.

Mounting

⚠ Warning

After pushing the knob down to lock, confirm that it is locked.

It should not be possible to rotate the knob to the right or left. If the knob is pulled with force, it may break. Therefore, do not pull the knob with excessive force.

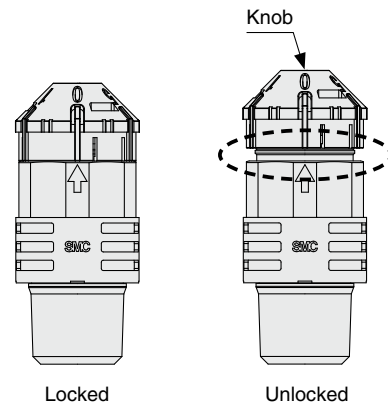

⚠ **Safety Instructions** Be sure to read the "Handling Precautions for SMC Products" (M-E03-3) and "Operation Manual" before use.